

SKF

MAINTENANCE AND LUBRICATION PRODUCTS

Extending the Bearing life cycle





Mounting and dismounting

Mechanical tools	10
Heating tools.	40
Hydraulic tools	56

Instruments

Alignment	86
Basic condition monitoring	108

Lubrication

Lubricants	144
Automatic grease dispensing tools	174
Manual grease dispensing tools	192
Accessories	198
Oil inspection and dispensing	203
Storage tools.	206
Lubrication analysis tools	208
Lubrication software	210



SKF Maintenance and Lubrication Products

Our mission is to maximize our customer bearing performance through effective lubrication and maintenance solutions.

The SKF Bearing Life Cycle

Help your bearing achieve its maximum service life

Every bearing has a certain service life potential. However, research has shown that, for various reasons, not every bearing achieves it. Important stages which have a major impact on a bearing service life can be recognised during the bearing's lifecycle. These stages are mounting, lubrication, alignment, basic condition monitoring and dismantling.

The stages in a bearing life cycle are extremely important for achieving the maximum service life of the bearing. By applying the right maintenance practices and using the correct tools, you can considerably extend your bearing's service life and increase plant productivity and efficiency.



Mounting

Includes mechanical fitting tools, induction heaters and hydraulic equipment

Mounting is one of the critical stages of the bearing's lifecycle. If the bearing is not mounted properly using the correct method and tools, the bearing's service lifetime will be reduced. Individual applications may require mechanical, heat or hydraulic mounting methods for correct and efficient bearing mounting. Selecting the correct mounting technique for your application will help you extend your bearing's service life and reduce costs resulting from premature bearing failure, as well as potential damage to the application.

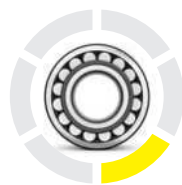

Lubrication

Includes bearing greases, manual and automatic lubricators and lubrication accessories

Correct bearing lubrication is an essential step in reaching the bearing's service lifetime. It is important to select grease suitable for the bearing's application, and to apply the correct quantity before commissioning the bearing. During operation, the bearing will require periodic relubrication. The right quantity of the right grease applied at the right intervals is essential to achieving optimum bearing performance and maximum service life. Using manual relubrication methods is common practice; however, continuous relubrication offers many advantages. It can be performed by using automatic lubricators, which provide a more consistent, correct and contamination-free grease supply.



Alignment

Includes shaft and belt alignment tools and machinery shims

After the bearing has been mounted in an application such as a motor connected to a pump, the application should be aligned. If the application is not properly aligned, the misalignment can cause the bearing to suffer additional load, friction and vibration. These can accelerate fatigue and reduce the bearing's, as well as other machine components, service life. Furthermore, increased vibration and friction can significantly increase energy consumption and the risk of premature failures.



Basic condition monitoring

Includes temperature, sound, visual inspection, speed, electrical discharge and vibration measuring instruments

During operation, it is important to regularly inspect the condition of the bearing by performing basic condition monitoring measurements. These regular inspections will allow the detection of potential problems and help to prevent unexpected machine stops. Consequently, the machine maintenance can be planned to suit the production schedule, increasing the plant's productivity and efficiency.

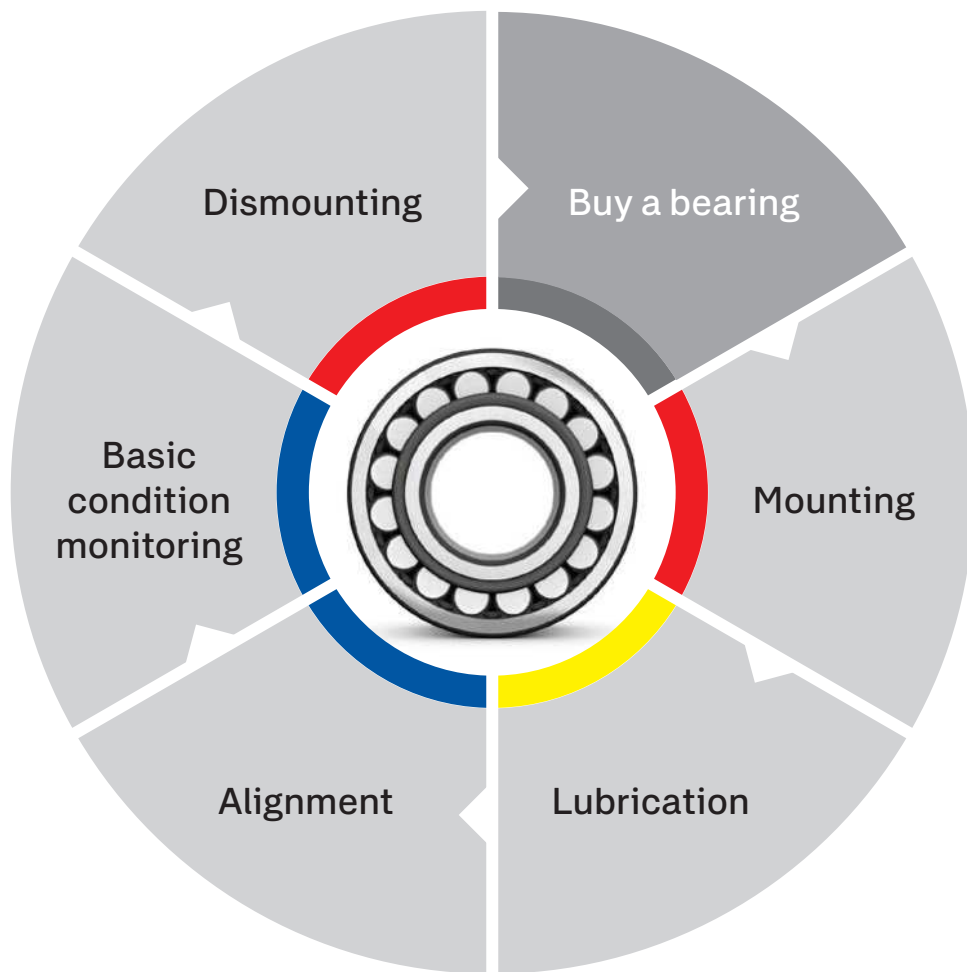

Dismounting

Includes pullers, both mechanical and hydraulic, induction heaters and hydraulic equipment

At some point, the bearing will reach the end of its service life and will have to be replaced. Although the bearing may not be used again, it is extremely important to dismount it correctly so that the service life of the replacement bearing is not compromised. Firstly, the use of proper dismounting methods tools will help prevent damage to other machine components, such as the shaft and housing, which are often re-used. Secondly, incorrect dismounting techniques can be hazardous to maintenance personnel.

Inside this catalogue, you will find SKF's complete range of maintenance and lubrication products which can help you get the maximum service life from your bearings. For more information about SKF maintenance and lubrication products or to order any of these products, please contact your local SKF authorised distributor or SKF sales company. On the Internet, SKF can be found at www.skf.com.

The importance of maintenance and lubrication

The importance of maintenance and lubrication on the total cost of ownership is often underestimated

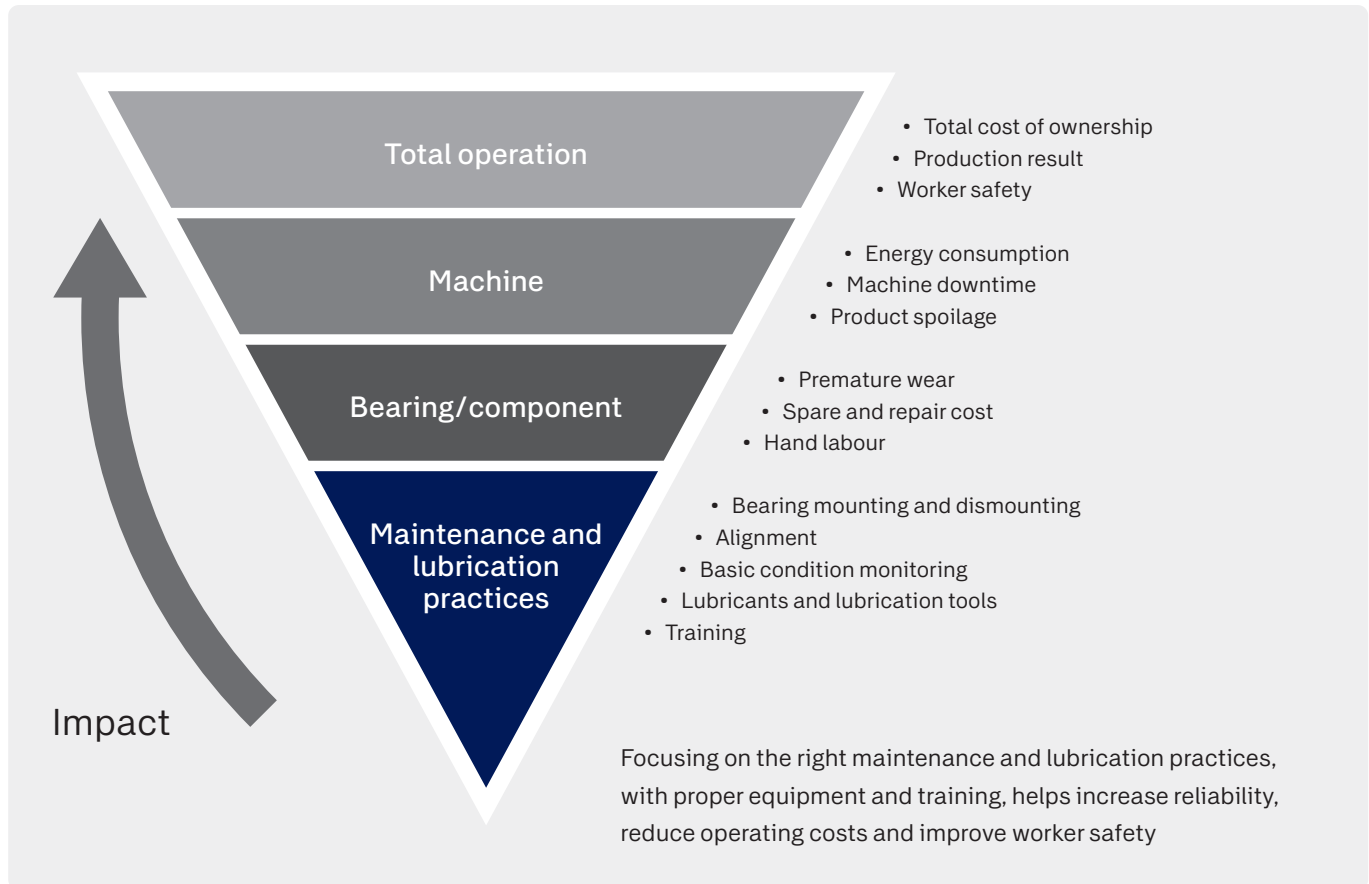

Thanks to SKF's unique knowledge of machinery operation and maintenance, we understand the issues that operators and maintenance personnel have to deal with every day.

With a focus on the bearing life cycle and machine operations, we develop and maintain a comprehensive product range to support you. Safety, ease of use, affordability and effectiveness are key product characteristics and drivers of our daily activities.

Continuous development and improvement of our products is made in cooperation with users and naturally we take account of regulatory bodies and applicable international standards to improve reliable rotating equipment performance and safety.

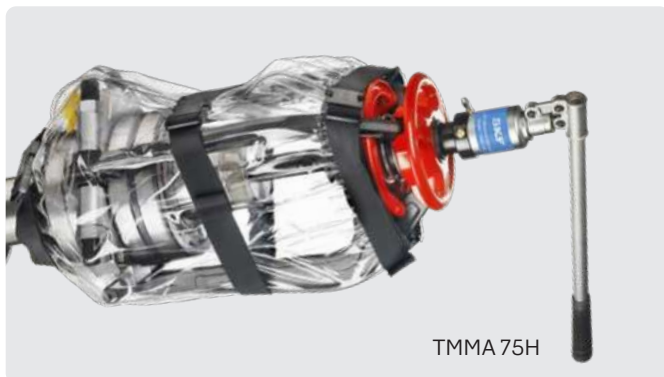

Main causes of premature bearing failures

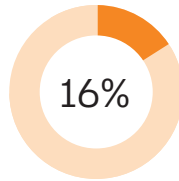

Poor fitting

Around 16% of all premature bearing failures are caused by poor fitting (usually brute force...) and maintenance personnel being unaware of the availability of the correct fitting tools. Individual installations may require mechanical, hydraulic or heat application methods for correct and efficient mounting or dismounting. SKF offers a complete range of tools and equipment to make these tasks easier, quicker and more cost effective, backed up by a wealth of service engineering know-how. Professional fitting, using specialised tools and techniques, is another positive step towards achieving maximum machine uptime.

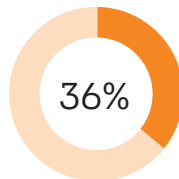

Poor lubrication

Although 'sealed-for-life' bearings can be fitted and forgotten, some 36% of premature bearing failures are caused by incorrect specification and inadequate application of the lubricant. Inevitably, any bearing deprived of proper lubrication will fail long before its normal service life. Because bearings are usually the least accessible components of machinery, neglected lubrication frequently compounds the problem. Wherever manual maintenance is not feasible, fully automatic lubrication systems can be specified by SKF for optimum lubrication. Effective lubrication and using only recommended SKF greases, tools and techniques helps to significantly reduce downtime.

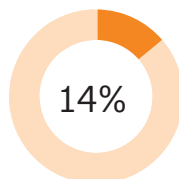

Contamination

A bearing is a precision component that will not operate efficiently unless both the bearing and its lubricants are isolated from contamination. And, since sealed-for-life bearings in ready-greased variants account for only a small proportion of all bearings in use, at least 14% of all premature bearing failures are attributed to contamination problems. SKF has an unrivalled bearing manufacturing and design capability and can tailor sealing solutions for the most arduous operating environments.

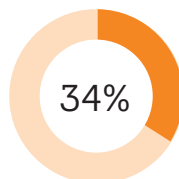

Fatigue

Whenever machines are overloaded, incorrectly serviced or neglected, bearings suffer from the consequences, resulting in 34% of all premature bearing failures. Sudden or unexpected failure can be avoided, since neglected or overstressed bearings emit 'early warning' signals which can be detected and interpreted using SKF condition monitoring equipment. The SKF range includes hand-held instruments, hard-wired systems and data management software for periodic or continuous monitoring of key operating parameters.



Poor bearing mounting techniques can significantly reduce the bearing service life.



Mounting and dismounting

Mechanical tools	10
Heating tools.	40
Hydraulic tools	56

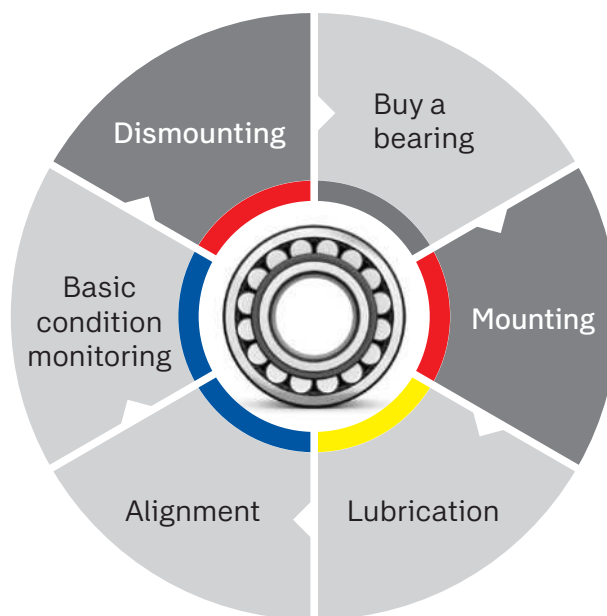

Mechanical tools

Bearing fitting tool kit TMFT 36.	10
Hook spanners HN series	12
Adjustable hook spanners HNA series	13
Hook spanners for SKF housings	14
Axial lock nut sockets TMFS series.	15
Impact spanners TMFN series	16
Bearing lock nut spanner TMHN 7 series	17
Combi kit TMMK series.	18
Mechanical pullers TMMMA series	22
Hydraulic pullers TMMMA ..H series	22
Hydraulic puller sets TMMMA ..H /SET series.	23
Standard jaw pullers TMMP series	24
Heavy duty jaw pullers TMMP series.	24
Hydraulically assisted heavy duty jaw pullers TMHP series	25
Reversible jaw puller TMMR F series.	26
Hydraulic jaw puller kit TMHP 10E	27
Hydraulic puller kit TMHC 110E	28
Strong back pullers TMBS E series.	29
Blind housing puller Kit TMBP 20E	30
Deep groove ball bearing puller kit TMMD 100	31
Internal bearing puller kits TMIP and TMIC series	32
Accessories	34

Heating tools

Electric hot plate 729659 C	41
Compact portable induction heater TMBH 5	42
Portable induction heater TWIM 15	43
Induction heater TIH 030m	45
Induction heater TIH 100m.	45
Induction heater TIH 220m	45
Induction heaters TIH L series	46
Induction heaters for non-bearing applications TIH L MB series	48
Multi-core induction heaters, TIH MC series	49
Aluminium heating rings TMBR series.	50
Fixed induction heater EAZ series	52
Accessories	54

Hydraulic tools

SKF Oil Injection Method	56
SKF Drive-up Method.	58
Hydraulic nut drive-up adapter HMVA 42/200	59
Hydraulic nuts HMV ..E series	60
Hydraulic pump and oil injector selection guide.	65
Hydraulic pump TMJL 50	66
Hydraulic pump 729124	66
Hydraulic pump TMJL 100	67
Hydraulic pump 728619 E	67
Hydraulic pump THHP 300	68
Oil injector 226400 E series.	69
Air-driven hydraulic pumps and oil injectors THAP E series .70	
Pressure gauges.	71
Accessories	72
OK Coupling mounting and dismounting kits	82

SKF methods and tools

Mounting

Around 16% of all premature bearing failures are a result of poor fitting or using incorrect mounting techniques. Selecting the correct mounting technique for your application will help you extend your bearing's service life and reduce costs resulting from premature bearing failure, as well as potential damage to the application.

Mounting bearings in a cold condition

Small and medium size bearings are generally cold mounted. Traditionally, the bearing is mounted using a hammer and a length of old pipe. SKF's fitting tool helps prevent bearing damage by applying the forces to the bearing ring with the interference fit.

Mounting bearings using heat

Oil baths are often used for heating bearings prior to mounting. However, this method can contaminate the bearing, resulting in premature bearing failure. Today, induction heating is the most common technique for heating bearings since it allows a high degree of controllability, efficiency and safety.

Mounting bearings using hydraulic techniques

SKF has pioneered the use of hydraulic techniques, such as the SKF Oil Injection Method and the SKF Drive-up Method, for mounting bearings.

These techniques have helped to simplify bearing arrangements and facilitate correct and easy mounting.

Dismounting

When dismantling bearings, care must be taken not to damage other machine components, such as the shaft or housing, as damage can compromise the machine's efficiency and lifetime. Individual applications may require mechanical, heat or hydraulic dismantling methods and tools to allow safe, correct and efficient bearing dismantling.

Mechanical dismantling

Choosing the right puller for the job is critical. The puller type, and its maximum withdrawal capacity are crucial for completing any dismantling job safely and easily. Whenever possible, apply the withdrawal force to the ring with the interference fit. SKF offers a complete range of easy-to-use mechanical, hydraulic and hydraulically-assisted bearing pullers for use in many bearing applications.

Dismounting using heat

The inner rings of cylindrical roller bearings generally have a tight interference fit, which requires high forces to dismount. Using heating equipment facilitates easy and quick dismantling while reducing the risk of damage to the ring and shaft. SKF offers a range of heating equipment for dismantling cylindrical roller bearing inner rings.

Dismounting bearings using hydraulic techniques

The SKF hydraulic techniques are often the preferred method for dismantling larger bearings as well as other components. These techniques, which employ hydraulic pumps, nuts and oil injectors, allow the application of substantial forces to dismount bearings or other components.



Online mounting and dismantling instructions

At skf.com/mount, SKF offers a unique web-based, free of charge information service for the mounting and dismantling of SKF bearings and bearing housings. This service provides step-by-step instructions for mounting and dismantling. The system also provides information on proper tools and lubricants. With this free internet service, SKF's expertise is at your fingertips around the clock worldwide.











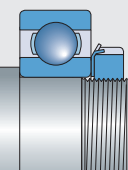

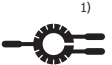





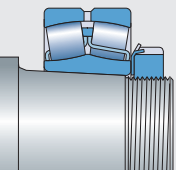



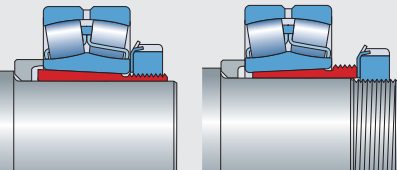

skf.com/mount

Shaft seatings

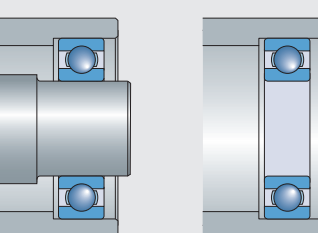
Mounting tools

Dismounting tools

		Mounting tools			Dismounting tools		
		Mechanical	Hydraulic	Heat	Mechanical	Hydraulic	Heat
Cylindrical seating 	Small bearings						 ¹⁾
	Medium bearings						 ¹⁾
	Large bearings						
Tapered seating 	Small bearings						
	Medium bearings						
	Large bearings						
Sleeve 	Small bearings						
	Medium bearings						
	Large bearings						
Housing 	Small bearings						
	Medium bearings						
	Large bearings						

Small bearings: bore diameter <55 mm (2.2 in.) / Medium bearings: bore diameter 55–200 mm (2.2-7.9 in.) / Large bearings: bore diameter >200 mm (>7.9 in.)

¹⁾ Only suitable for cylindrical bearings.



Fitting tool
page 10



Spanner
page 12



External puller
page 22



Internal and blind puller
page 30



Hot plate, induction heater
page 45

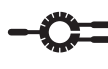

Aluminium heating ring
page 50



EAZ heater
page 52



Oil injection method
page 56



Drive-up method
page 58



Hydraulic nut and pump
page 60

Mechanical tools

Helps prevent premature bearing failures

Bearing fitting tool kit TMFT 36

Poor fitting, usually using brute force, accounts for 16% of premature bearing failures. The SKF Bearing Fitting Tool Kit is designed for quick and precise mounting of bearings, while minimising the risk of bearing damage. The right combination of impact ring and sleeve allows effective transmission of mounting force to the bearing ring with the interference fit, minimising the risk of damaging the bearing's raceways or rolling elements. In addition to mounting bearings, the TMFT 36 is also suitable for mounting other components such as bushings, seals and pulleys. The kit contains 36 impact rings, 3 impact sleeves and a dead-blow hammer packed in a lightweight carrying case.









- The TMFT 36 facilitates the mounting of a wide range of bearings with bore diameters from 10–55 mm
- Facilitates correct mounting on shaft, housing and blind applications
- The diameter of the impact ring precisely fits the inner and outer diameter of the bearing
- Small diameter of the impact area on top of the sleeve allows effective transmission and distribution of mounting force
- Impact rings and sleeves are made of high impact resistant material for longevity
- Click connection between impact ring and sleeve provides stability and durability
- The impact rings are suitable for use under a press
- Impact rings are marked for clear visual identification of the ring's size and easy selection
- Even surface of the impact sleeve's body provides excellent grip
- The nylon double-side head of the dead-blow hammer helps to prevent damaging the components
- The ergonomic handgrip of the dead-blow hammer provides excellent grip



Technical data

Designation	TMFT 36
Impact rings	
Bore diameter	10–55 mm (0.39–2.17 in.)
Outer diameter	26–120 mm (1.02–4.72 in.)
Sleeves	
Maximum shaft length	Sleeve A: 220 mm (8.7 in.) Sleeve B: 220 mm (8.7 in.) Sleeve C: 225 mm (8.9 in.)
Hammer	TMFT 36-H, weight 0.9 kg (2.0 lb)
Carrying case dimensions	530 × 110 × 360 mm (20.9 × 4.3 × 14.2 in.)
Number of rings	36
Number of sleeves	3
Weight (including carrying case)	4.4 kg (9.7 lb)

TMFT 36 is suitable for SKF bearing series

								
DGBB	DGBB (sealed)	SABB	SRACBB	DRACBB	SRB	CRB	TRB	CARB
6000 – 6011	62200 – 62211	1200 – 1211	7000 – 7011	3200 – 3211	21305 – 21311	N 1005 – N 1011	30203 – 30211	C 2205 – C 2211
6200 – 6211	62300 – 62311	129	7200 – 7211	3302 – 3311	22205/20	N 202 – N 211	30302 – 30311	C 4010
6300 – 6311	63000 – 63010	1301 – 1311	7301 – 7311		22205 – 22211	N 2203 – N 2211	31305 – 31311	C 6006
6403 – 6409		2200 – 2211			22308 – 22311	N 2304 – N 2311	32004 – 32011	
629		2301 – 2311				N 3004 – N 3011	32205 – 32211	
62/22		11207 – 11210				N 303 – N 311	32303 – 32311	
62/28							33010 – 33011	
63/22							33205 – 33211	
63/28								
16002 – 16011								
16100 – 16101								
98203 – 98206								

Interference fits on cylindrical shafts

Most bearings are fitted to their shaft or housing with one component having an interference fit. For determining the correct fit, refer to the SKF General Catalogue, the SKF Maintenance Handbook or consult an SKF application engineer.

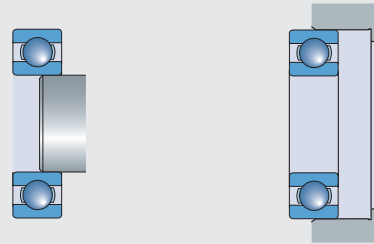

Shaft interference fit

Housing interference fit

Incorrect mounting

When bearings are mounted cold, care must be taken to ensure the drive-up forces are applied to the ring with the interference fit. Damage to the bearing resulting in a failure can occur if the mounting force is transmitted through the rolling elements causing damage to the raceways.

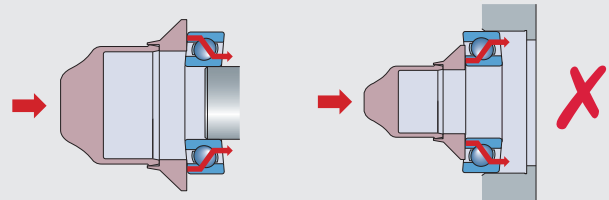

Uneven distribution of forces can result in raceway damage

Correct mounting

The correct way to minimise raceway damage is to use specifically designed tools from SKF, such as the Bearing fitting tool kit and Combi kits. These tools allow drive-up forces to be applied effectively and evenly to the component with the interference fit, avoiding raceway damage.

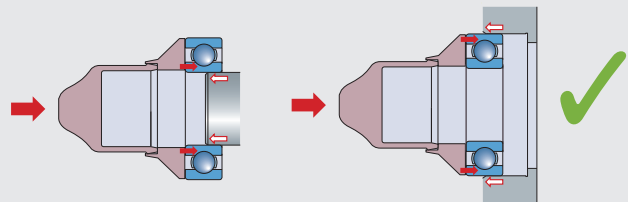

With the correct tools, raceway damage is avoided

Mechanical tools

Interference fits on tapered seatings

Bearings mounted on tapered seatings achieve their interference fit by being driven up the tapered seating. Care should be taken to ensure the bearing is not driven up too far, as all the internal clearance may be removed and damage to the bearing is possible.

Incorrect mounting

Bearing driven up too far and all clearance removed; damage possible.

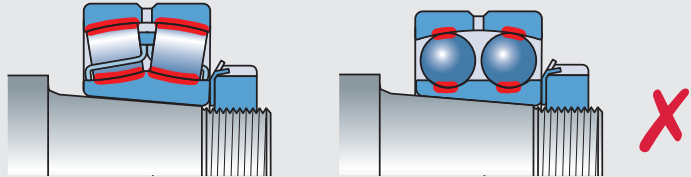

Correct mounting

Bearing driven up the correct distance and the right clearance is achieved.

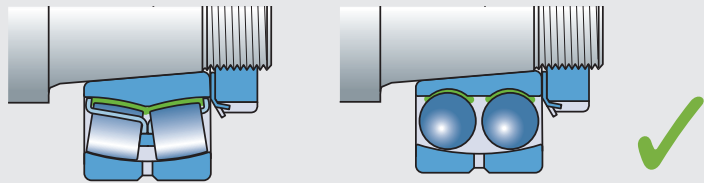

Spanners and sockets

The comprehensive range of SKF spanner and sockets are used to tighten and loosen many types and sizes of bearing lock nuts, for bearings mounted directly on a shaft or on sleeves. Depending on application and bearing size, SKF spanners and sockets can be used to drive a bearing up a tapered seating.

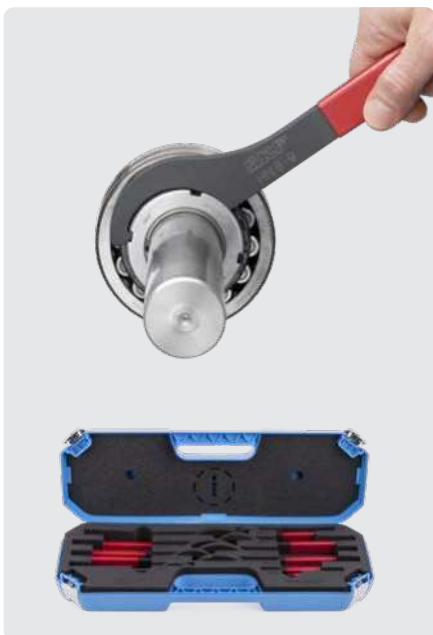

Exact spanner radius reduces the risk of nut damage

Hook spanners HN series

- Minimises the risk of shaft and nut damage
- Plastic handle is oil, grease and dirt resistant to provide a better grip
- The plastic handle minimises direct metal to skin contact, reducing the risk of corrosion in the handle area
- Spanner designation is laser-engraved allowing for easy identification and selection
- Available as a set: SKF HN 4-16/SET containing 9 spanners for lock nut sizes 4 up to 16
- Supplied in a sturdy carrying case

Contents HN 4-16/SET

HN 4	HN 8-9	HN 14
HN 5-6	HN 10-11	HN 15
HN 7	HN 12-13	HN 16

Selection chart – HN series

Designation	Suitable for the following series of SKF lock nuts						
	KM	N	AN	KMK	KMFE	KMT	DIN 1804 (M)
HN 0	0	0		0			M6×0.75, M8×1
HN 1	1	1		1			
HN 2-3	2, 3	2, 3		2, 3		0	M10×1, M12×1.5
HN 4	4	4		4	4	1, 2	M14×1.5, M16×1.5
HN 5-6	5, 6	5, 6		5, 6	5, 6	3, 4, 5	M22×1.5, M24×1.5, M26×1.5
HN 7	7	7		7	7	6, 7	M28×1.5, M30×1.5, M32×1.5, M35×1.5
HN 8-9	8, 9	8, 9		8, 9	8, 9	8	M38×1.5, M40×1.5, M42×1.5
HN 10-11	10, 11	10, 11		10, 11	10, 11	9, 10	M45×1.5, M48×1.5, M50×1.5
HN 12-13	12, 13	12, 13		12, 13	12, 13	11, 12	M52×1.5, M55×1.5, M58×1.5, M60×1.5
HN 14	14	14		14	14		
HN 15	15		15	15	15	13, 14	M62×1.5, M65×1.5, M68×1.5, M70×1.5
HN 16	16		16	16	16	15	
HN 17	17		17	17	17	16	M72×1.5, M75×1.5, M80×2
HN 18-20	18, 19, 20		18, 19, 20	18, 19, 20	18, 19, 20	17, 18, 19	M85×2, M90×2
HN 21-22	21, 22	022, 024	21, 22		22	20, 22, 24	M95×2, M100×2

Technical data – HN series

Designation	Spanner design DIN 1810		Outer diameter lock nut		Designation	Spanner design DIN 1810		Outer diameter lock nut	
	mm		mm	in.		mm		mm	in.
HN 0			16–20	0.6–0.8	HN 12-13	Ø80–Ø90		80–90	3.1–3.5
HN 1	Ø20–Ø22		20–22	0.8–0.9	HN 14			92	3.6
HN 2-3	Ø25–Ø28		25–28	1.0–1.1	HN 15	Ø95–Ø100		95–100	3.7–3.9
HN 4	Ø30–Ø32		30–32	1.2–1.3	HN 16			105	4.1
HN 5-6			38–45	1.5–1.8	HN 17	Ø110–Ø115		110–115	4.3–4.5
HN 7	Ø52–Ø55		52–55	2.0–2.2	HN 18-20	Ø120–Ø130		120–130	4.7–5.1
HN 8-9			58–65	2.3–2.6	HN 21-22	Ø135–Ø145		135–145	5.3–5.7
HN 10-11	Ø68–Ø75		68–75	2.7–3.0					



Four sizes for tightening or loosening up to 24 nut sizes

Adjustable hook spanners HNA series

- One hook spanner covers several nut sizes, making it suitable for use with many applications
- Economic solution: 4 hook spanners cover a wide range of nut sizes
- Laser engraved designation, which represents the range of nut sizes covered by each spanner, allows easy selection of the correct spanner
- Versatile: suitable for a wide selection of lock nuts
- Minimises the risk of shaft and nut damage

Selection chart and technical data – HNA series

Designation	Outer diameter lock nut		Suitable for the following series of SKF lock nuts						
	mm	in.	KM	KML	N	AN	KMK	KMFE	KMT
HNA 1-4	20–35	0.8–1.4	1–4		1–4		0–4	4	0–2
HNA 5-8	35–60	1.4–2.4	5–8		4–8		5–8	5–8	3–7
HNA 9-13	60–90	2.4–3.5	9–13		9–13		9–13	9–13	8–12
HNA 14-24	90–150	3.5–6.1	14–24	24–26	14, 022, 024	15–24	14–20	14–24	13–24

Mechanical tools



Easy and quick bearing mounting and dismounting in SNL housings

Hook spanners for SKF housings

- Unique design allows the HN /SNL series to be used inside SKF SNL, FSNL, SNH, SE and other SKF bearing housings
- Suitable for tightening and loosening KM, KML, N, AN, KMK, KMFE and KMT lock nuts, facilitating the use in a wide range of housing and shaft applications
- The large contact area of the spanner around the nut provides excellent grip
- Exact fit reduces the risk of shaft, nut and housing damage
- Designation is laser-engraved on the handle allowing easy identification and selection
- Easy storage with a hole in the handle for hanging up



Selection chart and technical data

Designation	Outer diameter lock nut		Suitable for SKF housings	Suitable for the following series of SKF lock nuts						
	mm	in.		SNL / FSNL / SNH / SE	KM	KML	N ¹⁾	AN ¹⁾	KMK ¹⁾	KMFE
HN 5/SNL	38	1.50	505, 506–605	5		5		5	5	3, 4
HN 6/SNL	45	1.77	506–605, 507–606	6		6		6	6	5
HN 7/SNL	52	2.05	507–606, 508–607	7		7		7	7	6, 7
HN 8/SNL	58	2.28	508–607, 510–608	8		8		8	8	
HN 9/SNL	65	2.56	509, 511–609	9		9		9	9	8
HN 10/SNL	70	2.76	510–608, 512–610	10		10		10	10	9
HN 11/SNL	75	2.95	511–609, 513–611	11		11		11	11	10
HN 12/SNL	80	3.15	512–610, 515–612	12		12		12	12	
HN 13/SNL	85	3.35	513–611, 516–613	13		13		13	13	11, 12
HN 15/SNL	98	3.86	515–612, 518–615	15			15	15	15	13, 14
HN 16/SNL	105	4.13	516–613, 519–616	16			16	16	16	15
HN 17/SNL	110	4.33	517, 520–617	17			17	17	17	16
HN 18/SNL	120	4.72	518–615	18			18	18	18	17
HN 19/SNL	125	4.92	519–616, 522–619	19			19	19	19	18
HN 20/SNL	130	5.12	520–617, 524–620	20		022	20, 21	20	20	19, 20
HN 22/SNL	145	5.71	522–619	22	24	024	22		22	22
HN 24/SNL	155	6.10	524–620	24, 25	26	026	24		24	24
HN 26/SNL	165	6.50	526	26, 27	28	028	26		26	26, 28
HN 28/SNL	180	7.09	528	28, 29	30, 32	030	28		28	30
HN 30/SNL	195	7.68	530	30, 31	34	034	30		30	32, 34
HN 32/SNL	210	8.27	532	32, 33	36, 38	036			32	36

¹⁾ Not recommended for use in combination with SNL/SNH housing



Easy mounting and dismounting without nut damage

Axial lock nut sockets TMFS series

- Requires less space around the bearing arrangement than hook spanners
- Inch connections for power tools or torque wrenches
- SKF TMFS fits nuts of series KM, KMK (metric) and KMF



Selection chart and technical data

Designation	Suitable for the following series of SKF lock nuts		Dimensions						
	KM, KMK	KMFE	Outer diameter lock nut		Outer diameter socket		Effective height		Drive connection
			mm	in.	mm	in.	mm	in.	in.
TMFS 0	0 ¹⁾		18	0.7	22,0	0.9	45	1.8	3/8
TMFS 1	1 ¹⁾		22	0.9	28,0	1.1	45	1.8	3/8
TMFS 2	2		25	1.0	33,0	1.3	61	2.4	1/2
TMFS 3	3		28	1.1	36,0	1.4	61	2.4	1/2
TMFS 4	4	4	32	1.3	38,0	1.5	58	2.3	1/2
TMFS 5	5	5	38	1.5	46,0	1.8	58	2.3	1/2
TMFS 6	6	6	45	1.8	53,0	2.1	58	2.3	1/2
TMFS 7	7	7	52	2.0	60,0	2.4	58	2.3	1/2
TMFS 8	8	8	58	2.3	68,0	2.7	58	2.3	1/2
TMFS 9	9	9	65	2.6	73,5	2.9	63	2.5	3/4
TMFS 10	10	10	70	2.8	78,5	3.1	63	2.5	3/4
TMFS 11	11	11	75	3.0	83,5	3.3	63	2.5	3/4
TMFS 12	12	12	80	3.1	88,5	3.5	63	2.5	3/4
TMFS 13	13	13	85	3.3	94,0	3.7	63	2.5	3/4
TMFS 14	14	14	92	3.6	103,0	4.1	80	3.2	1
TMFS 15	15	15	98	3.9	109,0	4.3	80	3.2	1
TMFS 16	16	16	105	4.1	116,0	4.6	80	3.2	1
TMFS 17	17	17	110	4.3	121,0	4.8	80	3.2	1
TMFS 18	18	18	120	4.7	131,0	5.2	80	3.2	1
TMFS 19	19	19	125	4.9	137,0	5.5	80	3.2	1
TMFS 20	20	20	130	5.1	143,0	5.7	80	3.2	1

¹⁾ KM 0 only

Mechanical tools



High impact forces without nut damage

Impact spanners TMFN series

- Designed for safely tightening and loosening a wide selection of larger lock nuts
- Not intended to be used to drive bearings up a tapered seating
- Helps avoid shaft and nut damage
- Safe and user friendly
- Impact applied effectively to the nut
- Special wide impact face
- To be used in combination with a hammer

Suitable for the following series of SKF lock nuts

Designation	KMT ..	KM ..	KML ..	KMFE ..	HM .. (HM .. E)	HM .. T	AN ..	N ..	DIN 1804 (M)
TMFN 23-30	24-30	23-31	26-32	24-28			AN22-AN28	N022-N032	M105x2-M130x3
TMFN 30-40	32-40	32-40	34-40	30-38			AN30-AN38	N034-N040	M140x3-M180x3
TMFN 40-52				40	3044-3052	42-48	AN40	N044-N052	N44 M190x3, M200x3
TMFN 52-64					3056-3064	3160		N056-N064	
TMFN 64-80					3068-3084	3164-3176		N068-N084	
TMFN 80-500					3088-3096	3180-3196	30/500	N088-N096	N500
TMFN 500-600					30/530-30/630	31/500-31/560		N530-N630	
TMFN 600-750					30/670-30/800	31/600-31/750		N670-N800	

Suitable for the following series of SKF adapter sleeves

Designation	H 23..	H 30..	H 31..	H32	H39
TMFN 23-30	H2324-H2332L	H3024E-H3032	H3124-H3130L		H3926-H3932
TMFN 30-40	H2332-H2340	H3030E, H3034-H3040	H3132-H3140L		H3934-H3940
TMFN 40-52	OH2344H, OH2348H	OH3044H-OH3052H	H3144H(HTL)-H3152HTL		H3944H-H3952H
TMFN 52-64	OH2352H, OH2356H	OH3056H-OH3064H	OH3152H-OH3160H	OH3260H	OH3956H-OH3964H
TMFN 64-80		OH3068H-OH3084H	OH3164H-OH3176H(E)	OH3264H-OH3276H	OH3968H-OH3984H(E)
TMFN 80-500		OH30/500H, OH3080H-OH3096H	OH3180H(E)-OH3196H(E)	OH3280H-OH3296H	OH39/500H(E), OH3988H-OH3996H(E)
TMFN 500-600		OH30/530H-OH30/630H	OH31/530H-OH31/560H(E)	OH32/500H-OH32/560H	OH39/530H(E)-OH39/630H(E)
TMFN 600-750		OH30/670H-OH30/800H(E)	OH31/600H-OH31/750H(E)	OH32/600H-OH32/750H	OH39/670H(E)-OH39/800H(E)

Technical data

Designation	d		f		h	
	mm	in.	mm	in.	mm	in.
TMFN 23-30	148	5.83	11.5	0.45	4.4	0.17
TMFN 30-40	193	7.60	13.5	0.53	5.3	0.21
TMFN 40-52	248	9.76	16	0.63	6.5	0.26
TMFN 52-64	316	12.44	19	0.75	8.5	0.33
TMFN 64-80	396	15.59	23	0.91	11	0.43
TMFN 80-500	516	20.31	28	1.10	13	0.51
TMFN 500-600	626	24.65	36	1.42	16	0.63
TMFN 600-750	746	29.37	40	1.57	19	0.75

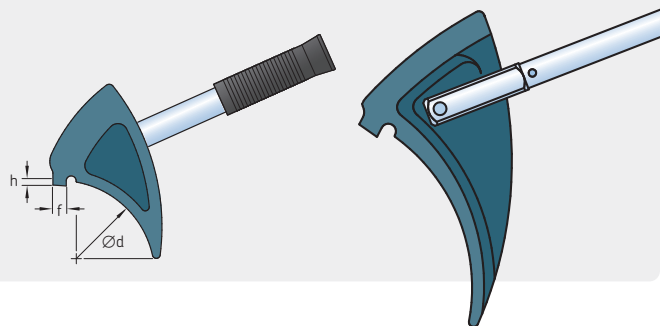



For achieving the correct radial clearance

Bearing lock nut spanner TMHN 7 series

The SKF TMHN 7 set of lock nut spanners is especially designed for mounting self-aligning ball bearings as well as small spherical roller and CARB toroidal roller bearings on tapered seatings. Using the SKF TMHN 7, minimises the risk of over-tightening of the lock nut, which can remove the bearing's radial clearance resulting in bearing damage.

- 7 different-sized spanners to fit nut sizes 5 to 11
- Each spanner is equipped with a protractor and is clearly marked with the correct tightening angle for mounting SKF Self aligning ball bearings
- 4 grip points on each spanner provide a better and safer grip on the nut
- Reduced risk of damaging bearing by over-tightening
- Suitable for use with lock nuts of the KM series either on shaft or in SNL housings
- Supplied in a carrying case

TMHN 7 is suitable for use with:

Bearing designation

1205 EK–1211 EK
 1306 EK–1311 EK
 2205 EK–2211 EK
 2306 K
 2307 EK–2309 EK
 2310 K–2311 K

Technical data

Designation

TMHN 7

Carrying case dimensions

345 × 255 × 85 mm
 (13.6 × 10.0 × 3.3 in.)

Weight

2.2 kg (4.7 lb)

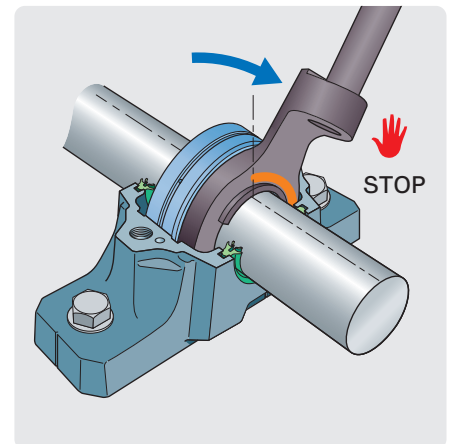
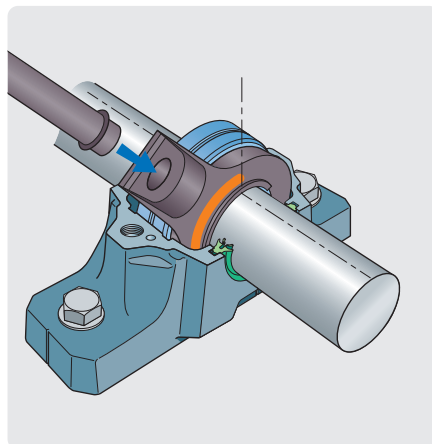
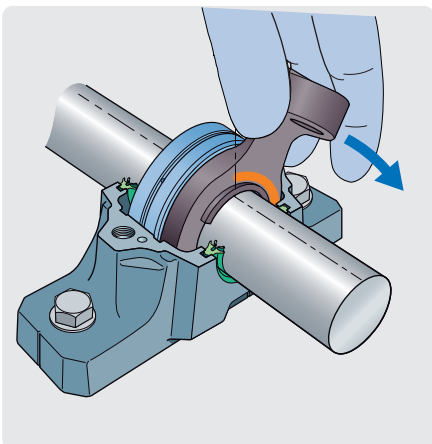

Mechanical tools

Multi-purpose kits for quick and easy mounting and dismounting

Combi kit TMMK series

The SKF TMMK series designed for the quick and precise mounting and dismounting of deep groove ball bearings from shafts, housings and blind housings. The TMMK 10-35 suits bearings with bore diameters from 10 to 35 mm, whereas the TMMK 20-50 suits bearings with bore diameters from 20 to 50 mm.

Multi-purpose fitting tools enable the mounting of a wide range of bearings and associated items. SKF deep groove ball bearings can be easily removed from blind housings and shafts, using a unique three-armed puller with a sliding hammer.



TMMK 10-35



TMMK 20-50

Mounting



Dismounting

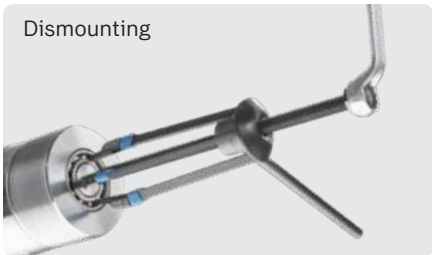

Dismounting











- The correct combination of impact ring and sleeve helps ensure that mounting forces are not transmitted via the rolling elements of the bearing, minimizing damage to bearing due to incorrect mounting
- The impact rings are made of high-impact modified polyamide. The impact sleeves are made of glass fibre-reinforced, high-impact modified polyamide, which is super-tough, strong and lightweight
- The dead-blow hammer has nylon faces and is steel-shot loaded for maximum impact. The handle, with comfortable rubber-grip for good handling, absorbs shock and vibration
- The claws are especially designed to facilitate a precise fit in the bearing's raceways, providing good grip and allowing the application of higher dismounting forces
- The designation is laser-engraved on the arms allowing easy identification and selection
- The springs are colour-coded allowing easy selection and matching
- Elastic locking ring results in easy connection of puller arms to spindle
- Heavy sliding weight of the sliding hammer generates a high dismounting force
- Heavy sliding weight of the sliding hammer generates a high dismounting force

Technical data









Designation	TMMK 10-35	TMMK 20-50
Number of impact rings	24	21
Number of sleeves	2	2
Impact rings bore diameter	10–35 mm (0.39–1.38 in.)	20–50 mm (0.79–1.97 in.)
Impact rings outer diameter	26–80 mm (1.02–3.15 in.)	42–110 mm (1.65–4.33 in.)
Dead-blow hammer	TMFT 36-H	TMFT 36-H
Dimensions of case	530 × 110 × 360 mm (20.9 × 4.3 × 14.2 in.)	530 × 110 × 360 mm (20.9 × 4.3 × 14.2 in.)
Weight	7.6 kg (16.8 lb)	8.5 kg (18.6 lb)

Mounting

TMMK 10-35 is suitable for SKF bearing series

 DGBB	 DGBB (sealed)	 SABB	 SRACBB	 DRACBB	 SRB	 CRB	 TRB	 CARB
6000 – 6007	62200 – 62207	1200 – 1207	7000 – 7007	3200 – 3207	21305 – 21307	N 1005 – N 1007	30203 – 30207	C 2205 – C 2207
6200 – 6207	62300 – 62307	129	7200 – 7207	3302 – 3307	22205/20	N 202 – N 207	30302 – 30307	C 6006
6300 – 6307	63000 – 63007	1301 – 1307	7301 – 7307		22205 – 22207	N 2203 – N 2207	31305 – 31307	
6403 – 6407		2200 – 2207				N 2304 – N 2307	32004 – 32007	
629		2301 – 2307				N 3004 – N 3007	32205 – 32207	
62/22		11207				N 303 – N 307	32303 – 32307	
62/28							33205 – 33207	
63/22								
63/28								
16002 – 16007								
16100 – 16101								
98203 – 98206								

TMMK 20-50 is suitable for SKF bearing series

 DGBB	 DGBB (sealed)	 SABB	 SRACBB	 DRACBB	 SRB	 CRB	 TRB	 CARB
6004 – 6010	62204 – 62210	1204 – 12010	7004 – 7010	3204 – 3210	21305 – 21310	N 1005 – N 1010	30204 – 30210	C 2205 – C 2210
6204 – 6210	62304 – 62310	1304 – 1310	7204 – 7210	3304 – 3210	22205/20	N 204 – N 210	30304 – 30310	C 4010
6304 – 6310	63004 – 63010	2204 – 2210	7304 – 7310		22205 – 22210	N 2204 – N 2210	31305 – 31310	C 6006
6404 – 6409		2304 – 2310			22308 – 22310	N 2304 – N 2310	32004 – 32010	
62/22		11207 – 11210				N 304 – N 310	32205 – 32210	
62/28							32304 – 32310	
63/22							33010	
63/28							33205 – 33210	
16004 – 16011								
98204 – 98206								

Dismounting

TMMK 10-35 is suitable for SKF bearing series



DGBB

6000 – 6017	6300 – 6307	16002 – 16003
6200 – 6211	63/22	16011
62/22	63/28	
62/28	6403	

TMMK 20-50 is suitable for SKF bearing series



DGBB







6004 – 6020	6300 – 6313	16011
6201 – 6218	63/22	
62/22	63/28	
62/28	6403 – 6310	



All parts are clearly arranged in the case for easy selection and identification.

Mechanical tools

Selection chart – SKF external and reversible pullers

	Designation	No. of arms	Width of grip	
			mm	in.
 <p>i 24</p>	SKF Standard Jaw Pullers			
	TMMP 2x65	2	15–65	0.6–2.6
	TMMP 2x170	2	25–170	1.0–6.7
	TMMP 3x185	3	40–185	1.6–7.3
	TMMP 3x230	3	40–230	1.6–9.0
	TMMP 3x300	3	45–300	1.8–11.8
 <p>i 26</p>	SKF Reversible Jaw Pullers			
	TMMR 40F	2	23–48	0.9–1.9
	TMMR 60F	2	23–68	0.9–2.7
	TMMR 80F	2	41–83	1.6–3.3
	TMMR 120F	2	41–124	1.6–4.9
	TMMR 160F	2	68–164	2.7–6.5
	TMMR 200F	2	65–204	2.6–8.0
	TMMR 250F	2	74–254	2.9–10.0
	TMMR 350F	2	74–354	2.9–13.9
	TMMR 160XL	2	42–140	1.7–5.5
	TMMR 200XL	2	42–180	1.7–7.1
	TMMR 250XL	2	44–236	1.7–9.3
TMMR 350XL	2	44–336	1.7–13.2	
 <p>i 24</p>	SKF Heavy Duty Jaw Pullers			
	TMMP 6	3	50–127	2.0–5.0
	TMMP 10	3	100–223	3.9–8.7
	TMMP 15	3	140–326	5.5–12.8
 <p>i 22</p>	Mechanical pullers SKF EasyPull			
	TMMA 60	3	36–150	1.4–5.9
	TMMA 80	3	52–200	2.0–7.8
	TMMA 120	3	75–250	3.0–9.8
	Hydraulic pullers SKF EasyPull			
	TMMA 75H + .../SET	3	52–200	2.0–7.8
TMMA 100H + .../SET	3	75–250	3.0–9.8	
 <p>i 27, 28</p>	SKF Hydraulic Jaw Puller Kit			
	TMHP 10E	3 × 3	75–280	3.0–11.0
 <p>i 27, 28</p>	SKF Hydraulic Puller Kit			
	TMHC 110E	2 × 3	50–170	1.9–6.7
 <p>i 25</p>	SKF Hydraulically Assisted Heavy Duty Jaw Pullers			
	TMHP 15/260	3	195–386	7.7–15.2
	TMHP 30/170	3	290–500	11.4–19.7
	TMHP 30/350	3	290–500	11.4–19.7
	TMHP 30/600	3	290–500	11.4–19.7
	TMHP 50/140	3	310–506	12.2–19.9
	TMHP 50/320	3	310–506	12.2–19.9
	TMHP 50/570	3	310–506	12.2–19.9

¹⁾ Other arm length options are available

Effective arm length		Maximum withdrawal force	
mm	in.	kN	US ton
60	2.4	6	0.7
135	5.3	18	2.0
135	5.3	24	2.7
210	8.3	34	3.8
240	9.4	50	5.6
67	2.6	17	1.91
82	3.2	17	1.91
98	3.9	40	4.5
124	4.9	40	4.5
143	5.6	50	5.6
169	6.7	50	5.6
183	7.2	60	6.7
238	9.4	60	6.7
221	8.7	50	5.6
221	8.7	50	5.6
221	8.7	60	6.7
221	8.7	60	6.7
120 ¹⁾	4.7 ¹⁾	60	6.7
207 ¹⁾	8.2 ¹⁾	100	11.2
340 ¹⁾	13.4 ¹⁾	150	17
150	5.9	60	6.7
200	7.8	80	9.0
250	9.8	120	13.5
200	7.8	75	8.4
250	9.8	100	11.2
115–200	4.4–7.9	100	11.2
70–120	2.8–4.7	100	11.2
264 ¹⁾	10.4 ¹⁾	150	17
170 ¹⁾	6.7 ¹⁾	300	34
350 ¹⁾	13.7 ¹⁾	300	34
600 ¹⁾	23.6 ¹⁾	300	34
140 ¹⁾	5.5 ¹⁾	500	56
320 ¹⁾	12.6 ¹⁾	500	56
570 ¹⁾	22.4 ¹⁾	500	56

SKF supplies a wide range of pullers for the dismantling of bearings. Depending on the arrangement they can also be used to pull couplings, gear wheels, and other machinery components from a shaft.

There are three main types of pullers:

External pullers

This is the most commonly used type of puller for removing bearings from shafts. The puller arms reach behind the bearing outer ring and by rotating the spindle the bearing can be removed. Depending on type, external pullers are typically supplied with two or three arms. External pullers can also be supplied with a separator that locates behind component to be removed, typically for applications where there is insufficient space for the puller arms. For very heavy loads, or for ease of use, some external pullers are supplied with hydraulic power options that greatly reduce the manual effort in removing the component.

Internal pullers

Internal pullers reach through the bore of a component and grip it from the inside. The dismantling force is often generated by a slide hammer. In general, this type of puller cannot be used on large components. Reversible jaw pullers are a versatile solution for the internal and external pulling of bearings and other components. Typically, they consist of a beam, spindle and two arms. These pullers are very popular for use in mobile service trucks, as they generally lighter and more compact than three arm external pullers.

Blind housing pullers

Blind housing pullers are attached to the bearing between the two bearing rings. SKF blind housing pullers are only to be used on SKF Deep Groove Ball bearings. Other bearing brands have bearings with different raceway geometries and therefore the fixing of the arms cannot be guaranteed.

When selecting a puller ensure that the puller opens sufficiently to grip the component and that there is enough space around the component to attach the puller.

It is strongly advised to select a puller that can generate a higher maximum force than is required by the application. The required pulling force depends on the mating surface area, the interference fit, the way of attaching the puller and other influences such as fretting corrosion.

Mechanical tools

SKF EasyPull

Equipped with spring-operated arms and a solid design, the SKF EasyPull is one of the most user-friendly and safe tools on the market. Ergonomically designed, the spring-operated arms enable the user to position the puller behind the component with just one movement. The SKF EasyPull is available in mechanical and hydraulically assisted versions, as well as complete kits with a tri-section pulling plate and a puller protection blanket.



Safe and simple bearing dismounting

Mechanical pullers TMMA series

- Sturdy design allows dismounting of components even in the tightest application in a safe manner
- The unique red rings spring-operated opening mechanism allows the SKF EasyPull to be placed behind the component with one movement of the hands
- Self-locking arms help prevent the risk of puller slipping under load
- Double hexagonal heads allow easier application of withdrawal force
- Self-centring capability and nosepiece help avoid damage to shaft
- Efficient use of time due to quick dismounting
- Available in three sizes with a withdrawal force of 60, 80 or 120 kN (6.7, 9.0 or 13.5 US ton), enabling easy selection
- TMHS series hydraulic force generators are available as an accessory for the 80 and 120 kN versions
- Supplied with a tube of puller spindle grease (LGEV 2)

Quick and virtually effortless bearing dismounting

Hydraulic pullers TMMA ..H series

- Ready-to-use, integrated hydraulic cylinder, pump and puller – thus it is assembly-free and it is not necessary to purchase separate parts
- Safety valve prevents spindles and pullers from being overloaded if excessive force is applied
- The spring-loaded centre point on the hydraulic spindle allows easy centring of the puller on the shaft without damaging the shaft
- The TMMA 100H has a maximum withdrawal force of 100 kN (11.2 US ton) and a long stroke of 80 mm (3.1 in.), which facilitates most dismounting jobs in just one operation
- For dismounting jobs requiring less force, SKF offers a 75 kN (8.4 US ton) version, the hydraulic EasyPull TMMA 75H with a maximum stroke of 75 mm (3 in.)
- Supplied with extension pieces and one nosepiece

Technical data

Designation	TMMA 60	TMMA 80	TMMA 120	TMMA 75H	TMMA 100H
Width of grip external, minimum	36 mm (1.4 in.)	52 mm (2.0 in.)	75 mm (3.0 in.)	52 mm (2 in.)	75 mm (3 in.)
Width of grip external, maximum	150 mm (5.9 in.)	200 mm (7.8 in.)	250 mm (9.8 in.)	200 mm (7.8 in.)	250 mm (9.8 in.)
Effective arm length	150 mm (5.9 in.)	200 mm (7.8 in.)	250 mm (9.8 in.)	200 mm (7.8 in.)	250 mm (9.8 in.)
Maximum withdrawal force	60 kN (6.7 US ton)	80 kN (9.0 US ton)	120 kN (13.5 US ton)	75 kN (8.4 US ton)	100 kN (11.2 US ton)
Claw height	7.5 mm (0.30 in.)	9.8 mm (0.39 in.)	13.8 mm (0.54 in.)	9.8 mm (0.39 in.)	13.8 mm (0.54 in.)
Hydraulic spindle	–	–	–	TMHS 75	TMHS 100
Adapter: possible to upgrade to hydraulic version	–	TMHS 75	TMHS 100	–	–
Total weight	4.0 kg (8.8 lb)	5.7 kg (12.6 lb)	10.6 kg (23.4 lb)	7.0 kg (15.4 lb)	13.2 kg (29 lb)



A complete bearing dismounting solution

Hydraulic puller sets TMMA ..H /SET series

- A set consisting of a hydraulically assisted SKF EasyPull together with a tri-section pulling plate, TMMS series, and a puller protection blanket facilitate an easy, safe and virtually damage-free dismounting
- Especially suitable for dismounting spherical roller and CARB toroidal roller bearings, and other components such as pulleys and flywheels
- A puller protection blanket, TMMX series, made of a strong transparent material allows the user to visually follow the dismounting procedure. While dismounting, the blanket helps to protect from flying fragments of bearings or other components, thereby enhancing user safety
- A sturdy custom-made storage case with room for all parts minimises the risk of losing or damaging the set's components

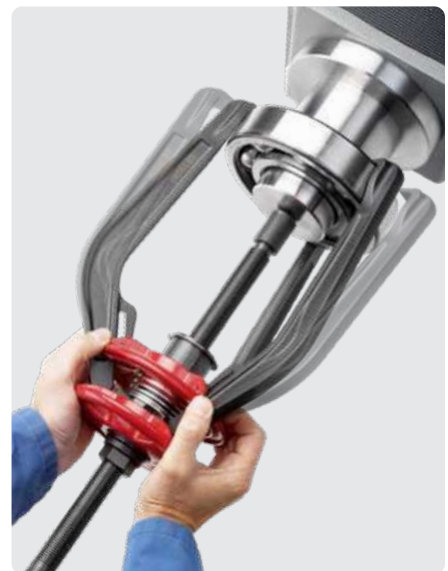
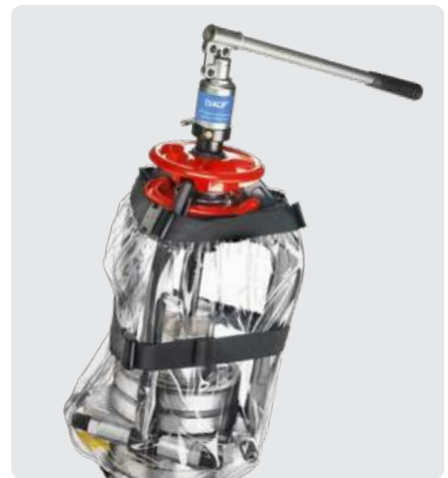

Technical data

Designation	TMMA 75H/SET	TMMA 100H/SET
Puller	TMMA 75H	TMMA 100H
Tri-section pulling plate	TMMS 100	TMMS 160
Puller protection blanket	TMMX 280	TMMX 350
Dimensions of case	600 × 235 × 225 mm (23.6 × 9.3 × 8.6 in.)	680 × 320 × 270 mm (27 × 13 × 11 in.)
Total weight	15.0 kg (33.1 lb)	31.6 kg (70 lb)

Mechanical tools

Jaw pullers

One of the most common ways to dismount small to medium size bearings is to use a basic mechanical puller. Using an SKF puller helps to safeguard against damage to the bearing or to the bearing seating during dismounting. SKF Jaw pullers allow for easy and safe puller operation.



Versatile two and three arm mechanical pullers

Standard jaw pullers TMMP series

- Range of five different jaw pullers with two or three arms
- Maximum nominal span from 65 to 300 mm (2.6 to 11.8 in.)
- Cone system for automatic centring and secure positioning of arms
- Strong springs keep arms apart for easy operation
- Hardened, high quality carbon steel

Powerful self-centring mechanical pullers

Heavy duty jaw pullers TMMP series

- Fast, efficient and smooth handling
- Unique pantograph system gives exceptional grip and helps counteract misalignment during operation
- Three arm jaw pullers with a maximum withdrawal force of 60 to 150 kN (6.7 to 17.0 US ton) suitable for medium to large size bearings
- Blackened, high quality steel for corrosion resistance
- Other arm length options are available

Technical data – SKF Standard Jaw Pullers

Designation	TMMP 2x65	TMMP 2x170	TMMP 3x185	TMMP 3x230	TMMP 3x300
No. of arms	2	2	3	3	3
Width of grip	15–65 mm (0.6–2.6 in.)	25–170 mm (1.0–6.7 in.)	40–185 mm (1.6–7.3 in.)	40–230 mm (1.6–9.1 in.)	45–300 mm (1.8–11.8 in.)
Effective arm length	60 mm (2.4 in.)	135 mm (5.3 in.)	135 mm (5.3 in.)	210 mm (8.3 in.)	240 mm (9.4 in.)
Claw height	8 mm (0.31 in.)	9 mm (0.35 in.)	9 mm (0.35 in.)	9 mm (0.35 in.)	11 mm (0.43 in.)
Maximum withdrawal force	6.0 kN (0.7 US ton)	18.0 kN (2 US ton)	24.0 kN (2.7 US ton)	34.0 kN (3.8 US ton)	50.0 kN (5.6 US ton)
Weight	0.5 kg (1.2 lb)	2.1 kg (4.7 lb)	2.9 kg (6.4 lb)	5.8 kg (13 lb)	8.6 kg (19 lb)

Technical data – SKF Heavy Duty Jaw Pullers

Designation	TMMP 6	TMMP 10	TMMP 15
Width of grip	50–127 mm (2.0–5.0 in.)	100–223 mm (3.9–8.7 in.)	140–326 mm (5.5–12.8 in.)
Effective arm length	120 mm (4.7 in.)	207 mm (8.2 in.)	340 mm (13.4 in.)
Claw height	15 mm (0.59 in.)	20 mm (0.78 in.)	30 mm (1.18 in.)
Maximum withdrawal force	60 kN (6.7 US ton)	100 kN (11.2 US ton)	150 kN (17 US ton)
Weight	4.0 kg (8.8 lb)	8.5 kg (19 lb)	21.5 kg (47.4 lb)
Effective length optional arms			
TMMP ..-1	included	included	260 mm (10.2 in.)
TMMP ..-2	220 mm (8.6 in.)	350 mm (13.8 in.)	included
TMMP ..-3	370 mm (14.5 in.)	460 mm (18.1 in.)	435 mm (17.1 in.)
TMMP ..-4	470 mm (18.5 in.)	710 mm (27.9 in.)	685 mm (27.0 in.)

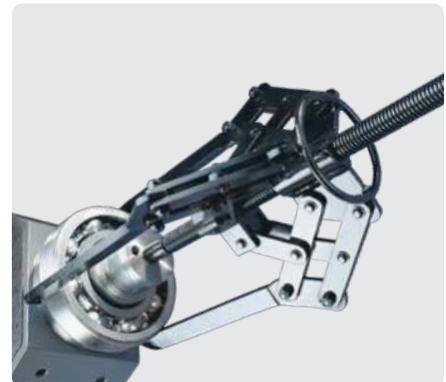

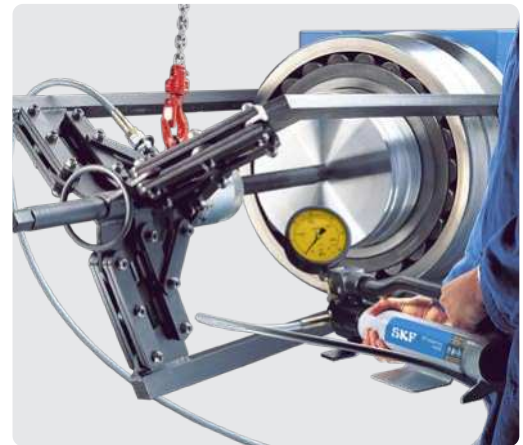
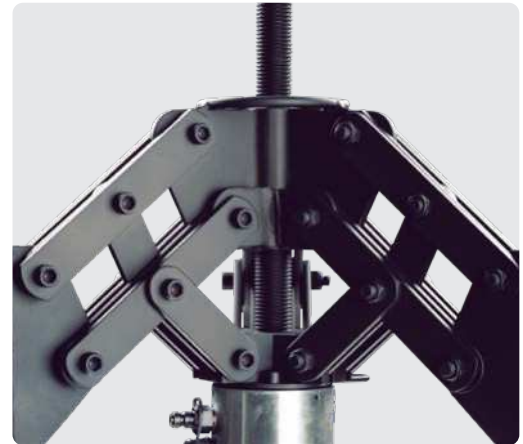

Powerful self-centring hydraulic pullers

Hydraulically assisted heavy duty jaw pullers TMHP series

- High forces can be easily applied as the puller is self-centring
- The combination of a spindle and hydraulic cylinder allows the working length to be easily adjusted
- Unique pantograph system gives exceptional grip and helps counteract misalignment during operation
- Equipped with a lifting handle and eye bolt, facilitates easy handling
- Maximum withdrawal force of 150, 300 or 500 kN (17, 34 or 56 US ton)
- Supplied with SKF Hydraulic Pump TMJL 100

Technical data							
Designation ¹⁾	TMHP 15/260	TMHP 30/170	TMHP 30/350	TMHP 30/600	TMHP 50/140	TMHP 50/320	TMHP 50/570
Width of grip	195–386 mm (7.7–15.2 in.)	290–500 mm (11.4–19.7 in.)	290–500 mm (11.4–19.7 in.)	290–500 mm (11.4–19.7 in.)	310–506 mm (12.2–19.9 in.)	310–506 mm (12.2–19.9 in.)	310–506 mm (12.2–19.9 in.)
Effective arm length	264 mm (10.4 in.)	170 mm (6.7 in.)	350 mm (13.7 in.)	600 mm (23.6 in.)	140 mm (5.5 in.)	320 mm (12.6 in.)	570 mm (22.4 in.)
Claw height	30 mm (1.2 in.)	35 mm (1.4 in.)	35 mm (1.4 in.)	35 mm (1.4 in.)	40 mm (1.6 in.)	40 mm (1.6 in.)	40 mm (1.6 in.)
Stroke	100 mm (3.9 in.)	50 mm (2 in.)	50 mm (2 in.)	50 mm (2 in.)	40 mm (1.6 in.)	40 mm (1.6 in.)	40 mm (1.6 in.)
Maximum working pressure hydraulic cylinder	80 MPa (11 600 psi)	80 MPa (11 600 psi)	80 MPa (11 600 psi)	80 MPa (11 600 psi)	80 MPa (11 600 psi)	80 MPa (11 600 psi)	80 MPa (11 600 psi)
Maximum withdrawal force	150 kN (17 US ton)	300 kN (34 US ton)	300 kN (34 US ton)	300 kN (34 US ton)	500 kN (56 US ton)	500 kN (56 US ton)	500 kN (56 US ton)
Weight	31 kg (68 lb)	49 kg (108 lb)	53.5 kg (118 lb)	58 kg (128 lb)	59.5 kg (131 lb)	65 kg (143 lb)	72 kg (159 lb)

¹⁾ Also available without hydraulic pump TMJL 100 (Weight: 7 kg (15.4 lb)). Please add suffix 'X' to designation when ordering without pump (e.g. TMHP 30/170X).

Mechanical tools

Versatile and robust pullers for internal and external pulling jobs

Reversible jaw puller TMMR F series

The multi-purpose SKF Reversible jaw pullers are suitable for internal and external pulling of bearings and other components. The standard range of eight pullers can accommodate a wide range of bearing and component sizes. The four largest TMMR...F pullers are also available with extra long arms as a standard option (TMMR...XL). The extra long arms help to dismount bearings and components placed far from the shaft end and can be further extended by adding extension pieces.



TMMR..XL with 2 optional extension pieces

- An essential and versatile tool for every workshop allows for external and internal pulling applications
- Self-locking arms for easy adjustment of width of grip
- Hexagonal head on beam enables rotation of puller and bearing during dismounting, improving ease of use
- Wide gripping range from 23 mm (0.9 in.) internal to 350 mm (13.8 in.) external, enables many bearings and components to be dismounted
- Unlike many similar pullers, the pullers can be used up to their full rated load capacity without permanently deforming the puller arms
- Arms and beam are zinc passivated for enhanced corrosion resistance and easy cleaning
- The extra long arm extension pieces, designed to be easy to fit and remove, can be used to further increase the effective arm length. Using extension pieces does not compromise the overall puller strength
- The SKF Reversible Jaw Pullers can also be supplied as three different sets, complete with a workshop stand



Technical data

		Designation	Width of grip external pull (D)		Width of grip internal pull (d)		Effective arm length (L)		Maximum withdrawal force	
External pull	Internal pull		mm	in.	mm	in.	mm	in.	kN	US ton
		TMMR 40F	23-48	0.9-1.9	59-67	2.3-2.6	67	2.6	17	1.9
		TMMR 60F	23-68	0.9-2.7	62-87	2.4-3.4	82	3.2	17	1.9
		TMMR 80F	41-83	1.6-3.3	95-97	3.7-3.8	98	3.9	40	4.5
		TMMR 120F	41-124	1.6-4.9	95-139	3.7-5.5	124	4.9	40	4.5
		TMMR 160F	68-164	2.7-6.5	114-163	4.5-6.4	143	5.6	50	5.6
		TMMR 200F	65-204	2.6-8.0	114-204	4.5-8.0	169	6.7	50	5.6
		TMMR 250F	74-254	2.9-10.0	132-254	5.2-9.9	183	7.2	60	6.7
		TMMR 350F	74-354	2.9-13.9	135-354	5.3-13.8	238	9.4	60	6.7
		TMMR 160XL	42-140	1.7-5.5	121-188	4.8-7.4	221 ¹⁾	8.7 ¹⁾	50	5.6
		TMMR 200XL	42-180	1.7-7.1	121-228	4.8-9.0	221 ¹⁾	8.7 ¹⁾	50	5.6
		TMMR 250XL	44-236	1.7-9.3	123-284	4.8-11.2	221 ¹⁾	8.7 ¹⁾	60	6.7
		TMMR 350XL	44-336	1.7-13.2	123-384	4.8-15.1	221 ¹⁾	8.7 ¹⁾	60	6.7

¹⁾ Arm length can be increased by (a multiple of) 125 mm (4.9 in.) with the arm extenders TMMR 16/35XL-4.

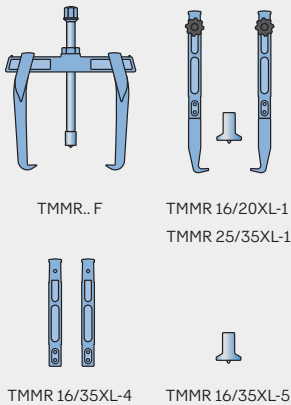

Contents

Designation	TMMR 4F/SET	TMMR 8F/SET	TMMR 8XL/SET
Puller TMMR 40F	—	•	•
Puller TMMR 60F	•	•	•
Puller TMMR 80F	—	•	•
Puller TMMR 120F	•	•	•
Puller TMMR 160F	•	•	•
Puller TMMR 200F	—	•	•
Puller TMMR 250F	•	•	•
Puller TMMR 350F	—	•	•
Extra long arm set 160F → 160XL, 200F → 200XL	—	—	•
Extra long arm set 250F → 250XL, 350F → 350XL	—	—	•
Spring-loaded nose piece	—	•	•



Accessories

TMMR 16/20XL-1	Extra long arm set (2 pcs) to convert TMMR 160F and TMMR 200F to XL version + spring-loaded nose piece
TMMR 25/35XL-1	Extra long arm set (2 pcs) to convert TMMR 250F and TMMR 350F to XL version + spring-loaded nose piece
TMMR 16/35XL-4	Extension arms set (2 pcs) for the TMMR.. XL (length 125 mm (4.9 in.))
TMMR 16/35XL-5	Spring-loaded nose piece



Effortless bearing dismounting up to 100 kN

Hydraulic jaw puller kit TMHP 10E

- A versatile kit with three different arm lengths is suitable for a wide range of applications
- Hydraulic spindle facilitates effortless dismounting
- Self-locking arms minimise the risk of the puller slipping from the application when under load
- The spring-loaded centre point of the hydraulic spindle allows easy puller centring
- The hydraulic spindle is equipped with a safety valve, which minimises the risk of puller overload
- High load rating of 100 kN (11.2 US ton) makes the puller suitable for a variety of dismounting jobs
- A hydraulic spindle stroke of 80 mm (3.1 in.) helps facilitate dismounting in one operation
- Supplied with hydraulic spindle extension pieces to allow quick adaptation to pulling length



Technical data

Designation	TMHP 10E		
Contents	1 × arm–assembly stand 3 × arms, 115 mm (4.5 in.) 3 × arms, 160 mm (6.3 in.) 3 × arms, 200 mm (7.9 in.) 1 × hydraulic spindle TMHS 100 3 × extension pieces for hydraulic spindle; 50, 100, 150 mm (2, 4, 6 in.) 1 × nosepiece with centre point for hydraulic spindle	Maximum stroke Threading hydraulic cylinder Nominal working force Carrying case dimensions Weight	80 mm (3.1 in.) 1 1/2"-16 UN 100 kN (11.2 US ton) 578 × 410 × 70 mm (23 × 16 × 2.8 in.) 14,5 kg (32 lb)

Mechanical tools

Strong Back Pullers

Selection chart

Designation	Shaft diameter		Maximum bearing outer diameter		Maximum reach	
	mm	in.	mm	in.	mm	in.
TMBS 50E	7–50	0.3–1.9	85	3.3	110	4.3
TMBS 100E	20–100	0.8–3.9	160	6.3	120–816	4.7–32.1
TMBS 150E	35–150	1.4–5.9	215	8.5	120–816	4.7–32.1
TMHC 110E	20–100	0.8–3.9	160	6.3	120–245	4.7–9.6



Powerful combination of a jaw and strong back puller

Hydraulic puller kit TMHC 110E

- SKF TMHC 110E hydraulic puller kit combines a jaw puller and a strong back puller
- A versatile puller kit facilitates safe and easy dismantling in a variety of applications
- Hydraulic spindle facilitates easy and quick dismantling
- High load rating of 100 kN (11.2 US ton)
- The strong back puller includes two different arm lengths for maximum reach of 120 mm (4.7 in.)
- The jaw puller can be assembled as a three-arm or two-arm puller depending on the space and demands of the application
- The firm grip of the strong back puller behind the bearing's inner ring reduces the force required to dismount the bearing
- Supplied with extension rods to allow quick adaptation to pulling lengths up to 245 mm (9.6 in.)
- The spring-loaded centre point of the hydraulic spindle allows easy puller centring minimizing the risk of shaft damage



Technical data

Designation	TMHC 110E		
Contents	1 × arm-assembly stand 3 × arms, 65 mm (2.6 in.) 3 × arms, 115 mm (4.5 in.) 1 × separator set 1 × beam 2 × main rods 2 × extension rods, 125 mm (4.9 in.) 1 × hydraulic spindle TMHS 100 2 × extension pieces for hydraulic spindle; 50, 100 mm (2.0, 3.9 in.) 1 × nosepiece with centre point for hydraulic spindle	Arms set 1 (3 ×) Effective arms length Width of grip Claw height	65 mm (2.5 in.) 50–110 mm (2–4.3 in.) 8 mm (0.3 in.)
		Arms set 2 (3 ×) Effective arms length Width of grip Claw height	115 mm (4.5 in.) 75–170 mm (2.9–6.7 in.) 8 mm (0.3 in.)
		Strong back puller Maximum reach Shaft diameter range	250 mm (9.8 in.) 20–100 mm (0.8–3.9 in.)
Maximum stroke	80 mm (3.1 in.)		
Nominal working force	100 kN (11.2 US ton)		
Threading hydraulic cylinder	1 1/2"-16 UN		
Carrying case dimensions	580 × 410 × 70 mm (23 × 16 × 2.8 in.)		
Weight	13.5 kg (29.8 lb)		

Easy bearing dismounting even in the tightest spaces

Strong back pullers TMBS E series

The SKF TMBS E strong back pullers facilitate dismounting of bearings in applications where the use of traditional jaw pullers is restricted due to lack of space or where the application demands a long reach.

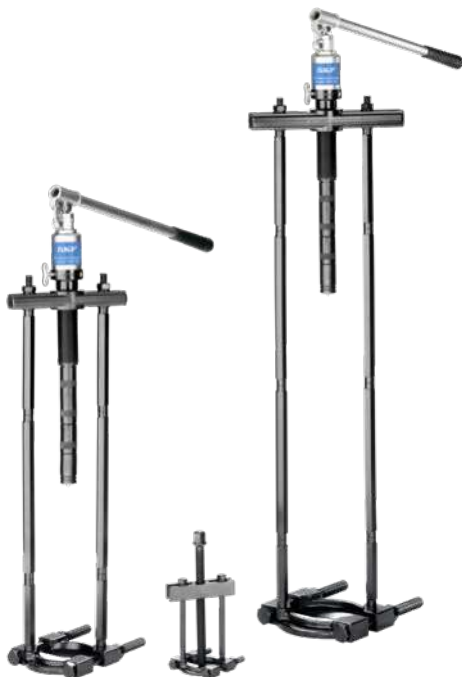

- Special separator design allows the puller to be easily inserted between the bearing and the shoulder on the shaft
- The spring-loaded centre point of the hydraulic spindle allows easy puller centring minimizing the risk of shaft damage
- The firm grip behind the bearing's inner ring reduces the force required to dismount the bearing
- The hydraulic spindle is equipped with a safety valve, which minimises the risk of puller overload
- A hydraulic spindle stroke of 80 mm (3.1 in.) helps facilitate dismounting in one operation
- SKF TMBS 50E is equipped with a mechanical spindle for force generation
- SKF TMBS 100E and the SKF TMBS 150E are equipped with a hydraulic spindle, which allows for easy application of force up to 100 kN (11.2 US ton)
- Supplied with hydraulic spindle extension pieces to allow quick adaptation to pulling length
- SKF TMBS 100E and SKF TMBS 150E are supplied with extension rods to allow quick adaptation to pulling lengths upto 816 mm (32.1 in.)



Technical data

Designation	TMBS 50E	TMBS 100E	TMBS 150E
Contents	1 × separator set 1 × mechanical spindle 1 × beam 2 × main rods	1 × separator set 2 × main rods 2 × extension rods, 125 mm (4.9 in.) 4 × extension rods, 285 mm (11.2 in.) 1 × beam 1 × hydraulic spindle TMHS 100 2 × extension pieces for hydraulic spindle; 50, 100 mm (2.0, 3.9 in.) 1 × nosepiece with centre point for hydraulic spindle	1 × separator set 2 × main rods 2 × extension rods, 125 mm (4.9 in.) 4 × extension rods, 285 mm (11.2 in.) 1 × beam 1 × hydraulic spindle TMHS 100 2 × extension pieces for hydraulic spindle; 50, 100 mm (2.0, 3.9 in.) 1 × nosepiece with centre point for hydraulic spindle
Maximum stroke	–	80 mm (3.1 in.)	80 mm (3.1 in.)
Nominal working force	30 kN (3.4 US ton)	100 kN (11.2 US ton)	100 kN (11.2 US ton)
Maximum reach	110 mm (4.3 in.)	120–816 mm (4.7–32.1 in.)	120–816 mm (4.7–32.1 in.)
Shaft diameter range	7–50 mm (0.3–2 in.)	20–100 mm (0.8–3.9 in.)	35–150 mm (1.4–5.9 in.)
Threading hydraulic cylinder	–	1 1/2"-16 UN	1 1/2"-16 UN
Carrying case dimensions	295 × 190 × 50 mm (11.6 × 7.5 × 2 in.)	580 × 410 × 70 mm (23 × 16 × 2.8 in.)	580 × 410 × 70 mm (23 × 16 × 2.8 in.)
Weight	1.8 kg (4 lb)	13.5 kg (29.8 lb)	17 kg (37.5 lb)

Mechanical tools

Blind housing pullers

The SKF Deep Groove Ball Bearing Puller Kit TMMD 100 allows quick and easy dismantling of SKF Deep Groove Ball Bearings with an interference fit on both rings.

The SKF Blind Housing Puller Kit TMBP 20E is an adapter type puller for dismantling deep groove ball bearings in blind housings with shaft dimensions between 30 mm and 160 mm (1.18–6.3 in.). The use of extension rods allows a long reach of up to 547 mm (21.5 in.).

Selection chart

Designation	Bearing bore diameter (d)	Effective arm length
TMBP 20E	30–160 mm (1.2–6.3 in.)	547 mm (21.5 in.)
TMMD 100	10–100 mm (0.4–3.9 in.)	135–170 mm (5.3–6.7 in.)



Removes bearing without dismantling machinery

Blind housing puller Kit TMBP 20E

- Allows a wide range of deep groove ball bearings to be dismantled
- Ball adapters designed for a long service life
- Extension rods allow a reach of up to 583 mm (23 in.)
- Spanner stop function on spindle for easy and safe handling
- Self-locking nose piece helps minimise damage to shaft, and improves puller stability
- Supplied in a sturdy carrying case

Suitability chart

SKF TMBP 20E is suitable for dismantling the following deep groove ball bearings

60.. series	62.. series	63.. series	64.. series	16... series
6021–6032	6213–6230	6309–6320	6406–6418	16026–16032

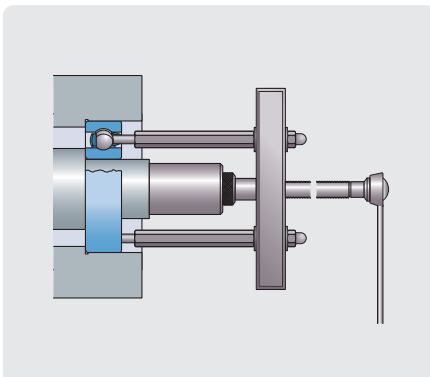

Technical data

Designation	TMBP 20E
Kit contents	6 adapters sizes (2 pcs each), 2 main rods (with nut support rings and nuts) 4 extension rods, Spindle, Spindle nose piece, Beam
Effective arm length	147–547 mm (5.8–21.5 in.)
Maximum pulling force	55 kN (6.2 US ton)
Carrying case dimensions	530 × 85 × 180 mm (20.9 × 3.4 × 7.0 in.)
Weight	6.5 kg (14.3 lb)





Optimised puller claw design firmly grips the outer raceway of SKF bearings, without the need of removing the bearing cage.



The rubber cap allows easy and quick attachment of the arms to the spindle. It also prevents the puller arms from detaching from the spindle during operation

Easy dismounting of bearings in blind housings

Deep groove ball bearing puller kit TMMD 100

The puller is suitable for use in both blind housings and shaft applications. The SKF TMMD 100 is suitable for dismounting up to 71 different SKF deep groove ball bearings, with shaft diameters ranging between 10 and 100 mm (0.4–3.9 in.).

- The claws are designed to precisely fit in the bearing's raceway, providing a good grip, thereby allowing high dismounting forces
- Each puller arm is fitted with a spring for easy installation
- The claw has been designed to allow easy insertion
- The hexagon head of the spindle is designed to prevent the spanner sliding down the spindle during dismounting
- The puller can also be used to remove sealed bearings from blind housings, after the seal has been removed
- Supplied in a sturdy carrying case

Suitability chart

The SKF TMMD 100 suits the following bearing series and sizes:

Bearing designation	Shaft diameter	
6000–6020	10–100 mm	(0.4–3.9 in.)
6200–6218	10–90 mm	(0.4–3.5 in.)
6300–6313	10–65 mm	(0.4–2.6 in.)
6403–6410	17–50 mm	(0.7–2.0 in.)
62/22, 62/28, 63/22, 63/28	22, 28, 22, 28 mm	(0.9, 1.1, 0.9, 1.1 in.)
16002, 16003, 16011	15, 17, 55 mm	(0.6, 0.7, 2.2 in.)
16100, 16101	10, 12 mm	(0.4, 0.5 in.)

Technical data

Designation	TMMD 100
Kit contents	3 × puller arm A1 3 × puller arm A2 3 × puller arm A3 3 × puller arm A4 3 × puller arm A5 3 × puller arm A6 2 × spindle and nut, 1 × handle
Effective arm length	135–170 mm (5.3–5.7 in.)
Carrying case dimensions	530 × 85 × 180 mm (20.9 × 3.4 × 7.0 in.)
Weight	3.6 kg (7.9 lb)



Mechanical tools

Internal pullers

The SKF Internal Bearing Puller Kits are designed for dismounting bearings from housings, where the fit is on the outer ring. The pullers are constructed for optimum strength and durability and suit a wide range of bearing bore diameters. A sliding hammer allows high impact forces to be applied and is ergonomically designed to enhance user safety.

Fast and easy bearing dismounting from housings

Internal bearing puller kits TMIP and TMIC series



TMIP series

- Unique SKF design can reduce dismounting time
- Unlike most internal bearing pullers, the spring loaded extractors can be quickly and easily fitted to the inner ring in just one quick action
- Claw design provides a strong and secure grip behind the inner ring allowing a high puller force to be applied
- Three different kits to suit bearing bores between 7 – 28 mm, 30 – 60 mm and 7 – 60 mm





TMIC series

- Expandable collet design made of high strength materials
- Designed for applications with only a limited space to grip behind the bearing
- Suit bearing bores between 7 – 28 mm

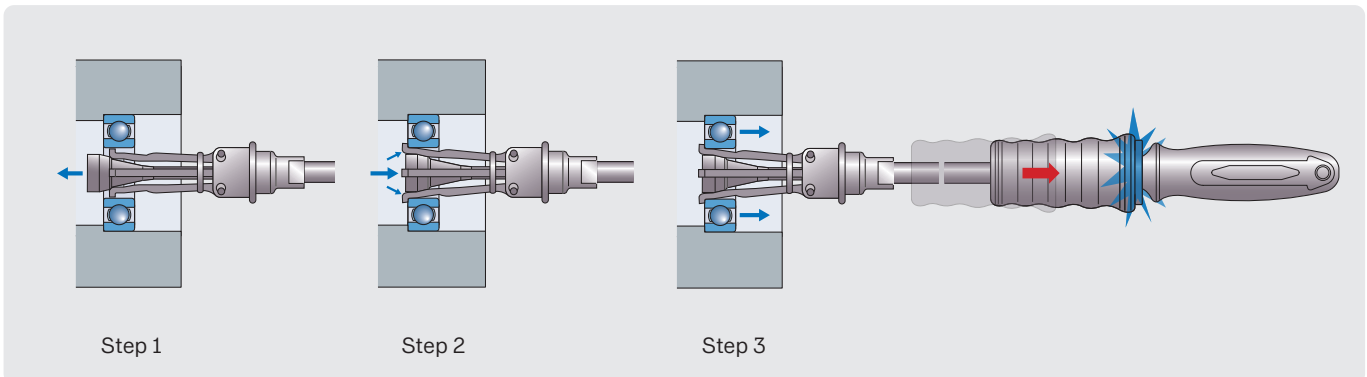
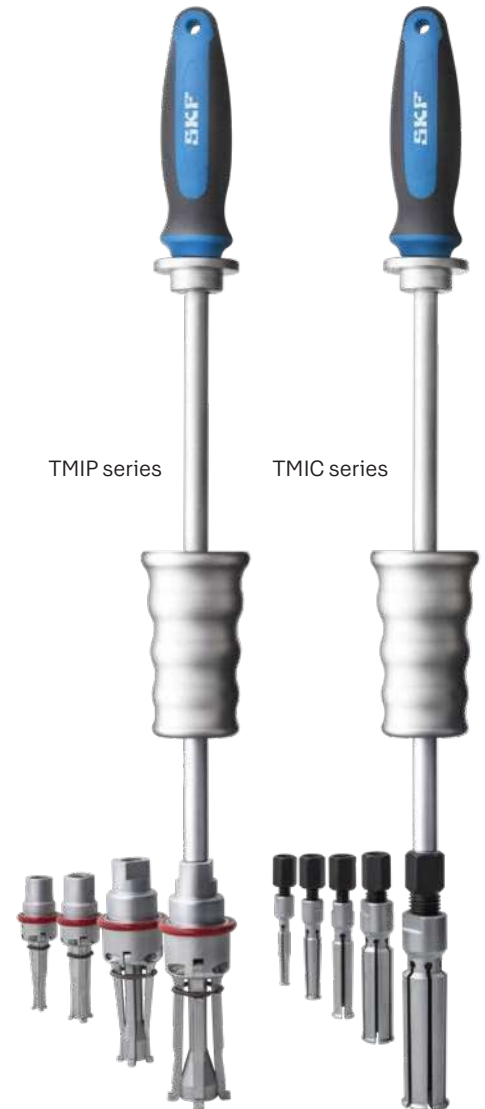
Supplied in a sturdy carrying case



Selection chart

Extractor	Bearing bore diameter	Bearing DGBB				
			SABB	ACBB	SRB	
TMIC C7-8	7–8 mm	607–638, 618/7–638/8		127–108	–	–
TMIC C10-12	10–12 mm	6000–6301, 16000–16101, 61800–61801		1200–2301	3200–5201	–
TMIC C12-15	12–15 mm	6001–6302, 16101–16902, 61801–61902		1201–2301	3201–3202	–
TMIC C17-20	17–20 mm	6003–6404, 16003–16004, 61803–61904		1203–2304	3203–3204	22205/20
TMIC C22-28	22–28 mm	6005–6405, 16005, 61805–62205, 62/22–63/28		1205–2305	3205–3305	22205–21305
TMIP E7-9	7–9 mm	607–629, 618/7–619/9, 627–628/8		127–129	–	–
TMIP E10-12	10–12 mm	6000–6301, 16000–16101, 61800–61801		1200–2301	3200–5201	–
TMIP E15-17	15–17 mm	6002–6403, 16002–16003, 61802–61903		1202–2303	3202–3303	–
TMIP E20-28	20–28 mm	6004–6405, 16004–16005, 62/22–63/28		1204–2305	3204–3305	22205/20–21305
TMIP E30-40	30–40 mm	6006–6408, 16006–16008, 61806–61908		1206–2308	3206–5408	22206–22308
TMIP E45-60	45–60 mm	6009–6412, 16009–16012, 61809–61912		1209–1412	3209–5412	22209–22312

The above tables only show a selection of popular bearings that can be dismounted using SKF Internal Pullers. There may be other bearings that can also be removed using the SKF TMIP or TMIC pullers.



Technical data – extractors

Designation	Maximum bearing width		Space behind bearing		Housing depth		
	mm	in.	mm	in.	mm	in.	
TMIC 7-28	TMIC C7-8	13.3	0.5	3	0.12	54	2.1
	TMIC C10-12	46.5	1.8	3	0.12	56	2.2
	TMIC C12-15	54	2.1	4	0.16	62	2.4
	TMIC C17-20	59	2.3	5.3	0.21	70	2.8
	TMIC C22-28	90	3.5	6.7	0.26	90	3.5
TMIP 7-28	TMIP E7-9	10	0.4	6	0.24	39	1.5
	TMIP E10-12	11	0.4	6	0.24	45	1.8
	TMIP E15-17	18	0.7	7.5	0.29	55	2.2
	TMIP E20-28	24	0.9	10	0.4	60	2.4
TMIP 30-60	TMIP E30-40	>35	>1.4	11.5	0.45	97	3.8
	TMIP E45-60	>64	>2.5	15	0.6	102	4.0
TMIP 7-60	TMIP E7-9	10	0.4	6	0.24	39	1.5
	TMIP E10-12	11	0.4	6	0.24	45	1.8
	TMIP E15-17	18	0.7	7.5	0.29	55	2.2
	TMIP E20-28	24	0.9	10	0.4	60	2.4
	TMIP E30-40	>35	>1.4	11.5	0.45	97	3.8
	TMIP E45-60	>64	>2.5	15	0.6	102	4.0



Technical data

Designation	TMIC 7-28	TMIP 7-28	TMIP 7-60	TMIP 30-60
Bearing bore diameter	7–28 mm (0.28–1.1 in.)	7–28 mm (0.28–1.1 in.)	7–60 mm (0.28–2.4 in.)	30–60 mm (1.2–2.4 in.)
Total sliding hammer length	417 mm (16.4 in.)	417 mm (16.4 in.)	417 mm (16.4 in.) and 557 mm (21.9 in.)	557 mm (21.9 in.)
Carrying case dimensions	530 × 85 × 180 mm (20.9 × 3.4 × 7.0 in.)	530 × 85 × 180 mm (20.9 × 3.4 × 7.0 in.)	530 × 110 × 360 mm (20.9 × 4.3 × 14.2 in.)	530 × 85 × 180 mm (20.9 × 3.4 × 7.0 in.)
Weight	3.0 kg (6.6 lb)	3.1 kg (6.8 lb)	9.4 kg (20.9 lb)	5.4 kg (11.9 lb)

Mechanical tools

Accessories

A range of accessories has been developed to further facilitate the ease of use of the SKF puller range.

Puller series

Standard jaw pullers



Heavy duty jaw pullers



TMMP series
Standard jaw pullers

TMMP series
Heavy duty jaw pullers

i 24



TMMR F series
Reversible jaw pullers

i 26



TMMA series
SKF EasyPull

i 22



TMHC 110E
Hydraulic Puller kit

TMHP 10E
Hydraulic Puller kit

i 27, 28



TMBS E series
Strong back pullers

i 25

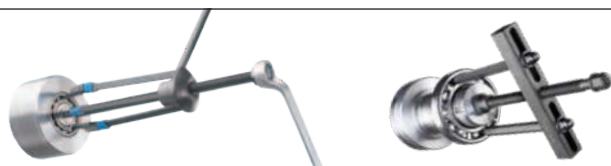

TMMD 100/TMBP 20E
Blind housing puller kits

i 30, 31



i 38

Puller Protection Blankets
TMMX series



i 36

Force Generators Advanced
Hydraulic Spindle TMHS series



i 37

Tri-section Pulling Plates
TMMS series

Designation

TMMP 2x65	TMMX 210 ¹⁾						
TMMP 2x170	TMMX 210	TMMX 280					
TMMP 3x185	TMMX 210 ¹⁾						
TMMP 3x230	TMMX 210	TMMX 280 ¹⁾				TMMS 50 ¹⁾	TMMS 100
TMMP 3x300	TMMX 280	TMMX 350 ¹⁾				TMMS 50 ¹⁾	TMMS 100
						TMMS 50	TMMS 100 ¹⁾ TMMS 160
TMMP 6	TMMX 210					TMMS 50 ¹⁾	
TMMP 10	TMMX 280	TMMX 350				TMMS 100 ¹⁾	
TMMP 15	–	TMMX 350				TMMS 100 ¹⁾	TMMS 160 ¹⁾
TMMP 2x65							
TMMP 2x170							
TMMP 3x185							
TMMP 3x230							
TMMP 3x300							
TMMP 6							
TMMP 10							
TMMP 15							
TMMP 2x65							
TMMP 2x170							
TMMP 3x185							
TMMP 3x230							
TMMP 3x300							
TMMP 6							
TMMP 10							
TMMP 15							
TMMP 2x65							
TMMP 2x170							
TMMP 3x185							
TMMP 3x230							
TMMP 3x300							
TMMP 6							
TMMP 10							
TMMP 15							
TMMP 2x65							
TMMP 2x170							
TMMP 3x185							
TMMP 3x230							
TMMP 3x300							
TMMP 6							
TMMP 10							
TMMP 15							
TMMP 2x65							
TMMP 2x170							
TMMP 3x185							
TMMP 3x230							
TMMP 3x300							
TMMP 6							
TMMP 10							
TMMP 15							
TMMP 2x65							
TMMP 2x170							
TMMP 3x185							
TMMP 3x230							
TMMP 3x300							
TMMP 6							
TMMP 10							
TMMP 15							
TMMP 2x65							
TMMP 2x170							
TMMP 3x185							
TMMP 3x230							
TMMP 3x300							
TMMP 6							
TMMP 10							
TMMP 15							
TMMP 2x65							
TMMP 2x170							
TMMP 3x185							
TMMP 3x230							
TMMP 3x300							
TMMP 6							
TMMP 10							
TMMP 15							
TMMP 2x65							
TMMP 2x170							
TMMP 3x185							
TMMP 3x230							
TMMP 3x300							
TMMP 6							
TMMP 10							
TMMP 15							
TMMP 2x65							
TMMP 2x170							
TMMP 3x185							
TMMP 3x230							
TMMP 3x300							
TMMP 6							
TMMP 10							
TMMP 15							
TMMP 2x65							
TMMP 2x170							
TMMP 3x185							
TMMP 3x230							
TMMP 3x300							
TMMP 6							
TMMP 10							
TMMP 15							
TMMP 2x65							
TMMP 2x170							
TMMP 3x185							
TMMP 3x230							
TMMP 3x300							
TMMP 6							
TMMP 10							
TMMP 15							
TMMP 2x65							
TMMP 2x170							
TMMP 3x185							
TMMP 3x230							
TMMP 3x300							
TMMP 6							
TMMP 10							
TMMP 15							
TMMP 2x65							
TMMP 2x170							
TMMP 3x185							
TMMP 3x230							
TMMP 3x300							
TMMP 6							
TMMP 10							
TMMP 15							
TMMP 2x65							
TMMP 2x170							
TMMP 3x185							
TMMP 3x230							
TMMP 3x300							
TMMP 6							
TMMP 10							
TMMP 15							
TMMP 2x65							
TMMP 2x170							
TMMP 3x185							
TMMP 3x230							
TMMP 3x300							
TMMP 6							
TMMP 10							
TMMP 15							
TMMP 2x65							
TMMP 2x170							
TMMP 3x185							
TMMP 3x230							
TMMP 3x300							
TMMP 6							
TMMP 10							
TMMP 15							
TMMP 2x65							
TMMP 2x170							
TMMP 3x185							
TMMP 3x230							
TMMP 3x300							
TMMP 6							
TMMP 10							
TMMP 15							
TMMP 2x65							
TMMP 2x170							
TMMP 3x185							
TMMP 3x230							
TMMP 3x300							
TMMP 6							
TMMP 10							
TMMP 15							
TMMP 2x65							
TMMP 2x170							
TMMP 3x185							
TMMP 3x230							
TMMP 3x300							
TMMP 6							
TMMP 10							
TMMP 15							
TMMP 2x65							
TMMP 2x170							
TMMP 3x185							
TMMP 3x230							
TMMP 3x300							
TMMP 6							
TMMP 10							
TMMP 15							
TMMP 2x65							
TMMP 2x170							
TMMP 3x185							
TMMP 3x230							
TMMP 3x300							
TMMP 6							
TMMP 10							
TMMP 15							
TMMP 2x65							
TMMP 2x170							
TMMP 3x185							
TMMP 3x230							
TMMP 3x300							
TMMP 6							
TMMP 10							
TMMP 15							
TMMP 2x65							
TMMP 2x170							
TMMP 3x185							
TMMP 3x230							
TMMP 3x300							
TMMP 6							
TMMP 10							
TMMP 15							
TMMP 2x65							
TMMP 2x170							
TMMP 3x185							
TMMP 3x230							
TMMP 3x300							
TMMP 6							
TMMP 10							
TMMP 15							
TMMP 2x65							
TMMP 2x170							
TMMP 3x185							
TMMP 3x230							
TMMP 3x300			</				

Mechanical tools



Effortless withdrawal force generation

Advanced hydraulic spindles TMHS 75 and TMHS 100

The SKF TMHS 75 and TMHS 100 generate a high pulling force with very little effort compared to the standard mechanical spindles. They significantly reduce the time needed to dismount a bearing or other component.

- Integrated hydraulic cylinder, pump and spindle – no separate pump is required
- Safety valve helps prevent overloading the spindle and the puller in case excessive force is applied
- Long stroke helps enable dismounting in one operation
- Spring-loaded nosepiece centre point allows easy puller centring minimising shaft centre point damage
- Hand lever with ergonomic grip can be rotated 360°
- Extension pieces included

TMHS 75:

- Maximum withdrawal force of 75 kN (8.4 US ton)
- Stroke length of 75 mm (3.0 in.)
- Suitable for use with pullers with a 1 1/4"-12 UNF thread

TMHS 100:

- Maximum withdrawal force of 100 kN (11.2 US ton)
- Stroke length of 80 mm (3.1 in.)
- Suitable for use with pullers with a 1 1/2"-16 UN thread

TMHS 100 shown as part of hydraulic puller TMMA 100H

Technical data		
Designation	TMHS 75	TMHS 100
Contents	1 × hydraulic spindle 2 × extension pieces; 50 and 100 mm (2.0 and 3.9 in.) 1 × nosepiece	1 × hydraulic spindle 3 × extension pieces; 50, 100 and 150 mm (2.0, 3.9 and 5.9 in.) 1 × nosepiece
Maximum withdrawal force	75 kN (8.4 US ton)	100 kN (11.2 US ton)
Piston stroke	75 mm (3.0 in.)	80 mm (3.1 in.)
Body thread	1 1/4"-12 UNF	1 1/2"-16 UN
Nose piece diameter	35 mm (1.4 in.)	30 mm (1.2 in.)
Maximum reach	229 mm (9.0 in.)	390 mm (15.4 in.)
Weight	2.7 kg (6.0 lb)	4.5 kg (10.0 lb)



Efficient and correct dismounting

Tri-section pulling plates TMMS series

- The SKF TMMS series consists of five different sizes of tri-section pulling plates suitable for shafts with diameters ranging from 50 to 380 mm (2 to 15 in.)
- Suitable for use in combination with three-armed pullers
- The plates grip behind the bearing inner ring, helping to ensure that the pulling forces are only transmitted through the inner ring and not through the outer ring or the rolling elements; thereby minimising the risk of bearing damage
- The tri-section construction allows an even dismounting force distribution, preventing bearing locking and/or tilting on the shaft, especially in the case of spherical roller and CARB toroidal roller bearings
- Special wedge shape design allows the plates to be easily inserted between the bearing and the shoulder on the shaft

Dimensions

Designation	d _{min}		d _{max}		A		H	
	mm	in.	mm	in.	mm	in.	mm	in.
TMMS 50	12	0.5	50	2.0	20–30	0.8–1.2	15	0.6
TMMS 100	26	1.0	100	3.9	36–55	1.4–2.1	25	1.0
TMMS 160	50	2.0	160	6.3	45–73	1.8–2.9	30	1.2
TMMS 260	90	3.6	260	10.2	70–114	2.8–4.5	42	1.7
TMMS 380	140	5.5	380	15.0	81–142	3.2–5.6	58	2.3

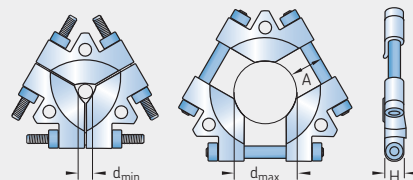

TMMS 160 shown as part of hydraulic puller set TMMA 100H/SET

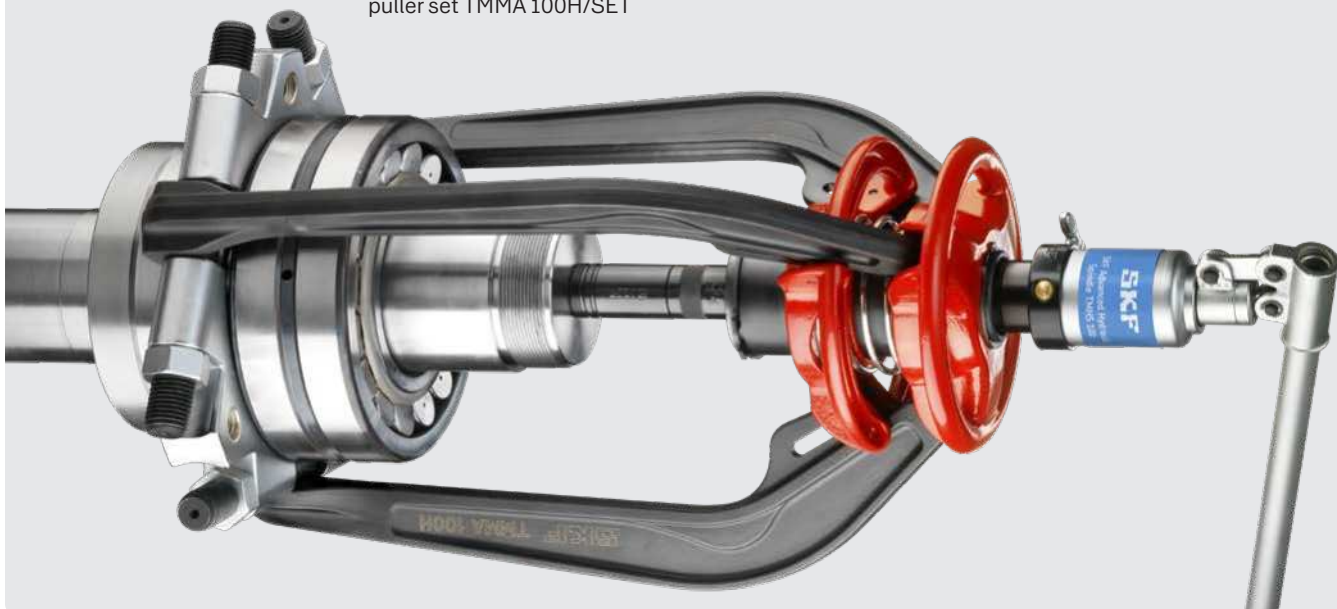

Mechanical tools



For additional user safety during dismantling

Puller protection blankets TMMX series

- The SKF TMMX series are designed to offer additional user safety, while dismantling bearings or other components
- After the puller has been positioned, the blanket is simply wrapped around the puller and application
- The tough, transparent plastic allows the user to monitor the component and the puller during operation
- Especially designed to fit SKF TMMX series pullers, they are also suitable for use in combination with many other pullers

Dimensions

Designation	Recommended maximum diameter		Length		Width	
	mm	in.	mm	in.	mm	in.
TMMX 210	210	8.3	750	29.5	320	12.6
TMMX 280	280	11.0	980	38.6	380	15
TMMX 350	350	13.8	1200	47.2	480	18.9

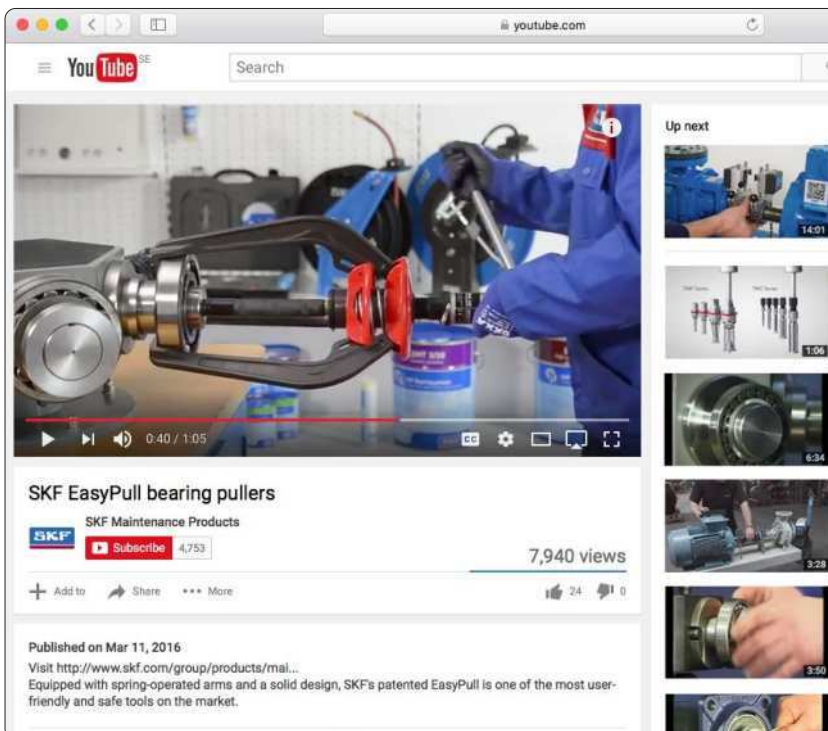

YouTube channel

SKF has a large number of informative videos available on YouTube. There you can find videos that introduce you to new products and give you instruction on how to use the products. In addition, a comprehensive series of videos explains the right techniques for mounting and dismantling bearings of various types. The videos are available with narration or subtitles in various languages. The YouTube channel is an easy way to learn more about SKF maintenance and lubrication products. Just visit and subscribe to be automatically informed when new videos are added.



<https://www.youtube.com/user/MaProNL>

Anti-fretting agent LGAF 3E

SKF LGAF 3E is a greasy, smooth paste to prevent fretting corrosion caused by very slight oscillations or by vibrations, that can make dismantling much more difficult.



- Suitable for bearings and metal surfaces in loose fit arrangements, such as vibrating screens, truck and car wheel bearings
- Reduces fretting corrosion thereby enabling easier dismantling of bearings
- Assists with easier removal of general industrial components in a wide range of applications such as nuts, bolts, flanges, studs, bearings, guide pins, couplings, jack screws, lathe centres, push rods, and spline shafts

Available pack sizes

Packsize	Designation
35 g tube	LGAF 3E/0.035
0,5 kg can	LGAF 3E/0.5
30 kg drum	LGAF 3E/30

Technical data

Designation	LGAF 3E
Specific gravity	1.19
Colour	Beige
Base oil type	Mineral and synthetic
Thickener	Lithium soap
Operating temperature range	-25 to +250 °C (-13 to +482 °F)
Base oil viscosity: 40 °C, mm ² /s	195
Shelf life	5 years

These characteristics represent typical values.

What is fretting corrosion?

Fretting corrosion is a progressive surface damage that occurs in the contact area of two metals. It is caused by very slight oscillations, vibrations or slip between the metal surfaces. Fretting corrosion is a risk for bearings and it typically occurs in the loose fit between the outer ring and the housing or between the inner ring and shaft. Uneven bearing seats and too loose fits can increase fretting corrosion. Repairing corrosion damages requires overhauling of the contact area and poses further risks of improper bearing seating. Fretting corrosion is also a risk for other metal contact areas for example yokes and core of SKF Induction Heaters and SKF Vibracon.

SKF LGAF 3E is a greasy, smooth paste with special additives to form a protective layer between the metal surfaces and reduce fretting corrosion in these and more applications.

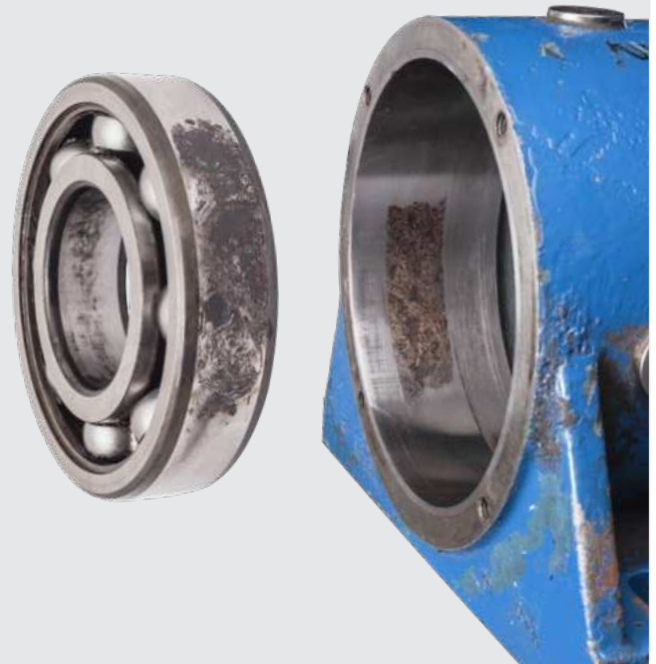

Heating tools

It's a fact.

Incorrect mounting methods account for up to 16% of premature bearing failures

Main causes of premature bearing failures

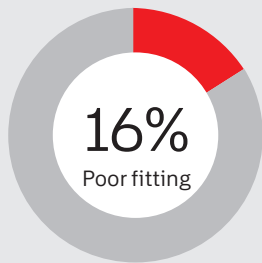

To reduce the risk of incorrect mounting, SKF helped pioneer the use of portable induction heaters for bearing mounting applications in the 1970's. Since that time, there have been many advances in technology and SKF has been at the forefront in developing safer, more efficient and user-friendly bearing induction heaters.

SKF Induction Heaters utilise advanced power electronics with application specific designs for high performance.

As a result, by using an SKF induction heater, the total cost of ownership is often significantly lower. Ergonomics and safety are also an important consideration for operators. SKF induction heaters are equipped with design features that make them easy to use and safe. Bearing support arms reduce the risk of the bearing toppling during heating, and ergonomically designed yokes help reduce operator fatigue. In addition, the unique remote control enables the operator to control the heater at a safe distance from the hot bearing, enhancing operator safety.

Induction heating has many advantages over other bearing heating methods

The use of an open flame to heat a bearing is not only inefficient and uncontrolled, but often leads to bearing damage. This method should not be used.

Oil baths are sometimes used to heat bearings. Oil baths often take a long time to reach the required temperature and can be difficult to control the actual bearing temperature. The energy consumption of an oil bath is also significantly greater than using an induction heater. The risk of contaminating the bearing due to dirty oil is significant and can lead to premature bearing failure. Handling hot, oily and slippery bearings present significant hazards to the operator and great care must be taken to avoid potential injuries.

Ovens and hot plates are often used for batch heating of small bearings and this is an acceptable technique. However, for larger bearings, the use of ovens and hotplates is generally quite inefficient and time consuming and can present the operator with significant handling hazards.

Induction heaters are the modern, efficient and safe way to heat bearings. In operation, they are generally faster, cleaner, more controllable, and easier to use than other heating methods.

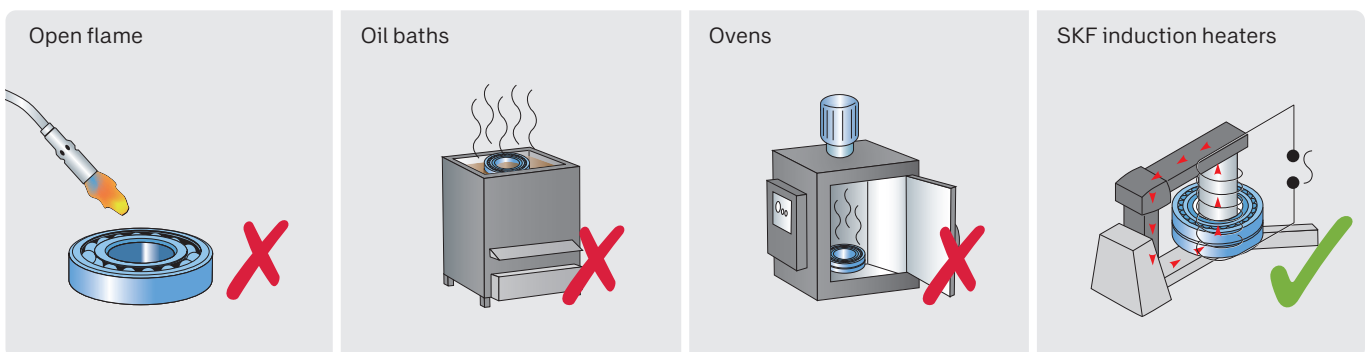



Thermostat controlled bearing heating

Electric hot plate 729659 C

The SKF 729659 C is a heating device especially designed for pre-heating batches of small bearings prior to mounting. The temperature of the plate can be adjusted to provide temperatures between 50 and 200 °C (120 and 390 °F). The flat heating surface ensures even bearing heating and the cover helps retain heat and keep contaminants out.

Technical data

Designation	729659 C 729659 C/110V			
Voltage	729659 C	230 V (50/60 Hz)		
	729659 C/110 V	120 V (50/60 Hz)		
Power	1 000 W		Height of cover	50 mm (2 in.)
Temperature range	50–200 °C (120–390 °F)		Overall dimensions (l × w × h)	390 × 190 × 139 mm (15.4 × 7.5 × 5.5 in.)
Plate dimensions (l × w)	378 × 178 mm (14.8 × 7 in.)		Weight	6 kg (13.2 lb)

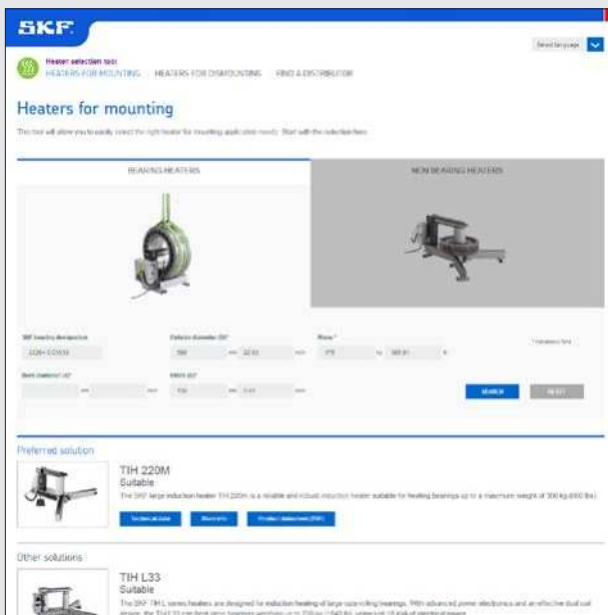

heaterselector.skf.com

Heater selection tool

The online heater selection tool helps to select the most appropriate SKF heater for a given hot mounting or dismantling application of bearings or annular workpieces.

In just three easy steps, you can define your heating application and receive a list of all suitable heaters for that application, including a recommendation of the heater that offers the best price-performance ratio.

The online heater selection tool is available free of charge, just scan the QR code or visit us on skf.com/heaterselector.

The heater selection tool supports all mounting and fixed size EAZ dismantling heaters and offers additional information such as the product data sheet, technical data and product websites for each heater. If you cannot find the right heater for your application or you need more information, please don't hesitate to contact SKF.

The online heater selection tool is available in 8 languages: English, French, German, Spanish, Italian, Portuguese, Russian and Chinese.

Heating tools

A light and compact solution for bearing heating

Compact portable induction heater TMBH 5

The Portable induction heater TMBH 5 is designed for use in maintenance, to heat roller bearings that are mounted onto a shaft with an interference fit. Heat causes the bearing to expand, which removes the need to use force during installation. The TMBH 5 generates a temperature difference between bearing and shaft – enough to enable installation. It can also be used to heat other ring-shaped, metallic components. A reduced power setting allows sensitive components to be heated more slowly.

The TMBH 5 relies on an induction clamp that contains internal coils. A current in the coils generates a fluctuating magnetic field. This induces currents within the component, which are converted to heat. Because this heat is generated within the component – and not the clamp – the process is highly energy-efficient.

The unit's LED interface is intuitive to use, allowing the user to select either Temperature Mode or Time Mode. An LED indicates when the TMBH 5 is in operation – as it hardly makes any noise.

- Highly portable, compact and light in weight
- Automatic temperature monitoring
- No need to choose separate yoke for each component
- Use of advanced medium frequency electronics
- Choice of power settings
- User-friendly control panel
- Silent operation



Accessories fit into convenient side compartments



Technical data

Designation TMBH 5/230V, TMBH 5/120V

Application ¹⁾

Bearing weight range ²⁾ up to 5 kg (11 lb)

Min. bearing bore diameter 20 mm (0.8 in.)

Max. bearing outer diameter 100 mm (4 in.)

Max. bearing width 50 mm (2 in.)

Operating space heating clamp 50 x 50 mm (2 x 2 in.)

Maximum power TMBH 5/230V: 350 W
TMBH 5/120V: 350 W

Voltage and frequency TMBH 5/230V: 230 V ±10%, 50/60Hz
TMBH 5/120V: 120 V ±10%, 50/60Hz

Max. current consumption

TMBH 5/230V: 2 A
TMBH 5/120V: 4 A

Temperature control

40-200 °C (104-392 °F)

Time control

5 seconds – 60 minutes

Demagnetisation

The heater does not magnetise

Dimensions (w x d x h)

275 x 180 x 270 mm (10.8 x 7.09 x 10.6 in.)

Total weight

3 kg (6.6 lb)

¹⁾ SKF does not recommend heating bearings capped with seals or shields above 80 °C (175 °F). However, if higher temperatures are necessary, please contact SKF. The heater is designed for maintenance operations where some cooling in between jobs is allowed.

²⁾ Depending on the geometry of the bearing, maximum heating temperature.

A portable solution for bearing heating

Portable induction heater TWIM 15

The Portable induction heater TWIM 15 is designed for applications in maintenance jobs to heat up bearings that are mounted with an interference fit onto a shaft. Heating the bearing causes it to expand, which eliminates the need to use force during installation. Generally, using the TWIM 15 to generate a 90 °C (162 °F) temperature difference between the bearing and shaft is sufficient to enable installation. In addition, the TWIM 15 can be used to heat other ring-shaped, metallic components, providing flexibility of use.

Utilizing electrical power, the TWIM 15 features glass-fiber, high-temperature-resistant plastic construction that allows a low temperature difference between the inner and outer rings of the bearing. This helps to reduce internal tensions that are generated due to excessive thermal expansion of the inner ring compared to the outer ring.

The unit has a user-friendly LED control panel that requires no special training and is simple to understand. The panel is used to regulate temperature and also indicates that the TWIM 15 is operational.

- Innovative heating of bearings
- Portable, compact and lightweight
- No support yokes required
- Automatic temperature monitoring
- Detects bearing size and heats appropriately
- Different power levels
- User-friendly LED control panel
- Quiet operation
- Optional carrying bag (TWIM 15-BAG)
- The heater and bag can also be ordered as a kit, designation: TWIM 15K



Technical data

Designation	TWIM 15		
Application ¹⁾		Max. current consumption	TWIM 15/230 V: 10 A TWIM 15/110 V: 16 A
Bearing weight range ²⁾	0.5 kg (1.1 lb) - 20 kg (44 lb)	Temperature control	40-200 °C (104-392 °F)
Min. bearing bore diameter	30 mm (1.18 in.)	Demagnetisation	The heater does not magnetise
Max. bearing outer diameter	320 mm (12.6 in.)	Dimensions (w x d x h)	450 x 500 x 100 mm (17.7 x 19.7 x 3.9 in.)
Max. bearing width	85 mm (3.35 in.)	Total weight	6.6 kg (14.6 lb)
Performance examples (bearing, weight, temperature, time)	6320: 7.1 kg (15.7 lb), 110 °C (230 °F), 5 min 20 s 22320 CC/W33: 12.8 kg (28.2 lb), 110 °C (230 °F), 12 min 35 s		
Maximum power	TWIM 15/230 V: 2.3 kVA TWIM 15/110 V: 1.8 kVA		
Voltage and frequency	TWIM 15/230 V: 230 V, ±10%, 50/60 Hz TWIM 15/110 V: 110 V, ±10%, 50/60 Hz		

¹⁾ SKF does not recommend heating bearings capped with seals or shields above 80 °C (175 °F). However, if higher temperatures are necessary, please contact SKF. The heater is designed for maintenance operations where some cooling in between jobs is allowed.

²⁾ Depending on the geometry of the bearing, maximum heating temperature and power availability.

Heating tools

TIH series

Features and benefits

The comprehensive SKF induction heater range can be used for efficiently heating bearings and workpieces, both large and small. Their innovative design offers significant advantages to both owners and operators:

- Advanced power electronics, with accurate electric current control, help control the temperature rate increase
- Two step power setting option (50% / 100%), enables small bearings to be heated safely and at a lower power consumption
- For heating components other than bearings, all heaters are equipped with a heating time mode and for large components, optimized TIH MB heaters for solid workpieces are available
- Thermal overheating protection reduces the risk of damage to the induction coil and electronics, enhancing reliability and safety
- Automatic demagnetisation reduces the risk of ferrous debris contamination after heating
- Available in different voltage variants, to suit most operating voltages worldwide
- Supplied with heat-resistant gloves for improved operator safety

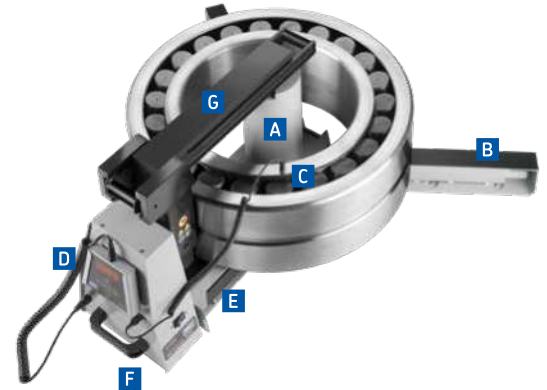

- A** Induction coil located outside the heater's housing enables a shorter heating time and lower energy consumption
- B** Foldable bearing support arms allow larger diameter bearings to be heated, and reduce the risk of the bearing toppling during heating
- C** Magnetic temperature probe, combined with a temperature mode pre-set at 110 °C (230 °F), helps prevent bearing overheating
- D** Unique SKF remote control, with operating display and control panel, makes the heater easy and safe to use
- E** Internal yoke storage, for smaller yoke(s), reduces the risk of yoke damage or loss
- F** Integrated carrying handles allow for easy movement of the heater in the workshop
- G** Sliding or swivel arm allows for easy and quick bearing replacement, reducing operator fatigue (not for TIH 030m)

TIH induction heater range

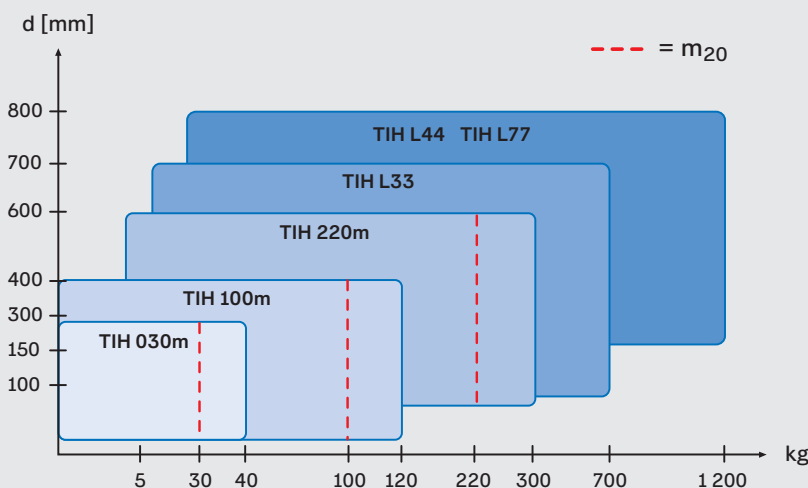

The comprehensive range of SKF induction heaters is suitable for most bearing heating applications. The chart gives general information on choosing an induction heater for bearing heating applications¹⁾.

The SKF m₂₀ concept represents the weight (kg) of the heaviest SKF spherical roller bearing of series 231 which can be heated from 20 to 110 °C (68 to 230 °F) in 20 minutes. This defines the heater's power output instead of its power consumption. Unlike other bearing heaters, there is a clear indication of how long it takes to heat a bearing, rather than just the maximum bearing weight possible.

¹⁾ For heating components other than bearings, SKF recommends consideration of TIH L MB series heater. Contact SKF to help you select a suitable induction heater for your application.



Small induction heater with a 40 kg bearing heating capacity

TIH 030m

- Compact lightweight design; just 21 kg (46 lb), facilitating portability
- Capable of heating a 28 kg (62 lb) bearing in just 20 minutes
- Supplied standard with three yokes, allowing bearings with a bore diameter from 20 mm (0.8 in.) up to a maximum weight of 40 kg (90 lb) to be heated

Medium induction heater with a 120 kg bearing heating capacity

TIH 100m

- Capable of heating a 97 kg (213 lb) bearing in less than 20 minutes
- Supplied standard with three yokes, allowing bearings with a bore diameter from 20 mm (0.8 in.) up to a maximum weight of 120 kg (264 lb) to be heated
- Swivel arm for large size yoke

Large induction heater with a 300 kg bearing heating capacity

TIH 220m

- Capable of heating a 220 kg (480 lb) bearing in just 20 minutes
- Supplied standard with two yokes, allowing bearings with a bore diameter from 60 mm (2.3 in.) up to a maximum weight of 300 kg (660 lb) to be heated
- Sliding arm for large size yoke

Technical data

Designation	TIH 030M	TIH 100M	TIH 220M
Max. bearing weight	40 kg (88 lb)	120 kg (264 lb)	300 kg (662 lb)
Bore diameter range	20–300 mm (0.8–11.8 in.)	20–400 mm (0.8–15.7 in.)	60–600 mm (2.3–23.6 in.)
Operating area (w × h)	100 × 135 mm (3.9 × 5.3 in.)	155 × 205 mm (6.1 × 8 in.)	250 × 255 mm (9.8 × 10 in.)
Coil diameter	95 mm (3.7 in.)	110 mm (4.3 in.)	140 mm (5.5 in.)
Standard yokes (included) to suit bearing/workpiece minimum bore diameter	65 mm (2.6 in.) 40 mm (1.6 in.) 20 mm (0.8 in.)	80 mm (3.1 in.) 40 mm (1.6 in.) 20 mm (0.8 in.)	100 mm (3.9 in.) 60 mm (2.3 in.)
Performance example (bearing, weight, temperature, time)	23136 CC/W33, 28 kg, 110 °C, 20m	23156 CC/W33, 97 kg, 110 °C, 20m	23172 CC/W33, 220 kg, 110 °C, 20m
Max. power consumption	2.0 kVA	TIH 100M/230 V : 3.6 kVA TIH 100M/MV : 4.0–4.6 kVA	TIH 220M/LV: 10.0-12.0 kVA TIH 220M/MV: 10.0-11.5 kVA
Voltage and frequency ¹⁾ 100-120 V, 50/60 Hz 220-240 V, 50/60 Hz 400–460 V, 50/60 Hz	TIH 030M/110 V TIH 030M/230 V –	– TIH 100M/230 V TIH 100M/MV	– TIH 220M/LV TIH 220M/MV
Temperature control ²⁾	20 to 250 °C (68 to 482 °F)	20 to 250 °C (68 to 482 °F)	20 to 250 °C (68 to 482 °F)
Demagnetisation according to SKF norms	<2 A/cm	<2 A/cm	<2 A/cm
Dimensions (w × d × h)	460 × 200 × 260 mm (18.1 × 7.9 × 10.2 in.)	570 × 230 × 350 mm (22.4 × 9 × 13.7 in.)	750 × 290 × 440 mm (29.5 × 11.4 × 17.3 in.)
Total weight (incl. yokes)	20.9 kg (46 lb)	42 kg (92 lb)	86 kg (189 lb)

¹⁾ Some special voltage versions (e.g. 575V, 60 Hz CSA ready) are available for specific countries. For additional information, please contact your local SKF authorised distributor.

²⁾ Maximum heating temperature capacity depends on the weight and geometry of the bearing or workpiece. The heaters can achieve higher temperatures, please contact SKF for advice.

Heating tools

TIH L series

The SKF TIH L series heaters are characterized by a high heating power and large size. They are the continuation of the TIH series for heating large size bearings.

All heaters are equipped with sliding yokes, dual coil design and advanced power electronics. The frame of the heater allows easy transportation by fork lift. The key differences between heaters in the TIH L range are heating power and operating area.



Large induction heater with a 700 kg bearing heating capacity

TIH L33

- Using just 15 kVA of electrical power, the TIH L33 can heat large bearings up to 700 kg (1 543 lb)
- Two optional yokes available for smaller bearing diameters.
- Available in 230 and 400V executions.

Extra-large induction heater with a 1 200 kg bearing heating capacity

TIH L44

- Using 20 kVA of electrical power, the TIH L44 can heat large bearings up to 1 200 kg (2 600 lb)
- One optional yoke available for smaller bearing diameters.
- Available in 230 and 400V executions.

Extra-large induction heater with expanded operating area

TIH L77

- Extra-large induction heater with expanded operating area
- Using 20 kVA of electrical power, the TIH L77 can heat large bearings up to 1 200 kg (2 600 lb)
- Extra-large operating area for special bearing and component sizes

The sliding yoke is a robust mechanism to easily and safely move the yoke. The sliding rails are very durable and prevent the yoke from accidentally falling. The sliding yoke can easily be replaced by a smaller optional yoke.

The dual coil design offers high performance for heating bearings in either the horizontal or vertical orientation and gives you the flexibility to heat the bearing in the same orientation as the shaft for fast and convenient mounting. By utilizing two coils, the heaters allow more homogeneous heating and offer additional safety for the hot mounting of large sized bearings.

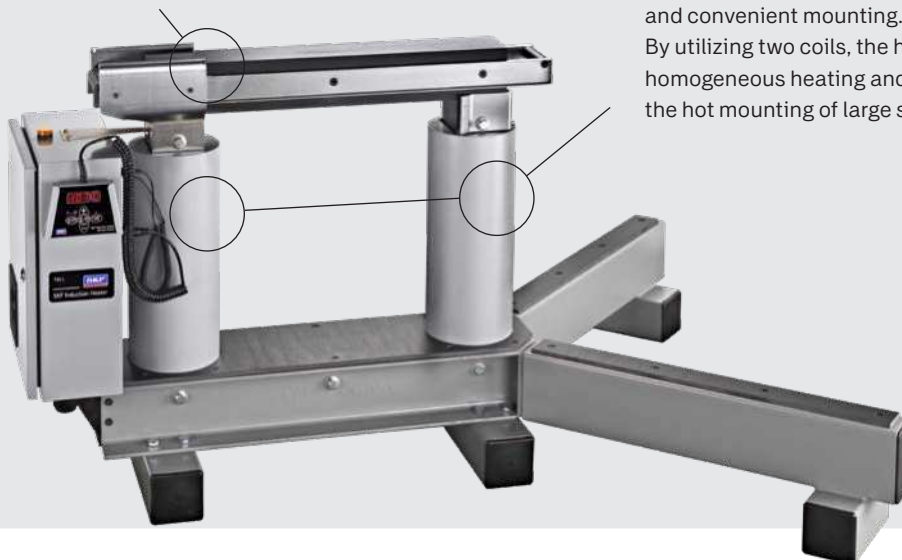

Technical data - TIH L series

Designation	TIH L33	TIH L44	TIH L77
Max. bearing weight	700 kg (1 543 lb)	1 200 kg (2 600 lb)	1 200 kg (2 600 lb)
Bore diameter range	115–700 mm (4.5–27.6 in.)	150–800 mm (5.9–31.5 in.)	150–800 mm (5.9–31.5 in.)
Operating area (w × h)	300 × 320 mm (11.8 × 12.6 in.)	425 × 492 mm (16.7 × 19.4 in.)	725 × 792 mm (28.5 × 31.2 in.)
Coil diameter	150 mm (5.9 in.)	175 mm (6.9 in.)	175 mm (6.9 in.)
Standard yokes (included) to suit bearing minimum bore diameter	115 mm (4.5 in.)	150 mm (5.9 in.)	150 mm (5.9 in.)
Optional yokes to suit bearing minimum bore diameter	80 mm (3.1 in.) 60 mm (2.4 in.)	100 mm (3.9 in.)	–
Performance example (bearing, weight, temperature, time)	24188ECA/W33, 455 kg, 110 °C, 28 min.	24188ECA/W33, 455 kg, 110 °C, 13 min.	–
Max. power consumption	TIH L33/LV: 15 kVA TIH L33/MV: 15 kVA	TIH L44/MV: 20–23 kVA TIH L44/LV: 20–24 kVA	TIH L77/MV: 20–23 kVA TIH L77/LV: 20–24 kVA
Voltage ¹⁾ 200–240 V/50–60 Hz 400–460 V/50–60 Hz	TIH L33/LV TIH L33/MV	TIH L44/LV TIH L44/MV	TIH L77/LV TIH L77/MV
Temperature control ²⁾	0 to 250 °C (32 to 482 °F)	20 to 250 °C (68 to 482 °F)	20 to 250 °C (68 to 482 °F)
Demagnetisation according to SKF norms	<2 A/cm	<2 A/cm	<2 A/cm
Dimensions (w × d × h)	400 × 743 × 550 mm (15.8 × 29.3 × 21.7 in.)	1 200 × 600 × 850 mm (47.3 × 23.6 × 33.5 in.)	1 320 × 600 × 1 150 mm (52 × 23.6 × 45.3 in.)
Total weight (incl. yokes)	140 kg (309 lb)	324 kg (714 lb)	415 kg (915 lb)

¹⁾ Some special voltage versions (e.g. 575 V, 60 Hz CSA ready) are available for specific countries. For additional information, please contact your local SKF authorised distributor.

²⁾ Maximum heating temperature capacity depends on the weight and geometry of the bearing or workpiece. The heaters can achieve higher temperatures, please contact SKF for advice.

The TIH L series of SKF Induction Heaters is designed for fast and safe mounting of large bearings in the workshop or in the field. The heaters offer great versatility and are suitable for a large variety of bearing types and sizes. TIH L series heaters can be found in almost all industries with large sized bearings.



Heating tools

Solid workpiece heaters

The SKF TIH L MB series is specially designed to heat solid workpieces, such as rings, sleeves, gears, couplings, bushings and pulleys, as well as train wheels, tires or similar components. Featuring one magnetic coil in the center, these powerful and durable heaters localize the heating in the workpiece bore for superior performance on solid components.



The TIH L MB heats non-bearing workpieces up to 600 kg (1 323 lb), depending on the model.



The TIH L MB induction heater is equipped with a remote control panel for operator safety.

Advice: The SKF TIH L MB series heaters are designed for induction heating of solid, non-bearing components. For bearing-heating applications, we recommend the use of equivalent SKF TIH L series heaters.

Induction heaters for non-bearing applications

TIH L MB series

The TIH L MB series provides the following advantages for quick and effective heating of solid workpieces:

- Simple and safe operation with remote-control and power level selection
- Superior heating performance for solid workpieces with low energy consumption
- Quick and easy placement of solid components with sliding yoke
- Automatic demagnetization reduces risk of ferrous debris contamination
- Easy to transport using standard forklift
- Available in three voltage variants to suit most operating voltages worldwide
- Available with three different operating areas



Technical data			
Designation	TIH L33MB	TIH L44MB	TIH L77MB
Maximum workpiece weight	350 kg (772 lb)	600 kg (1 323 lb)	600 kg (1 323 lb)
Bore diameter range	115–700 mm (4.5–27.6 in.)	150–800 mm (5.9–31.5 in.)	150–800 mm (5.9–31.5 in.)
Operating area (w × h)	330 × 320 mm (13.0 × 12.6 in.)	465 × 492mm (18.3 × 19.4 in.)	765 × 792mm (30.1 × 31.2 in.)
Coil diameter	150 mm (5.9 in.)	175 mm (6.9 in.)	175 mm (6.9 in.)
Standard yokes (included) to suit workpiece minimum bore diameter	115 mm (4.5 in.)	150 mm (5.9 in.)	150 mm (5.9 in.)
Max. power consumption	TIH L33MB/MV: 15 kVA TIH L33MB/LV: 15 kVA	TIH L44MB/LV: 20–24 kVA TIH L44MB/MV: 20–23 kVA	TIH L77MB/LV: 20–24 kVA TIH L77MB/MV: 20–23 kVA
Voltage ¹⁾			
200–240 V/50–60 Hz	TIH L33MB/LV	TIH L44MB/LV	-
400–460 V/50–60 Hz	TIH L33MB/MV	TIH L44MB/MV	TIH L77MB/MV
Temperature control	0–250 °C (32–482 °F); in steps of 1°	0–250 °C (32–482 °F); in steps of 1°	0–250 °C (32–482 °F); in steps of 1°
Time control	0–120 minutes; in steps of 0.1 minute	0–120 minutes; in steps of 0.1 minute	0–120 minutes; in steps of 0.1 minute
Demagnetisation according to SKF norms	<2A/cm	<2A/cm	<2A/cm
Maximum heating temperature ²⁾	250 °C (482 °F)	250 °C (482 °F)	250 °C (482 °F)
Dimensions (w × d × h)	400 × 743 × 550 mm (15.8 × 29.3 × 21.7 in.)	1 200 × 600 × 850 mm (47.3 × 23.6 × 33.5 in.)	1 320 × 600 × 1 150 mm (52 × 23.6 × 45.3 in.)
Weight	140 kg (309 lb)	324 kg (714 lb)	415 kg (915 lb)

¹⁾ Some special voltage versions (e.g. 575V, 60Hz CSA ready) are available for specific countries. For additional information, please contact your local SKF authorised distributor.

²⁾ Depending on bearing or workpiece weight. For higher temperatures, please contact SKF.

A flexible heating solution for very large bearings and workpieces

Multi-core induction heaters, TIH MC series

The SKF multi-core induction heaters are energy efficient, custom-made heating solutions. Compared to other heating methods, they often can significantly save heating time. The TIH MC series are similar to the standard TIH range, with a few key differences and additional features:

- Flexible design, consisting of a number of induction heating cores and coils controlled by a single control and power cabinet
- Suitable for heating large thin section workpieces, such as slewing rings and railway wheel tyres
- Heating capacities of several tonnes are possible, depending on application
- Enables a more even temperature gradient across the whole circumference. This is especially important for components sensitive to uneven induction heating
- Unique design allows for custom-made solutions to be quickly and economically produced



SKF can configure the type of TIH MC series heater required, depending on the application. For additional information, contact your SKF authorised distributor

Heating tools

Dismounting

SKF's range of heating equipment enables quick and safe dismounting of cylindrical roller bearing inner rings and covers a wide range of applications. Aluminium heating rings TMBR series are designed for dismounting inner rings of small and medium-size cylindrical roller bearings. Adjustable and fixed induction heaters EAZ series are suitable for frequent dismounting of various sizes of cylindrical roller bearing inner rings.

For regular dismounting of cylindrical roller bearings

Aluminium heating rings TMBR series

The aluminium heating rings are designed for dismounting inner rings of cylindrical roller bearings. After pre-heating the TMBR ring, it is clamped on the bearing inner ring to rapidly transfer the heat to the bearing ring and expand it for dismounting.

- Simple and easy-to-use
- Avoids shaft and bearing inner ring damage

Technical data

Designation	TMBR + bearing designation (e.g. TMBR NU216E)
Material	Aluminium
Maximum temperature	300 °C (572 °F)



SKF Aluminium Heating Rings TMBR series are produced to accurately fit a specific bearing ring. The lists with ordering details make it easy to find the right TMBR for a given bearing designation.

Orderings details - others

Bearing/ring designation	TMBR designation;
313822	TMBR 313822
NJ 130x240 TN_VA820 NJP 130x240 TN_VA820	TMBR NJ130X240
NJ 160x270 NJP 160x270	TMBR NJ160X270
NJ 120x240 TN/VA820 NJP 120x240 TN/VA820	TMBR 120X240
NJ 218 & NJ 218 E...	TMBR NJ218E
NJ 2318 E...	TMBR NJ2318E
NNU4930	TMBR NNU4930
NUP 215	TMBR NUP215

Dismounting procedure

- A** Clean the shaft, inner ring and aluminium ring. Make sure that there are no damages on the shaft that could prevent the bearing ring removal.
- B** Coat the raceway of the inner ring with an oil with following specifications:
- heat resisting 280 °C (536 °F)
 - heat transmitting
 - rust preventing
 - high viscosity
- C** Heat the aluminium ring to 280 °C (536 °F). For correct temperature control SKF advises the use of a thermometer, e.g. SKF Thermometer TKDT 10 or SKF Infrared Thermometer TKTL 31 which are both supplied with the standard surface probe TMDT 2-30.
- D** Place the aluminium ring around the bearing inner ring and press the handles together (or clamp locking device). Wait for a short time, then try to rotate the tool with the ring until it comes loose from the shaft.

Orderings details - NU

Bearing/ring designation	TMBR designation;
NU 1011 & NU 1011 E...	TMBR NU1011EC
NU 1018 M	TMBR NU1018
NU 1036 ML	TMBR NU1036
NU 206 E...	TMBR NU206EC
NU 209 E...	TMBR NU209E
NU 212	TMBR NU212
NU 213	TMBR NU213
NU 213 E...	TMBR NU213E
NU 214	TMBR NU214
NU 214 E...	TMBR NU214EC
NU 215	TMBR NU215
NU 215 E...	TMBR NU215EC
NU 216 & NU 216 E...	TMBR NU216EC
NU 217 E...	TMBR NU217EC
NJ 218 & NJ 218 E...	TMBR NU218
NU 218 & NU 218 E...	TMBR NU219E
NU 2212 E...	TMBR NU2212EC
NU 2214 E...	TMBR NU2214E
NU222	TMBR NU222
NU 2224 & NU 2224 E...	TMBR NU2224E
NU 226 E...	TMBR NU226EC
NU 236 E...	TMBR NU236E
NU 238 E...	TMBR NU238EC
NU 311	TMBR NU311
NU 312	TMBR NU312
NU 312 E...	TMBR NU312EC
NU 313	TMBR NU313
NU 314	TMBR NU314
NU 315	TMBR NU315
NU 316	TMBR NU316
NU 316 E...	TMBR NU316E
NU 317	TMBR NU317
NU 318 E ...	TMBR NU318E
NU 319	TMBR NU319
NU 320 E...	TMBR NU320EC
NU 322 & NU 322 E...	TMBR NU322
NU 324	TMBR NU324
NU 1011EC	TMBR NUB1011EC

Heating tools

Safe and easy bearing removal in just 3 minutes

Fixed induction heater EAZ series

The fixed size EAZ induction heaters are designed to safely and easily dismount, and mount, cylindrical roller bearing inner rings, which are often mounted with a very tight interference fit. The modular EAZ solution consists of one or two EAZ coils that are fitted for the application and connected to a matching control cabinet to power and operate the coil.

- **Perfect fit** - EAZ coils are specifically designed for a given inner ring to achieve optimum dismounting performance and safe operation.
- **Easy handling** - The lifting eye, two handles and a mechanism to lock the bearing inner ring inside the coil streamlines the dismounting process and helps the operator to safely handle the heater and hot ring.
- **Overheating protection** - The EAZ coils are equipped with an overheating protection circuit that stops the heating process when the internal coil temperature starts overheating.

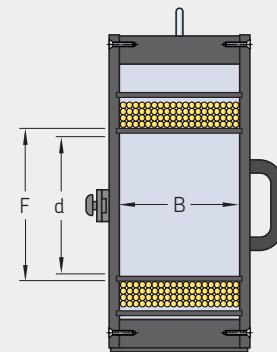

Bearing			Fixed EAZ coil		
Designation	Inner ring dimension (mm)			Designation	Voltage and current information
	F	B	d		
315189 A	179	168	160	EAZ F179MV	MV: 400 V, 105 A / HV: 500 V, 80 A
314190	180	130	160	EAZ F180MV	MV: 400 V, 85 A / HV: 500 V, 65 A
313812	202	168	180	EAZ F202MV	MV: 400 V, 95 A / HV: 500 V, 70 A
313893	222	200	200	EAZ F222MV	MV: 400 V, 125 A / HV: 500 V, 95 A
313811	226	192	200	EAZ F226MV	MV: 400 V, 120 A / HV: 500 V, 95 A
313824	260	206	230	EAZ F260MV	MV: 400 V, 160 A / HV: 500 V, 120 A
313822	312	220	280	EAZ F312MV	MV: 400 V, 160 A / HV: 500 V, 120 A

Cylindrical roller bearings are essential machine components for applications in steel, railway and other industries. In many cases cylindrical roller bearings experience harsh operating conditions and need to be replaced frequently. Fixed size EAZ heaters and corresponding control cabinets offer fast, easy and safe dismounting and mounting of cylindrical roller bearing inner rings and similar components. Heating the inner ring creates expansion that overcomes the interference fit and allows the ring to be moved without damaging the shaft or the ring.

Fixed EAZ coils are made upon request to perfectly match your SKF bearing or ring dimensions and voltage execution. Please specify your application and supply detailed information with your request to your SKF partner.





Intuitive usage Control cabinets

The SKF EAZ control cabinets are designed to enable the easy operation of the EAZ coils. It allows the user to conveniently set the heating parameters and control the heating process.

- **Intuitive usage** - The control cabinets feature an intuitive touch screen that helps the operator to quickly set up the heater and control the heating progress.
- **Automatic temperature control** - The control cabinets can automatically stop the heating process when the desired temperature is reached by utilizing a temperature probe on the inner ring.
- **Demagnetization for mounting and dismounting** - The control cabinets feature automatic demagnetization at the end of the heating process. This reduces contamination risks and allows the EAZ system to be used for both mounting and dismounting applications.
- **CCD version for two coils** - For applications where different EAZ coils are required (e.g. one coil to remove a labyrinth seal ring and another coil to remove a double-row CRB), both EAZ coils can be permanently connected to the cabinet and the user can select which coil is operated.

Technical data – EAZ control cabinets

Designation	No. of outputs	Voltage (+/- 5%)	Frequency	Max. amperage limit
EAZ CC 225B	1x EAZ coil	400 V	50 Hz/60 Hz	225 A
EAZ CC 350B	1x EAZ coil	400 V	50 Hz/60 Hz	350 A
EAZ CC 225A	1x EAZ coil	500 V	50 Hz/60 Hz	225 A
EAZ CC 350A	1x EAZ coil	500 V	50 Hz/60 Hz	350 A
EAZ CCD 225B	2x EAZ coil	400 V	50 Hz/60 Hz	225 A
EAZ CCD 350B	2x EAZ coil	400 V	50 Hz/60 Hz	350 A
EAZ CCD 225A	2x EAZ coil	500V	50 Hz/60 Hz	225 A
EAZ CCD 350A	2x EAZ coil	500 V	50 Hz/60 Hz	350 A
EAZ CC 225C	1x EAZ coil	440 to 480 V	50 Hz/60 Hz	225 A
EAZ CC 350C	1x EAZ coil	440 to 480 V	50 Hz/60 Hz	350 A
EAZ CCD 250C	2x EAZ coil	440 to 480 V	50 Hz/60 Hz	225 A
EAZ CCD 350C	2x EAZ coil	440 to 480 V	50 Hz/60 Hz	350 A



Two different menus for mounting and dismounting with an intuitive touch screen navigation



Easy operation with automatic temperature control that stops the heater when the selected temperature for mounting or dismounting is reached.



Heating tools

Accessories

For safe handling of heated components up to 150 °C (302 °F)

Heat resistant gloves TMBA G11

The TMBA G11 are specially designed for the handling of heated bearings.

- Heat resistant up to 150 °C (302 °F)
- Low lint
- Cut resistant
- Non allergenic
- Tested and certified for mechanical risks (EN 388) and thermal risks (EN 407)
- Fits a wide range of hand sizes



Technical data	
Designation	TMBA G11
Material outer	Polyester
Material inner	Cotton
Size	9
Colour	White
Max. recommended temperature	150 °C (302 °F)
Pack size	1 pair





For safe handling of heated components up to 500 °C (932 °F)

Extreme temperature gloves TMBA G11ET

The TMBA G11ET are especially designed for the safe handling of heated bearings or other components for prolonged periods.

- Withstands extreme temperatures of up to 400 °C (752 °F) unless in the presence of hot liquid or steam
- Allows the safe handling of heated components
- High-degree of non-flammability reduces the risk of burning
- Extremely tough Kevlar gloves with high cut, abrasion, puncture and tear resistance for increased safety
- Non-allergenic
- Tested and certified for mechanical risks (EN 388) and thermal risks (EN 407)

Technical data

Designation	TMBA G11ET
Material outer	Para-aramid
Material middle	Para-aramid
Material inner	Cotton
Size	10
Colour	Yellow
Max. recommended temperature	400 °C (752 °F)
Pack size	1 pair



For safe handling of oily and heated components up to 250 °C (482 °F)

Heat and oil resistant gloves TMBA G11H

The TMBA G11H are specially designed for the handling of hot and oily bearings.

- Offers a high degree of heat, cut, oil and water resistance
- Melt and burn resistant
- Heat resistant up to 250 °C (482 °F)
- Abrasion, cut, tear and puncture resistant
- Remains heat resistant when wet
- Suitable for submerging in liquids with a temperature up to 120 °C (248 °F) (e.g. hot oil bath)
- Tested and certified for mechanical risks (EN 388) and thermal risks (EN 407)
- Non-allergenic
- Fits a wide range of hand sizes

Technical data

Designation	TMBA G11H
Material outer	Para-aramid
Material middle	
Material inner	Cotton
Size	10
Colour	Yellow
Max. recommended temperature	250 °C (482 °F)
Pack size	1 pair

Hydraulic tools

Mounting and dismounting bearings and similar components using hydraulic techniques

SKF pioneered the use of hydraulic techniques for mounting bearings and associated items many years ago. Nowadays, the SKF hydraulic techniques are often the preferred mounting and dismounting method for larger bearings as well as other components. These techniques have helped to simplify bearing arrangements and facilitate correct and easy mounting. Using SKF hydraulic techniques for bearing or component dismounting reduces the risk of damaging the item or its seating. Additionally, greater withdrawal forces can be applied with less effort and maximum control, allowing quick and safe dismounting.

With the SKF hydraulic mounting and dismounting techniques, you can achieve:

- More control, allowing precision, accuracy and repeatability to be maintained
- Lower risk of damaging bearings, components and shafts
- Less manual effort
- Greater operator safety



Easy way to mount and dismount bearings and components

SKF Oil Injection Method

The SKF Oil Injection Method allows bearings and other components with an interference fit to be fitted in a safe, controllable and rapid manner. The method does not require keyways to be machined on the shaft, saving valuable time and money in materials and production. Interference fits have long been recognised for their reliability in transmitting large torsional loads. Very often, interference fits offer the only solution when connecting hubs to shafts with intermittent or fluctuating loads.

Easy, quick and effortless bearing dismounting

When using the SKF Oil Injection Method, the mating surfaces are separated by a thin film of oil injected under high pressure, thereby virtually eliminating the friction between them. The method is versatile as it can be used for dismounting bearings and other components mounted on either cylindrical or tapered seatings. When dismounting items mounted on cylindrical seatings, the injected oil can reduce the required pulling forces by up to 90%.

When using the SKF Oil Injection Method to dismount bearings and components mounted on tapered seatings, the interference fit is completely overcome by the injected oil. The item is then ejected from the seating with great force, making the use of a puller unnecessary. In this case, a stop-nut must be used to control the ejection of the item. For bearing mounting and dismounting applications, the required oil pressure is typically less than 100 MPa (14 500 psi) and SKF hydraulic pumps can usually be used. However for applications such as couplings, gear and railway wheels, pressures of 300 MPa (43 500 psi) are more typical and SKF oil injectors are preferred.

Mounting

Tapered shafts

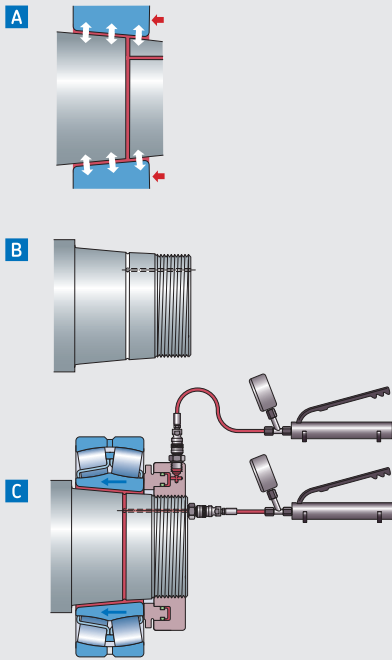

A The concept

Injecting oil between two tapered surfaces creates a thin oil film, which reduces the friction between them, thereby significantly reducing the mounting force required. The thin oil film also minimises the risk of metallic contact when mounting, reducing the risk of component damage.

B The preparation

During manufacture, the shafts are prepared with oil ducts and grooves. For technical information on how to prepare the shafts, consult an SKF application engineer.

C The action

Bearings are mounted by pushing them up the shaft with the aid of an SKF HMV .. E nut. The force to mount the bearing is reduced if oil is injected between the shaft and the bearing. This is often done with larger size bearings.

Dismounting

Cylindrical shafts

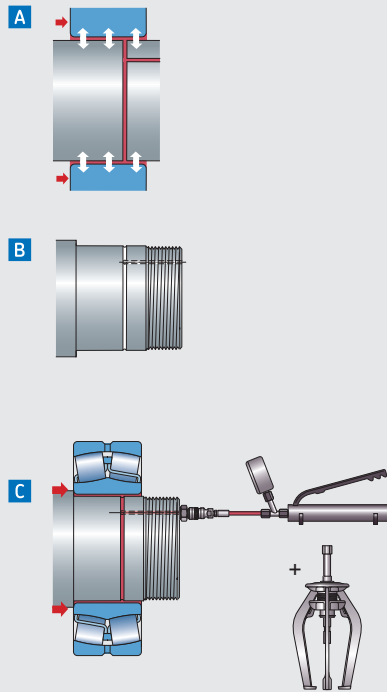

A The concept

By injecting oil of a certain viscosity between two shrink fitted surfaces, the mating surfaces will become separated by a thin oil film. The dismounting force required is thus greatly reduced. The thin oil film also minimises the risk of metallic contact when dismounting, reducing the risk of component damage.

B The preparation

During manufacture, the shafts are prepared with oil ducts and grooves. For technical information on how to prepare the shafts, consult an SKF application engineer.

C The action

Dismounting the bearing is made easier by pumping oil under pressure between the mating surfaces. Once the oil pressure has built up, the component can be removed from the shaft with a minimum of effort.

Tapered shafts

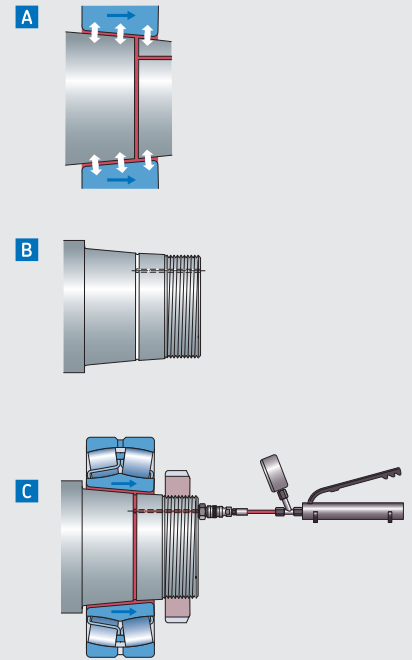

A The concept

Injecting the oil between two tapered surfaces will create a reaction force which could be quite substantial as the oil will also act as a “hydraulic cylinder” which can push the outer component off.

B The preparation

During manufacture, the shafts are prepared with oil ducts and grooves. For technical information on how to prepare the shafts, consult an SKF application engineer.

C The action

Bearings are dismounted by injecting oil between the mating surfaces and when sufficient pressure is reached, the bearing will be pushed off. A nut is required to keep the bearing from sliding off the shaft.

Hydraulic tools



Accurate mounting of SKF spherical roller and CARB toroidal roller bearings on tapered shafts and sleeves

SKF Drive-up Method

The SKF Drive-up Method is a well-proven method, unique to SKF, of accurately achieving the adjustment of SKF spherical roller and CARB toroidal roller bearings mounted on tapered seatings. The method incorporates the use of an SKF HMV ..E hydraulic nut fitted with a dial indicator, and a high accuracy digital pressure gauge, mounted on the selected pump.

The correct fit is achieved by controlling the axial drive-up of the bearing from a pre-determined starting position, defined by the pressure in the SKF HMV ..E hydraulic nut. The second stage is monitored by driving the bearing up a calculated distance on the taper seating.

The starting position pressure and the drive-up distance for many SKF bearings can be determined by using the SKF Drive-up Method PC program, available at skf.com or by downloading the iOS app for smartphones and tablets. In addition, SKF's unique information service for mounting and dismount bearings, skf.com/mount, also features the SKF Drive-up Method.

- More accurate and easier than using feeler gauges
- Greatly reduces the time to mount spherical roller and CARB toroidal roller bearings
- The only suitable way to mount SKF sealed spherical roller and CARB bearings

The SKF Drive-up Method



Download on the
App Store

Products for the SKF Drive-up Method

Designation	Description
HMV ..E (e.g. HMV 54E)	Metric thread hydraulic nut
HMVC ..E (e.g. HMVC 54E)	Inch thread hydraulic nut
729124 DU (for nuts ≤ HMV 54E)	Pump with digital gauge (MPa/psi)
TMJL 100DU (for nuts ≤ HMV 92E)	Pump with digital gauge (MPa/psi)
TMJL 50DU (all sizes HMV ..E nuts)	Pump with digital gauge (MPa/psi)
THGD 100	Digital gauge only (MPa/psi)
TMCD 10R	Horizontal dial indicator (0–10 mm)
TMCD 5P	Vertical dial indicator (0–5 mm)
TMCD 1/2R	Horizontal dial indicator (0–0.5 in.)

Technical data – Hydraulic pumps

Designation	729124 DU	TMJL 100DU	TMJL 50DU
Max. pressure	100 MPa (14 500 psi)	100 MPa (14 500 psi)	50 MPa (7 250 psi)
Volume/stroke	0.5 cm ³ (0.03 in. ³)	1.0 cm ³ (0.06 in. ³)	3.5 cm ³ (0.21 in. ³)
Oil container capacity	250 cm ³ (15 in. ³)	800 cm ³ (48 in. ³)	2 700 cm ³ (165 in. ³)
Digital pressure gauge unit	MPa/psi	MPa/psi	MPa/psi

Note: All above pumps are supplied complete with digital pressure gauge, high pressure hose and quick connect coupling.

Step by step procedure

One sliding surface

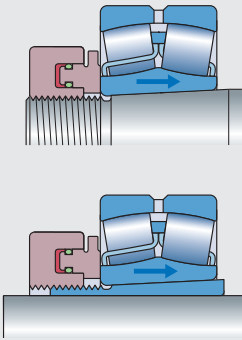

1. Determine whether one or two surfaces slide during mounting; see figures.
2. Lightly oil all mating surfaces with a thin oil, e.g. SKF LHM 300, and carefully place the bearing on the shaft.
3. Use the SKF Drive-up Method program or app or skf.com/mount to calculate the initial pressure value and required drive-up distance appropriate to the bearing and the mounting arrangement.
4. Drive the bearing up to the starting position by applying the required hydraulic nut pressure. The pressure is monitored on the digital pressure gauge fitted to the appropriate pump.

Two sliding surfaces

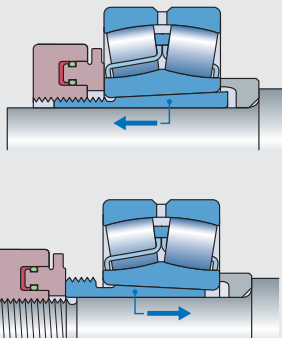

5. Drive the bearing up the taper by the calculated distance as given by the program, app or skf.com/mount. The axial drive-up is best monitored by a dial indicator. The SKF Hydraulic Nut HMV ..E is prepared for dial indicators. The bearing is now mounted with a suitable interference on the shaft and a suitable residual clearance.



For use with previous generation of SKF HMV(C) hydraulic nuts

Hydraulic nut drive-up adapter HMVA 42/200

The SKF Drive-up Method is the preferred method for mounting SKF spherical roller and CARB toroidal roller bearings on tapered seatings. An adapter, used in conjunction with an SKF Dial Indicator, the adapter allows the previous generation of SKF HMV nuts to be used with the SKF Drive-up Method.

The adapter can be used with nuts from size SKF HMV(C) 42 to HMV(C) 200. The adapter is not required for the current generation of SKF HMV(C) ..E nuts.

- One adapter suits the previous generation nuts from SKF HMV(C) 42 up to 200
- Rugged construction
- Easy to attach to the SKF HMV nut using strong magnets
- Used in conjunction with SKF dial indicators

Hydraulic tools

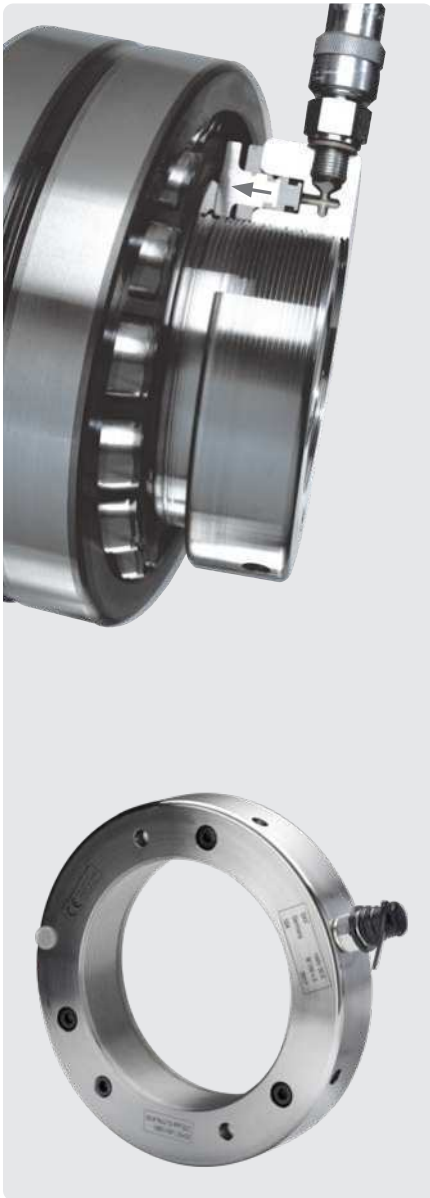

Easy application of high drive-up forces

Hydraulic nuts HMV ..E series

Mounting bearings on tapered seatings can be a difficult and time-consuming job. Using an SKF Hydraulic Nut facilitates easy and quick application of the high drive-up forces required for mounting bearings. Dismounting bearings mounted on either adapter or withdrawal sleeves is also often a difficult and time-consuming job. These problems can be reduced with the use of an SKF Hydraulic Nut. Oil is pumped into the nut and the piston is pushed out with a force, which is sufficient to free the sleeve. All SKF HMV ..E nuts are supplied with a quick connection coupling to fit the SKF hydraulic pumps.

- Wide size range, covering shaft diameters from 50 to 1 000 mm as standard
- Full range of inch threads available, series HMVC ..E from 1.967 up to 37.410 in.
- Quick connection coupling can be fitted on the face or side of the nut, allowing the nut to be used in areas where space is limited
- A spare set of piston seals and maintenance kit is supplied as standard
- To assist nut threading, a tube of lubricant is supplied with all nuts of size HMV(C) 54E and larger
- To facilitate easy nut threading, all nuts from size HMV(C) 54E are equipped with two tommy bars and four mating holes on their front face
- Nuts from size HMV(C) 94E are equipped with eyebolts, allowing easy handling
- Nuts from size HMV(C) 94E have the starting position of the thread indicated, facilitating easy matching of thread positions on both the nut and mating thread
- Special threads and sizes available on request

Maximum working oil pressure with permitted piston displacement of HMV(C)...E nuts:

- HMV(C) 60E and smaller
80 MPa (11 600 psi)
- HMV(C) 62-100E
40 MPa (5 800 psi)
- HMV(C) 102E and larger
25 MPa (3 600 psi)

Technical data – HMV E series (metric)

Designation	HMV E
Thread form	
HMV 10E – HMV 40E	ISO 965 / 111-1980 tolerance class 6H
HMV 41E – HMV 200E	ISO 2901-1977 tolerance class 7H
Mounting fluid (recommended)	LHMF 300
Recommended pumps	
HMV 10E – HMV 54E	729124* / TMJL 100* / 728619 E / TMJL 50*
HMV 56E – HMV 92E	TMJL 100* / 728619 E / TMJL 50*
HMV 94E – HMV 200E	728619 E / TMJL 50*
Quick connection nipple	729832 A (included)
Other types available	
Inch series nuts	HMVC E series

* Also available with digital pressure gauge (see page 71)

Mounting

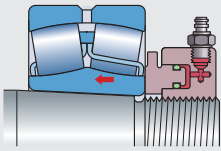

HMV ..E nut for driving the bearing onto a tapered seating.

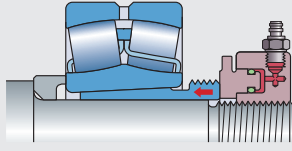

HMV ..E nut screwed onto the shaft for driving in a withdrawal sleeve.

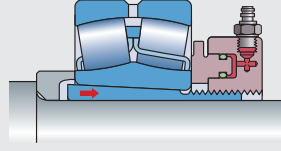

HMV ..E nut for driving the bearing onto an adapter sleeve.

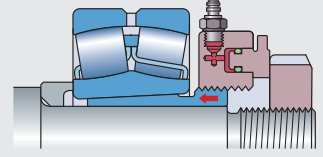

HMV ..E nut and special stop nut for driving in a withdrawal sleeve.

Dismounting

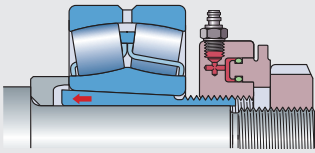

HMV ..E nut and stop ring in position to press an adapter sleeve free.

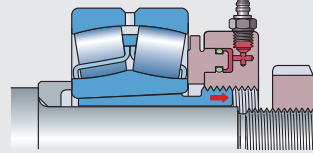

HMV ..E nut used to free a withdrawal sleeve.

Ordering details and dimensions – HMV E series (metric)

Designation	G	d ₁	d ₂	d ₃	B	B ₁	Permitted piston displacement	Piston area	Weight
	thread	mm	mm	mm	mm	mm	mm	mm ²	kg
HMV 10E	M50×1.5	50.5	104	114	38	4	5	2 900	2.70
HMV 11E	M55×2	55.5	109	120	38	4	5	3 150	2.75
HMV 12E	M60×2	60.5	115	125	38	5	5	3 300	2.80
HMV 13E	M65×2	65.5	121	130	38	5	5	3 600	3.00
HMV 14E	M70×2	70.5	127	135	38	5	5	3 800	3.20
HMV 15E	M75×2	75.5	132	140	38	5	5	4 000	3.40
HMV 16E	M80×2	80.5	137	146	38	5	5	4 200	3.70
HMV 17E	M85×2	85.5	142	150	38	5	5	4 400	3.75
HMV 18E	M90×2	90.5	147	156	38	5	5	4 700	4.00
HMV 19E	M95×2	95.5	153	162	38	5	5	4 900	4.30
HMV 20E	M100×2	100.5	158	166	38	6	5	5 100	4.40
HMV 21E	M105×2	105.5	163	172	38	6	5	5 300	4.65
HMV 22E	M110×2	110.5	169	178	38	6	5	5 600	4.95
HMV 23E	M115×2	115.5	174	182	38	6	5	5 800	5.00
HMV 24E	M120×2	120.5	179	188	38	6	5	6 000	5.25
HMV 25E	M125×2	125.5	184	192	38	6	5	6 200	5.35
HMV 26E	M130×2	130.5	190	198	38	6	5	6 400	5.65
HMV 27E	M135×2	135.5	195	204	38	6	5	6 600	5.90
HMV 28E	M140×2	140.5	200	208	38	7	5	6 800	6.00
HMV 29E	M145×2	145.5	206	214	39	7	5	7 300	6.50
HMV 30E	M150×2	150.5	211	220	39	7	5	7 500	6.60
HMV 31E	M155×3	155.5	218	226	39	7	5	8 100	6.95
HMV 32E	M160×3	160.5	224	232	40	7	6	8 600	7.60
HMV 33E	M165×3	165.5	229	238	40	7	6	8 900	7.90

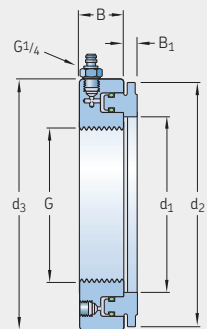
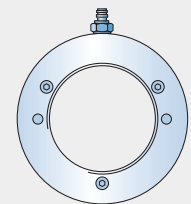

Hydraulic tools

Ordering details and dimensions – HMV E series (metric)

Designation	G	d ₁	d ₂	d ₃	B	B ₁	Permitted piston displacement	Piston area	Weight
	thread	mm	mm	mm	mm	mm	mm	mm ²	kg
HMV 34E	M170×3	170.5	235	244	41	7	6	9 400	8.40
HMV 36E	M180×3	180.5	247	256	41	7	6	10 300	9.15
HMV 38E	M190×3	191	259	270	42	8	7	11 500	10.5
HMV 40E	M200×3	201	271	282	43	8	8	12 500	11.5
HMV 41E	Tr205×4	207	276	288	43	8	8	12 800	12.0
HMV 42E	Tr210×4	212	282	294	44	8	9	13 400	12.5
HMV 43E	Tr215×4	217	287	300	44	8	9	13 700	13.0
HMV 44E	Tr220×4	222	293	306	44	8	9	14 400	13.5
HMV 45E	Tr225×4	227	300	312	45	8	9	15 200	14.5
HMV 46E	Tr230×4	232	305	318	45	8	9	15 500	14.5
HMV 47E	Tr235×4	237	311	326	46	8	10	16 200	16.0
HMV 48E	Tr240×4	242	316	330	46	9	10	16 500	16.0
HMV 50E	Tr250×4	252	329	342	46	9	10	17 600	17.5
HMV 52E	Tr260×4	262	341	356	47	9	11	18 800	19.0
HMV 54E	Tr270×4	272	352	368	48	9	12	19 800	20.5
HMV 56E	Tr280×4	282	363	380	49	9	12	21 100	22.0
HMV 58E	Tr290×4	292	375	390	49	9	13	22 400	22.5
HMV 60E	Tr300×4	302	386	404	51	10	14	23 600	25.5
HMV 62E	Tr310×5	312	397	416	52	10	14	24 900	27.0
HMV 64E	Tr320×5	322	409	428	53	10	14	26 300	29.5
HMV 66E	Tr330×5	332	419	438	53	10	14	27 000	30.0
HMV 68E	Tr340×5	342	430	450	54	10	14	28 400	31.5
HMV 69E	Tr345×5	347	436	456	54	10	14	29 400	32.5
HMV 70E	Tr350×5	352	442	464	56	10	14	29 900	35.0
HMV 72E	Tr360×5	362	455	472	56	10	15	31 300	35.5
HMV 73E	Tr365×5	367	460	482	57	11	15	31 700	38.5
HMV 74E	Tr370×5	372	466	486	57	11	16	32 800	39.0
HMV 76E	Tr380×5	382	476	498	58	11	16	33 500	40.5
HMV 77E	Tr385×5	387	483	504	58	11	16	34 700	41.0
HMV 80E	Tr400×5	402	499	522	60	11	17	36 700	45.5
HMV 82E	Tr410×5	412	510	534	61	11	17	38 300	48.0
HMV 84E	Tr420×5	422	522	546	61	11	17	40 000	50.0
HMV 86E	Tr430×5	432	532	556	62	11	17	40 800	52.5
HMV 88E	Tr440×5	442	543	566	62	12	17	42 500	54.0
HMV 90E	Tr450×5	452	554	580	64	12	17	44 100	57.5
HMV 92E	Tr460×5	462	565	590	64	12	17	45 100	60.0
HMV 94E	Tr470×5	472	576	602	65	12	18	46 900	62.0
HMV 96E	Tr480×5	482	587	612	65	12	19	48 600	63.0
HMV 98E	Tr490×5	492	597	624	66	12	19	49 500	66.0
HMV 100E	Tr500×5	502	609	636	67	12	19	51 500	70.0
HMV 102E	Tr510×6	512	624	648	68	12	20	53 300	74.0
HMV 104E	Tr520×6	522	634	658	68	13	20	54 300	75.0
HMV 106E	Tr530×6	532	645	670	69	13	21	56 200	79.0
HMV 108E	Tr540×6	542	657	682	69	13	21	58 200	81.0
HMV 110E	Tr550×6	552	667	693	70	13	21	59 200	84.0
HMV 112E	Tr560×6	562	678	704	71	13	22	61 200	88.0
HMV 114E	Tr570×6	572	689	716	72	13	23	63 200	91.0
HMV 116E	Tr580×6	582	699	726	72	13	23	64 200	94.0
HMV 120E	Tr600×6	602	721	748	73	13	23	67 300	100
HMV 126E	Tr630×6	632	754	782	74	14	23	72 900	110
HMV 130E	Tr650×6	652	775	804	75	14	23	76 200	115
HMV 134E	Tr670×6	672	796	826	76	14	24	79 500	120
HMV 138E	Tr690×6	692	819	848	77	14	25	84 200	127
HMV 142E	Tr710×7	712	840	870	78	15	25	87 700	135
HMV 150E	Tr750×7	752	883	912	79	15	25	95 200	146
HMV 160E	Tr800×7	802	936	965	80	16	25	103 900	161
HMV 170E	Tr850×7	852	990	1 020	83	16	26	114 600	181
HMV 180E	Tr900×7	902	1 043	1 075	86	17	30	124 100	205
HMV 190E	Tr950×8	952	1 097	1 126	86	17	30	135 700	218
HMV 200E	Tr1000×8	1 002	1 150	1 180	88	17	34	145 800	239

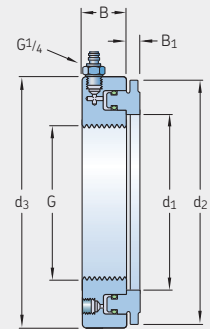
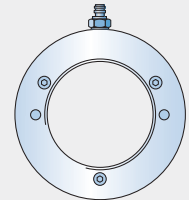



Technical data – HMVC E series (inch)

Designation	HMVC E
Thread form	
HMVC 10E – HMVC 64E	American National Form Threads Class 3
HMVC 68E – HMVC 190E	ACME General Purpose Threads Class 3 G
Mounting fluid	LHMF 300
Recommended pumps	
HMVC 10E – HMVC 52E	729124 / TMJL 100 / 728619 E / TMJL 50
HMVC 56E – HMVC 92E	TMJL 100 / 728619 E / TMJL 50
HMVC 94E – HMVC 190E	728619 E / TMJL 50
Quick connection nipple	729832 A (included)
Other types available	
Inch series nuts	HMVC E series

Ordering details and dimensions – HMVC E series (inch)

Designation	Pitch diameter		Threads	Permitted piston displacement					Piston area in. ²	Weight lb	
	G			d ₁	d ₂	d ₃	B	B ₁			
	in.	in.		in.	in.	in.	in.	in.			
HMVC 10E	1.967	1.9309	18	2.0	4.1	4.5	1.5	0.16	0.20	4.5	6.0
HMVC 11E	2.157	2.1209	18	2.2	4.3	4.7	1.5	0.16	0.20	4.9	6.1
HMVC 12E	2.360	2.3239	18	2.4	4.5	4.9	1.5	0.20	0.20	5.1	6.2
HMVC 13E	2.548	2.5119	18	2.6	4.8	5.1	1.5	0.20	0.20	5.6	6.6
HMVC 14E	2.751	2.7149	18	2.8	5.0	5.3	1.5	0.20	0.20	5.9	7.1
HMVC 15E	2.933	2.8789	12	3.0	5.2	5.5	1.5	0.20	0.20	6.2	7.5
HMVC 16E	3.137	3.0829	12	3.2	5.4	5.7	1.5	0.20	0.20	6.5	8.2
HMVC 17E	3.340	3.2859	12	3.4	5.6	5.9	1.5	0.20	0.20	6.8	8.3
HMVC 18E	3.527	3.4729	12	3.6	5.8	6.1	1.5	0.20	0.20	7.3	8.8
HMVC 19E	3.730	3.6759	12	3.8	6.0	6.4	1.5	0.20	0.20	7.6	9.5
HMVC 20E	3.918	3.8639	12	4.0	6.2	6.5	1.5	0.24	0.20	7.9	9.7
HMVC 21E	4.122	4.0679	12	4.2	6.4	6.8	1.5	0.24	0.20	8.2	10.3
HMVC 22E	4.325	4.2709	12	4.4	6.7	7.0	1.5	0.24	0.20	8.7	10.9
HMVC 24E	4.716	4.6619	12	4.7	7.0	7.4	1.5	0.24	0.20	9.3	11.6
HMVC 26E	5.106	5.0519	12	5.1	7.5	7.8	1.5	0.24	0.20	9.9	12.5
HMVC 28E	5.497	5.4429	12	5.5	7.9	8.2	1.5	0.28	0.20	10.5	13.2
HMVC 30E	5.888	5.8339	12	5.9	8.3	8.7	1.5	0.28	0.20	11.6	14.6
HMVC 32E	6.284	6.2028	8	6.3	8.8	9.1	1.6	0.28	0.24	13.3	16.8
HMVC 34E	6.659	6.5778	8	6.7	9.3	9.6	1.6	0.28	0.24	14.6	18.5
HMVC 36E	7.066	6.9848	8	7.1	9.7	10.1	1.6	0.28	0.24	16.0	20.2
HMVC 38E	7.472	7.3908	8	7.5	10.2	10.6	1.7	0.31	0.28	17.8	23.1
HMVC 40E	7.847	7.7658	8	7.9	10.7	11.1	1.7	0.31	0.31	19.4	25.4
HMVC 44E	8.628	8.5468	8	8.7	11.5	12.0	1.7	0.31	0.35	22.3	29.8
HMVC 46E	9.125	9.0440	8	9.1	12.0	12.5	1.8	0.31	0.35	24.0	31.9
HMVC 48E	9.442	9.3337	6	9.5	12.4	13.0	1.8	0.35	0.39	25.6	35.3
HMVC 52E	10.192	10.0837	6	10.3	13.4	14.0	1.9	0.35	0.43	29.1	41.9
HMVC 54E	10.604	10.4960	6	10.7	13.9	14.5	1.9	0.35	0.47	30.7	45.2
HMVC 56E	11.004	10.8957	6	11.1	14.3	15.0	1.9	0.35	0.47	32.7	48.5
HMVC 60E	11.785	11.6767	6	11.9	15.2	15.9	2.0	0.39	0.55	36.6	56.2
HMVC 64E	12.562	12.4537	6	12.7	16.1	16.9	2.1	0.39	0.55	40.8	65.0
HMVC 68E	13.339	13.2190	5	13.5	16.9	17.7	2.1	0.39	0.55	44.0	69.4
HMVC 72E	14.170	14.0500	5	14.3	17.9	18.6	2.2	0.39	0.59	48.5	78.3
HMVC 76E	14.957	14.8370	5	15.0	18.7	19.6	2.3	0.43	0.63	51.9	89.3
HMVC 80E	15.745	15.6250	5	15.8	19.6	20.6	2.4	0.43	0.67	56.9	100
HMVC 84E	16.532	16.4120	5	16.6	20.6	21.5	2.4	0.43	0.67	62.0	110
HMVC 88E	17.319	17.1990	5	17.4	21.4	22.3	2.4	0.47	0.67	65.9	119
HMVC 92E	18.107	17.9870	5	18.2	22.2	23.3	2.5	0.47	0.67	69.9	132
HMVC 96E	18.894	18.7740	5	19.0	23.1	24.1	2.6	0.47	0.75	75.3	139
HMVC 100E	19.682	19.5620	5	19.8	24.0	25.0	2.6	0.47	0.75	79.8	154

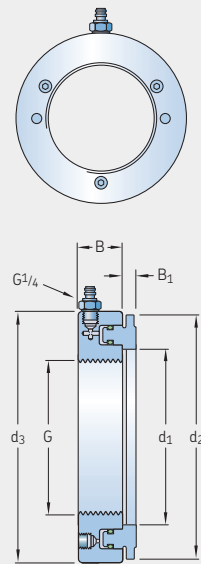

Hydraulic tools

Ordering details and dimensions – HMVC E series (inch)

Designation	Pitch diameter		Threads	Pitch diameter			B	B ₁	Permitted piston displacement	Piston area	Weight
	G			d ₁	d ₂	d ₃					
	in.	in.		in.	in.	in.	in.	in.	in. ²	lb	
HMVC 106E	20.867	20.7220	4	20.9	25.4	26.4	2.7	0.51	0.83	87.1	174
HMVC 112E	22.048	21.9030	4	22.1	26.7	27.7	2.8	0.51	0.87	94.9	194
HMVC 120E	23.623	23.4780	4	23.7	28.4	29.4	2.9	0.51	0.91	104.3	220
HMVC 126E	24.804	24.6590	4	24.9	29.7	30.8	2.9	0.55	0.91	113.0	243
HMVC 134E	26.379	26.2340	4	26.5	31.3	32.5	3.0	0.55	0.94	123.2	265
HMVC 142E	27.961	27.7740	3	28.0	33.1	34.3	3.1	0.59	0.98	135.9	298
HMVC 150E	29.536	29.3490	3	29.6	34.8	35.9	3.1	0.59	0.98	147.6	322
HMVC 160E	31.504	31.3170	3	31.6	36.9	38.0	3.1	0.63	0.98	161.0	355
HMVC 170E	33.473	33.2860	3	33.5	39.0	40.2	3.3	0.63	1.02	177.6	399
HMVC 180E	35.441	35.2540	3	35.5	41.1	42.3	3.4	0.67	1.18	192.4	452
HMVC 190E	37.410	37.2230	3	37.5	43.2	44.3	3.4	0.67	1.18	210.3	481

Hydraulic pumps and oil injectors

THAP 030E

Air-driven hydraulic pump
30 MPa (4 350 psi)



TMJL 50

Hydraulic pump
50 MPa (7 250 psi)



729124

Hydraulic pump
100 MPa (14 500 psi)



TMJL 100

Hydraulic pump
100 MPa (14 500 psi)



728619 E

Hydraulic pump
150 MPa (21 750 psi)



THAP 150E

Air-driven hydraulic pump
150 MPa (21 750 psi)



THHP 300

Hydraulic pump
300 MPa (43 500 psi)



THAP 300E

THAP 400E
Air-driven oil injectors 300 MPa (43 500 psi)
400 MPa (58 000 psi)



226400 E 226400 E/400

Oil injectors
300 MPa (43 500 psi)
400 MPa (58 000 psi)



Hydraulic pump and oil injector selection guide

Max. working pressure	Pump	Type	Oil container capacity	Connection nipple	Application examples ¹⁾
30 MPa (4 350 psi)	THAP 030E	Air-driven pump	Separate container	G 3/4	SKF OK Coupling hydraulic chamber
50 MPa (7 250 psi)	TMJL 50 ²⁾	Hand operated pump	2 700 cm ³ (165 in. ³)	G 1/4	All SKF HMV..E hydraulic nuts SKF OK Coupling hydraulic chamber
100 MPa (14 500 psi)	729124 ²⁾	Hand operated pump	250 cm ³ (15 in. ³)	G 1/4	SKF HMV..E hydraulic nuts of size HMV 54 and smaller Oil injection for small bearing seatings
	TMJL 100 ²⁾	Hand operated pump	800 cm ³ (48 in. ³)	G 1/4	SKF HMV..E hydraulic nuts of size HMV 92 and smaller Oil injection for medium bearing seatings
150 MPa (21 750 psi)	THAP 150E	Air-driven pump	Separate container	G 3/4	Bolt tensioners, propellers Oil injection for large bearing seatings
	728619 E	Hand operated pump	2 550 cm ³ (155 in. ³)	G 1/4	SKF HMV..E hydraulic nuts Oil injection for large bearing seatings and SKF Supergrip bolts
300 MPa (43 500 psi)	THAP 300E	Air-driven oil injector	Separate container	G 3/4	OK Couplings Large pressure joints Oil injection for large gears and railway wheels
	226400 E	Hand operated oil injector	200 cm ³ (12.2 in. ³)	G 3/4	OK Couplings Oil injection for gears and railway wheels Pressure joints
	THHP 300	Hand operated pump	1 800 cm ³ (110 in. ³)	G 1/4 G 3/4	OK Couplings Oil injection for gears and railway wheels Pressure joints
400 MPa (58 000 psi)	THAP 400E	Air-driven oil injector	Separate container	G 3/4	OK Couplings Large pressure joints Oil injection for large gears and railway wheels
	226400 E/400	Hand operated oil injector	200 cm ³ (12.2 in. ³)	G 3/4	OK Couplings Oil injection for gears and railway wheels Pressure joints

¹⁾ The interference fit and application size may mean that a pump / injector with a higher pressure and/or container volume is required.

²⁾ Also available with digital pressure gauge (see page 71)

Hydraulic tools

Hydraulic pumps



50 MPa (7 250 psi)

Hydraulic pump TMJL 50

The SKF TMJL 50 is mainly intended for larger SKF Hydraulic Nuts and SKF OK Coupling hydraulic chambers, but is also suitable for applications where a maximum pressure of 50 MPa (7 250 psi) is required.

- Large oil container capacity 2 700 cm³ (165 in.³)
- Over pressure valve and connection port for a pressure gauge
- Packed in a sturdy protective case

Applications

- SKF OK Coupling hydraulic chambers
- All sizes SKF Hydraulic Nuts
- Oil injection applications where the maximum pressure is 50 MPa (7 250 psi)



100 MPa (14 500 psi)

Hydraulic pump 729124

The SKF 729124 is mainly intended for SKF Hydraulic Nuts (≤ HMV 54E) to mount bearings or components where a maximum pressure of 100 MPa (14 500 psi) is required.

- Oil container capacity 250 cm³ (15 in.³)
- Fitted with a pressure gauge
- Packed in a sturdy carrying case

Applications

- SKF Hydraulic Nuts ≤ HMV 54E
- Oil injection applications where the maximum pressure is 100 MPa (14 500 psi)

Technical data	TMJL 50	729124	TMJL 100	728619 E
Designation	TMJL 50	729124	TMJL 100	728619 E
Maximum pressure	50 MPa (7 250 psi)	100 MPa (14 500 psi)	100 MPa (14 500 psi)	150 MPa (21 750 psi)
Oil container capacity	2 700 cm ³ (165 in. ³)	250 cm ³ (15 in. ³)	800 cm ³ (48 in. ³)	2 550 cm ³ (155 in. ³)
Volume/stroke	3.5 cm ³ (0.21 in. ³)	0.5 cm ³ (0.03 in. ³)	1.0 cm ³ (0.06 in. ³)	1st stage: 20 cm ³ below 2.5 MPa (1.2 in. ³ below 362 psi) 2nd stage: 1 cm ³ above 2.5 MPa (0.06 in. ³ above 362 psi)
Length of pressure hose fitted with quick connection coupling	3 000 mm (118 in.)	1 500 mm (59 in.)	3 000 mm (118 in.)	3 000 mm (118 in.)
Connection nipple (included)	G ¹ / ₄ quick connection	G ¹ / ₄ quick connection	G ¹ / ₄ quick connection	G ¹ / ₄ quick connection
Weight	12 kg (26 lb)	3.5 kg (8 lb)	13 kg (29 lb)	11.4 kg (25 lb)

All SKF Hydraulic Pumps are filled with SKF Mounting Fluid and are supplied with an extra litre of fluid.



Large oil container 100 MPa (14 500 psi)

Hydraulic pump TMJL 100

The SKF TMJL 100 pump is mainly intended for use with hydraulic nuts (\leq HMV 92E) to mount bearings or components where a maximum pressure of 100 MPa (14 500 psi) is required.

- Oil container capacity 800 cm³ (48 in.³)
- Fitted with a pressure gauge
- Packed in a sturdy protective case

Applications

- SKF Hydraulic Nuts \leq HMV 92E
- Oil injection applications where the maximum pressure is 100 MPa (14 500 psi)
- Suitable with SKF Hydraulic Assisted Pullers TMHP series



150 MPa (21 750 psi)

Hydraulic pump 728619 E

The SKF 728619 E is a two-stage pump suitable for use with SKF Supergrip Bolts and to mount bearings or components where a maximum pressure of 150 MPa (21 750 psi) is required.

- Oil container capacity 2 550 cm³ (155 in.³)
- Two stage pressure pumping
- Fitted with a pressure gauge
- Packed in a sturdy protective case

Applications

- SKF Supergrip Bolts
- Oil injection applications where the maximum pressure is 150 MPa (21 750 psi)
- All sizes SKF Hydraulic Nuts



LHM 300



LHDF 900

Mounting fluid LHM 300 and Dismounting fluid LHDF 900

The mounting and dismounting fluids are suitable for use with SKF hydraulic equipment, including hydraulic pumps, HMV ..E nuts and oil injection tools in mounting and dismounting jobs. All SKF Hydraulic pumps are filled with mounting fluid LHM 300 and are supplied with an extra litre of fluid.

For more information, see page 81

Hydraulic tools

Easy-to-connect manual hydraulic pump develops oil pressures up to 300 MPa (43 500 psi)

Hydraulic pump THHP 300

The THHP 300 is a high pressure, hand-operated hydraulic pump that is suitable for many applications using the SKF Oil Injection Method, for oil pressures up to 300 MPa (43 500 psi). It can be used straight from the case: mount the appropriate THPN nipple on the application and then screw on the quick connection nipple. Connecting the hose to the nipple on the application enables a supply of high pressure oil. The two stage pump includes a 0-300 MPa (0-43 500 psi) pressure gauge, high pressure hose and quick connection coupling. Connection nipples enable both G1/4 and G3/4 connections.

The THHP 300 is ready to use with minimal preparation – allowing oil injection to be applied straight away, speeding up mounting and dismantling.

Oil is automatically returned to the reservoir once pressure has been released, minimising the risk of leakage.

- Two stage pump design to quickly reach high pressures up to 300 MPa (43 500 psi)
- Large, mounted gauge shows pressures over the full pressure range
- Glycerine filled pressure gauge dampens shocks and pressure peaks, giving longer service life and is easier to read.
- Easy to use – it comes with a high-pressure hose, a quick connection coupling is included and various nipples to connect to the most common applications
- Applicable in wide range of industries including rail and marine
- Design minimises the risk of oil leaking into the environment
- Packed in a sturdy protective case



Applications

- Railway wheels
- Tyres, propellers, gears and other similar applications
- Oil injection applications where the maximum pressure is 300 MPa (43 500 psi)



Technical data

Designation	THHP 300		
Maximum pressure	300 MPa (43 500 psi)	Case dimensions	920 × 318 × 380 mm (36.2 × 12.5 × 15.0 in)
Volume per stroke 1st Stage	40 cm ³ (2.43 in ³) – below 1.6 MPa (232 psi)	Unit weight	7.5 kg (16.5 lb)
Volume per stroke 2nd Stage	0.5 cm ³ (0.03 in ³) – above 1.6 MPa (232 psi)	Total weight (incl. case)	20.4 kg (50 lb)
Oil reservoir capacity	1.8 litres (110 in ³) / 1.6 litres (97.6 in ³) usable	Case contents	1 × Hydraulic pump body 1 × High pressure hose 1 × Pressure gauge and protection sleeve 1 × Quick connection coupling 1 × Quick connection nipple 1 × Connection nipple M16 (m) - G1/4 (m) 1 × Connection nipple M16 (m) - G3/4 (m) 1 × Mounting fluid (1 litre)
Pressure gauge	0-300 MPa (0-43 500 psi) Diameter 100 mm (4 in) Accuracy 1% of full scale	Optional connection nipples	THPN M16G1/8 Connection nipple M16 (m) - G1/8 (m) THPN M16G3/8 Connection nipple M16 (m) - G3/8 (m) THPN M16G1/2 Connection nipple M16 (m) - G1/2 (m)
Hose length	2 m (78 in)		
Hose connection threads	G1/4 female to pump M16 male thread with special sealing design to attach to the quick connection coupling		
Maximum torque for M16 thread	40~50 Nm (29.5~36.9 ft-lb)		
Main dimensions of the pump (without hose and gauge)	574 × 130 × 200 mm (22.6 × 5.1 × 7.9 in)		

300 and 400 MPa (43 500 and 58 000 psi)

Oil injector 226400 E series

The 226400 E series is suitable for many applications using the SKF Oil Injection Method. The injector is supplied with an oil reservoir in a compact carrying case. The injector can be mounted directly onto the work piece or connected to an adapter block to make a floor standing model, making it easy to connect pressure gauges and high-pressure hoses. For applications where 400 MPa (58 000 psi) is required, the SKF 226400 E/400 is available.

- Easy to operate
- Compact carrying case
- When the pressure is released, the unused oil is automatically returned to the reservoir, minimizing the risk of oil leakage to the environment
- Oil container capacity 200 cm³ (12.2 in.³)
- Can be used with a wide range of accessories, such as:
 - Adapter block
 - Pressure gauges
 - High pressure hoses
 - Connecting nipples
- Supplied in a carrying case



Technical data		
Designation	226400 E	226400 E/400
Maximum pressure	300 MPa (43 500 psi)	400 MPa (58 000 psi)
Volume per stroke	0,23 cm ³ (0.014 in. ³)	0,23 cm ³ (0.014 in. ³)
Oil reservoir capacity	200 cm ³ (12.2 in. ³)	200 cm ³ (12.2 in. ³)
Connecting threads	G ³ / ₄	G ³ / ₄



Adapter block 226402

The adapter block SKF 226402 consists of a cast steel block to which a pressure gauge and high-pressure hose can be connected. It comes with a floor support and a 90 degree connection nipple for the oil reservoir. To be used in combination with 729101-CK (page 76) up to 300 MPa (43 500 psi).

Technical data	
Designation	226402
Maximum pressure	400 MPa (58 000 psi)
Pressure gauge connection	G ¹ / ₂
Pressure pipe connection	G ³ / ₄
Weight	2.55 kg (5.6 lb)

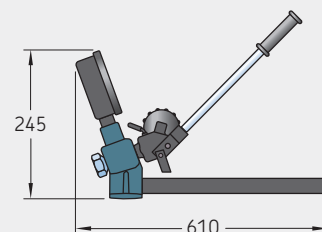

Hydraulic tools

30, 150, 300 and 400 MPa (4 350, 21 750, 43 500 and 58 000 psi)

Air-driven hydraulic pumps and oil injectors THAP E series

The THAP E air-driven hydraulic pumps and oil injectors are available in four different pressure versions. They can be used for mounting OK Couplings, large pressure joints such as bearings, flywheels, couplings and railway wheels. The THAP E unit consists of a hydraulic pump or high pressure oil injector, driven by an air motor.

The units are supplied in a sturdy case including oil suction and return hoses with quick connect couplings. The units can also be supplied in complete sets, consisting of a THAP E and such accessories as a pressure gauge and pressure hose.

- Time savings compared to hand operated pumps and oil injectors
- Portable
- Continuous supply of oil
- Internal air pressure limiter helps ensure safe operation
- Low air consumption
- Wide operating temperature range
- Sturdy storage boxes
- Low, medium and high pressure units

Applications

- SKF OK Couplings
- Mounting bearings
- Mounting ship propellers, rudder pintles, railway wheels and other similar applications



THAP 300E



THAP 400E/K10

Technical data

Designation	THAP 030E	THAP 150E	THAP 300E	THAP 400E
Nominal hydraulic pressure	30 MPa (4 350 psi)	150 MPa (21 750 psi)	300 MPa (43 500 psi)	400 MPa (58 000 psi)
Operating air pressure ¹⁾	7 bar (101.5 psi)	7 bar (101.5 psi)	7 bar (101.5 psi)	7 bar (101.5 psi)
Volume/stroke	10 cm ³ (0.61 in. ³)	1.92 cm ³ (0.12 in. ³)	0.83 cm ³ (0.05 in. ³)	0.64 cm ³ (0.039 in. ³)
Oil outlet	G ³ / ₄	G ³ / ₄	G ³ / ₄	G ³ / ₄
Length	350 mm (13.9 in.)	350 mm (13.9 in.)	405 mm (16 in.)	405 mm (16 in.)
Height	202 mm (8 in.)	202 mm (8 in.)	202 mm (8 in.)	202 mm (8 in.)
Width	171 mm (6.7 in.)	171 mm (6.7 in.)	171 mm (6.7 in.)	171 mm (6.7 in.)
Weight	11.5 kg (25.3 lb)	11.5 kg (25.3 lb)	13 kg (28.6 lb)	13 kg (28.6 lb)

Also available as complete set in carrying case

THAP 030E/SK1	Consisting of pump, pressure hose and connecting nipples.
THAP 150E/SK1	Consisting of pump, pressure gauge, pressure hose and connecting nipples.
THAP 300E/K10	Consisting of oil injector, pressure gauge, high pressure hose and connecting nipples.
THAP 400E/K10	Consisting of oil injector, pressure gauge, high pressure hose and connecting nipples.

¹⁾ Air pressures above 7 bar are automatically limited to 7 bar by an internal air limiter.

100 to 400 MPa (14 500 to 58 000 psi)

Pressure gauges

SKF Pressure Gauges are designed to fit SKF Hydraulic Pumps and SKF Oil Injectors. The gauges are all liquid filled and/or equipped with a restriction screw in order to absorb any sudden pressure drop thereby preventing damage. Safety glass and blowout discs are standard for all gauges and all have dual scales (MPa/psi).

- Covers pressures of 100 to 400 MPa (14 500 to 58 000 psi)
- Protection against sudden pressure drops
- Safety glass and blow out discs on all gauges
- Stainless steel case
- Dual scales MPa/psi
- Easy to read, high visibility yellow gauge faces



The Digital oil pressure gauge, THGD 100, is used to accurately measure the hydraulic pressure when mounting bearings using the SKF Drive-up Method.



1077587



1077589



1077589/3



1077587/2

Technical data

Designation	Pressure range		Diameter (H)		Connection thread	Weight		Accuracy % of full scale
	MPa	psi	mm	in.		kg	lb	
1077587	0–100	0–14 500	110	4.33	G ¹ / ₂	1.00	2.2	1
1077587/2	0–100	0–14 500	69	2.72	G ¹ / ₄	0.25	0.6	1.6
THGD 100 ¹⁾	0–100	0–14 500	79	3.10	G ¹ / ₄	0.54	1.2	0.1
1077589	0–300	0–43 500	110	4.33	G ¹ / ₂	1.00	2.2	1
1077589/3	0–400	0–58 000	110	4.33	G ¹ / ₂	1.00	2.2	1

¹⁾Digital pressure gauge

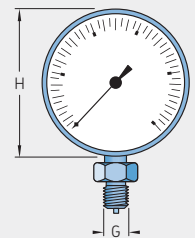

Hydraulic tools

Accessories



Maximum working pressure up to 400 MPa (58 000 psi)

Pressure hoses

The pressure hoses and high pressure hoses are designed to connect in an easy manner the SKF pumps and injector sets to the application with its pressure joint. They must be used together with the appropriate quick connection couplings and nipples according to the maximum pressure applied.

- Safety note:**

Pressure hoses are subject to ageing and after a number of years the performance deteriorates. All SKF Pressure hoses, except for 400MPa, are hard marked with the year in which their life expires. The 400MPa hoses are hard marked with a code to trace the production date.

Technical data						
Designation		729126	729834	THAP 300-H/2	THHP 300-2H	THAP 400-H/2
d		6.4 mm (0.25 in.)	4.8 mm (0.19 in.)	3.9 mm (0.15 in.)	3.9 mm (0.15 in.)	4.6 mm (0.18 in.)
D		13 mm (0.5 in.)	12 mm (0.5 in.)	12 mm (0.5 in.)	12 mm (0.5 in.)	15 mm (0.6 in.)
A		25.4 mm (1.0 in.)	25.4 mm (1.0 in.)	19.6 mm (0.77 in.)	25.4 mm (1.00 in.)	19.6 mm (0.77 in.)
E		19 mm (0.75 in.)	15 mm (0.6 in.)	19 mm (0.75 in.)	19 mm (0.75 in.)	23 mm (0.90 in.)
Maximum working pressure		100 MPa (14 500 psi)	150 MPa (21 750 psi)	300 MPa (43 500 psi)	300 MPa (43 500 psi)	400 MPa (58 000 psi)
Minimum bending radius		80 mm (3.2 in.)	130 mm (5.1 in.)	140 mm (5.5 in.)	140 mm (5.5 in.)	200 mm (7.9 in.)
End fitting - Left		G ¹ / ₄ (m)	G ¹ / ₄ (m)	M16x1.5 (m)	G ¹ / ₄ (f)	M16x1.5 (m)
End fitting - Right		G ¹ / ₄ (m)	G ¹ / ₄ (m)	M16x1.5 (m)	M16x1.5 (m)	M16x1.5 (m)
Spanner fitting - Left		Hex 22 (7/8")	Hex 22 (7/8")	Hex 17 mm (11/16")	Hex 22 mm (7/8")	Hex 17 mm (11/16")
Spanner fitting - Right		Hex 22 (7/8")	Hex 22 (7/8")	Hex 17 mm (11/16")	Hex 17 mm (11/16")	Hex 17 mm (11/16")
Tightening torque		40 Nm (29.5 ft-lb)	40 Nm (29.5 ft-lb)	45 Nm (33.2 ft-lb.)	45 Nm (33.2 ft-lb.)	45 Nm (33.2 ft-lb.)
Working temperature		-40 to 100 °C (-40 to 212 °F)	-10 to 100 °C (14 to 212 °F)	-20 to 80 °C (-4 to 176 °F)	-20 to 80 °C (-4 to 176 °F)	-20 to 80 °C (-4 to 176 °F)
Length		1 500 mm (59 in.)	3 000 mm (118 in.)	2 000 mm (79 in.)	2 000 mm (79 in.)	2 000 mm (79 in.)
Weight		0.65 kg (1.4 lb)	1.0 kg (2.2 lb)	1.0 kg (2.2 lb)	1.0 kg (2.2 lb)	1.7 kg (3.8 lb)

Other lengths available		
Designation	Length	Weight
THAP 300-H/3	3 000 mm (118 in.)	1.35 kg (3.0 lb)
THAP 300-H/4	4 000 mm (158 in.)	1.7 kg (3.8 lb)
THHP 300-2H/3	3 000 mm (118 in.)	1.35 kg (3.0 lb)
THHP 300-2H/4	4 000 mm (158 in.)	1.7 kg (3.8 lb)
THAP 400-H/3	3 000 mm (118 in.)	2.35 kg (5.2 lb)
THAP 400-H/4	4 000 mm (158 in.)	3.05 kg (6.7 lb)

729126	
729834	
THAP 300-H/2	
THHP 300-2H	
THAP 400-H/2	



Solutions to easily connect SKF Hydraulic pumps to the application

Quick connecting couplings and nipples

SKF has a range of quick connecting couplings and nipples to connect SKF Hydraulic pumps and their pressure hoses to the application. These are available for different maximum working pressures from 100 MPa to 400 MPa. The pressure hoses, which are attached to the pump, should be provided with a quick connection coupling and on the application side the matching quick connection nipple should be placed.

- Time savings compared to manually threading of various nipples and pipes together
- More freedom for positioning pumps in relation to the application
- Safe and secure connections
- No need for de-airing hoses when connected to pumps
- Different pressure ratings available for all SKF hydraulics pumps

Technical data - Quick connection couplings

Designation	729831 A		THPC 300-1		THPC 400-1	
Thread	d	G ¹ / ₄	M16x1.5		M16x1.5	
Dimensions	AF	Hex 24 (15/16")	22 mm (7/8")	26 mm (1 1/16")	30 mm (1.18 in.)	34 mm (1.34 in.)
	C	28 mm (1.1 in.)	65 mm (2.56 in.)	68 mm (2.67 in.)		
	L	61 mm (2.4 in.)				
Maximum pressure		150 MPa (21 750 psi)	300 MPa (43 500 psi)	400 MPa (58 000 psi)		
Temperature range		-30 to 100 °C (-22 to 212 °F)	-30 to 80 °C (-22 to 176 °F)	-20 to 80 °C (-4 to 176 °F)		
Tightening torque		40 Nm (29.5 ft-lb.)	45 Nm (33.2 ft-lb.)	45 Nm (33.2 ft-lb.)		
Weight		0.15 kg (0.33 lb)	0.189 kg (0.42 lb)	0.343 kg (0.76 lb)		

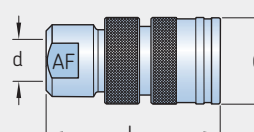
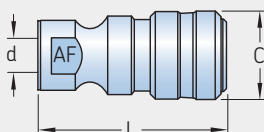

Technical data - Quick connection nipples

Designation	729100		729832 A		THPN 300-1		THPN 400-1	
Thread	d	G ¹ / ₈	G ¹ / ₄		M16x1.5		M16x1.5	
Dimensions	AF	Hex 17 (0.67 in.)	Hex 22 (7/8")	22 mm (7/8")	22 mm (7/8")	25 mm (0.98 in.)	25 mm (0.98 in.)	
	A	20 mm (0.78 in.)	25.4 mm (1.00 in.)	25 mm (0.98 in.)	25 mm (0.98 in.)	55 mm (2.17 in.)	59 mm (2.32 in.)	
	L	43 mm (1.69 in.)	50 mm (1.97 in.)	55 mm (2.17 in.)	59 mm (2.32 in.)			
Maximum pressure		100 MPa (14 500 psi)	150 MPa (21 750 psi)	300 MPa (43 500 psi)	400 MPa (58 000 psi)			
Temperature range		-30 to 100 °C (-22 to 212 °F)	-30 to 100 °C (-22 to 212 °F)	-20 to 80 °C (-4 to 176 °F)	-20 to 80 °C (-4 to 176 °F)			
Tightening torque		40 Nm (29.5 ft-lb.)	40 Nm (29.5 ft-lb.)	45 Nm (33.2 ft-lb.)	45 Nm (33.2 ft-lb.)			
Weight		0.05 kg (0.11 lb)	0.065 kg (0.14 lb)	0.128 kg (0.28 lb)	0.164 kg (0.36 lb)			

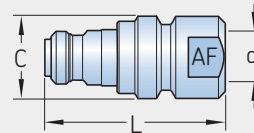
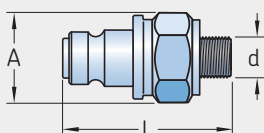

When nipples for other threads are required use SKF connection nipples

Hydraulic tools



Connection nipples

SKF provides a wide range of connection nipples covering many different thread combinations and sizes. They are used as adapters to enable pipes and hoses to be connected to different thread sizes.

- Nipples with metric and G pipe threads
- Nipples with NPT tapered threads
- Nipples for connecting high pressure hoses
- Swivel adapter

Technical data – Connection nipples with pipe (G) and metric thread

Designation	G ₁	G ₂	Max. working pressure		Dimensions						A - Across flats				
			MPa	psi	A		A ₁		L ₁			L ₂		L	
					mm	in.	mm	in.	mm	in.	mm	in.	mm	in.	
1077456/100MPa	M6	M8	100	14 500	11	0.43	5	0.20	9	0.35	15	0.59	33	1.30	10
1077455/100MPa	M6	G ¹ / ₈	100	14 500	11	0.43	7	0.28	9	0.35	15	0.59	33	1.30	10
1014357 A	G ¹ / ₄	G ¹ / ₈	300	43 500	25.4	1.00	7	0.28	15	0.59	15	0.59	43	1.69	22
1009030 B	G ³ / ₈	G ¹ / ₈	300	43 500	25.4	1.00	7	0.28	15	0.59	15	0.59	42	1.65	22
1019950	G ¹ / ₂	G ¹ / ₈	300	43 500	36.9	1.45	7	0.28	14	0.55	15	0.59	50	1.97	32
1018219 E	G ³ / ₈	G ¹ / ₄	400	58 000	25.4	1.00	9.5	0.37	15	0.59	17	0.67	46	1.81	22
1009030 E	G ³ / ₄	G ¹ / ₄	400	58 000	36.9	1.45	9.5	0.37	20	0.79	17	0.67	54	2.13	32
1012783 E	G ¹ / ₄	G ³ / ₈	400	58 000	25.4	1.00	10	0.39	15	0.59	17	0.67	43	1.69	22
1008593 E	G ³ / ₄	G ³ / ₈	400	58 000	36.9	1.45	10	0.39	20	0.79	17	0.67	53	2.09	32
1016402 E	G ¹ / ₄	G ¹ / ₂	400	58 000	25.4	1.00	14	0.55	15	0.59	20	0.79	43	1.69	22
729146	G ³ / ₄	G ¹ / ₂	300	43 500	36.9	1.45	14	0.55	20	0.79	22	0.87	55	2.17	32
228027 E	G ¹ / ₄	G ³ / ₄	400	58 000	36.9	1.45	15	0.59	15	0.59	22	0.87	50	1.97	32
1018220 E ¹⁾	G ¹ / ₄	G ¹ / ₄	400	58 000	25.4	1.00	9.5	0.37	15	0.59	20	0.79	52	2.05	22

¹⁾ Not suitable for use with quick connection couplings and nipples!

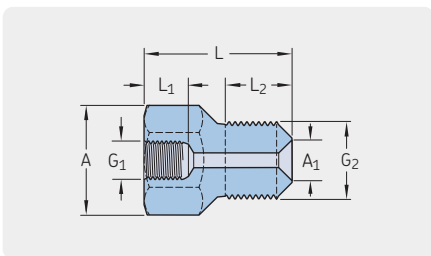

Connection nipples with pipe (G) and metric thread

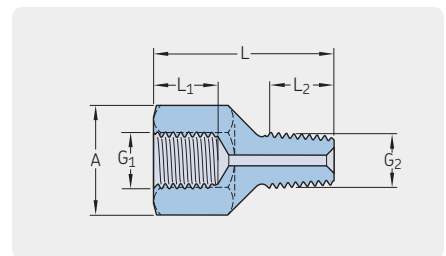

Connection nipples with tapered threads (NPT)

Technical data – Connection nipples with tapered threads (NPT)

Designation	G ₁	G ₂	Max. working pressure		Dimensions						A - across flats		
			MPa	psi	A		L ₁		L ₂			L	
					mm	in.	mm	in.	mm	in.	mm	in.	mm
729106/100MPa	NPT ³ / ₈ "	G ¹ / ₄	100	14 500	36.9	1.45	15	0.59	17	0.67	50	1.97	32
729654/150MPa	G ¹ / ₄	NPT ¹ / ₄ "	150	21 750	25.4	1.00	15	0.59	15	0.59	42	1.65	22
729655/150MPa	G ¹ / ₄	NPT ³ / ₈ "	150	21 750	25.4	1.00	15	0.59	15	0.59	40	1.57	22
729656/150MPa	G ¹ / ₄	NPT ³ / ₄ "	150	21 750	36.9	1.45	15	0.59	20	0.79	45	1.77	32



Technical data – Application connection nipples with M16x1.5 threads

Designation	G ₁		G ₂		Max. working pressure		Tightening torque G ₁		Dimensions				A - Across flats		
	MPa	psi	Nm	ft-lb	A	L ₁	L ₂	L	mm	in.	mm	in.		mm	in.
THPN M16G1/8	M16x1.5	G ¹ / ₈	300	43 500	45	33	25.4	1.0	-	-	15	0.59	60	2.36	Hex 22
THPN M16G1/4	M16x1.5	G ¹ / ₄	400	58 000	45	33	25.4	1.0	-	-	22	0.87	65	2.56	Hex 22
THPN M16G3/8	M16x1.5	G ³ / ₈	400	58 000	45	33	25.4	1.0	-	-	17	0.67	60	2.36	Hex 22
THPN M16G1/2	M16x1.5	G ¹ / ₂	400	58 000	45	33	25.4	1.0	-	-	20	0.79	60	2.36	Hex 22
THPN M16G3/4	M16x1.5	G ³ / ₄	400	58 000	45	33	36.9	1.45	-	-	22	0.87	67	2.64	Hex 32
THPN FM16G3/4	G ³ / ₄	M16x1.5 (f)	400	58 000	130	96	36.9	1.45	22	0.87	-	-	50	1.96	Hex 32

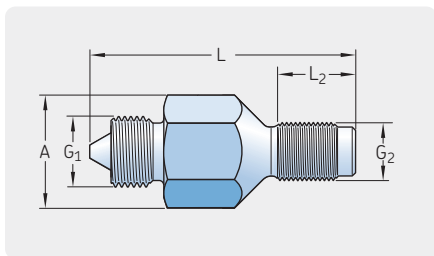

THPN M...

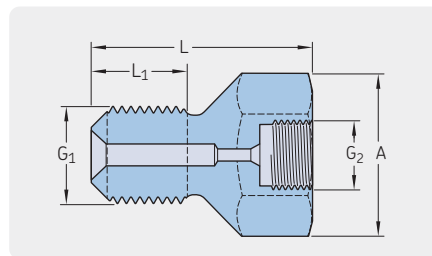

THPN FM...

Technical data – Swivel adapter

Designation	Max. working pressure		Tightening torque G ₁		Tightening torque G ₂		Dimensions														
	MPa	psi	Nm	ft-lb	Nm	ft-lb	G ₁	G ₂	A ₁	A ₂	L ₁	L ₂	L ₃	H	mm	in.	mm	in.	mm	in.	mm
729101-HC1	300	43 500	150	110	50	37	G ³ / ₄	G ¹ / ₄	Hex30	1 ³ / ₁₆	Hex19	³ / ₄	30	1.18	12	0.47	65	2.56	80	3.15	

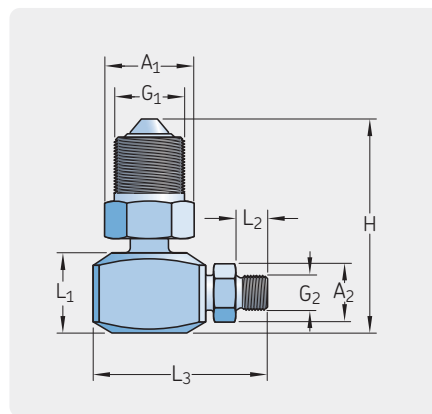

Hydraulic tools

To retrofit high pressure hoses on SKF Oil injectors

Hose conversion kits

Oil injection equipment from SKF is used for mounting and dismounting of pressure joints such as rolling bearings, couplings, gears, flywheels and railway wheel. When the oil injection equipment cannot be connected directly to a pressure joint, a flexible solution is required to connect them. Recently SKF discontinued the high-pressure pipes, and instead offers high-pressure hoses, replacing the high-pressure pipes for the connection of oil injection equipment to pressure joints. The high-pressure pipes were often used in conjunction with SKF oil injectors. To allow a smooth transition, hose conversion kits are offered which enable many of the oil injectors to be retrofitted with a high pressure hose.

The Hose conversion kits are the recommended way of connecting your existing oil injection kits/sets to your application. For that purpose a set of the most common application nipples are included in the hose conversion kits. Additional application connection nipples are available on request.

- For 300 MPa (43 500 psi) applications, the manually operated oil injectors and kits 729101/300MPa, 729101B, THKI 300 and TMJE 300 can be retrofitted with the hose conversion kit 729101-CK1
- The air-driven oil injectors and kits THAP 300E and THAP 300E/SK1 can be retrofitted with the hose conversion kit THAP 300-HK1
- The air-driven oil injectors and kits THAP 400E and THAP 400E/SK1 can be retrofitted with the hose conversion kit THAP 400-HK1

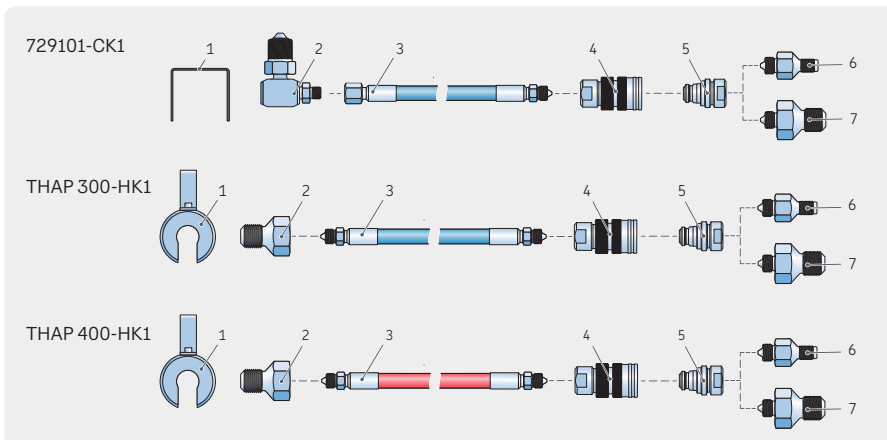

Contents list		729101-CK1	THAP 300-HK1	THAP 400-HK1
Nr.	Description			
1	Protection cover	226402-9	THAP E-PC2	THAP E-PC2
2	Swivel adapter	729101-HC1	–	–
3	Nipple G ³ / ₄ (m), M16x1.5 (f)	–	THPN FM16G3/4	THPN FM16G3/4
3	High pressure hose	THHP 300-2H	THAP 300-H/2	THAP 400-H/2
4	Quick connection coupling	THPC 300-1	THPC 300-1	THPC 400-1
5	Quick connection nipple	THPN 300-1	THPN 300-1	THPN 400-1
6	Nipple M16x1.5 (m), G ¹ / ₄ (m)	THPN M16G1/4	THPN M16G1/4	THPN M16G1/4
7	Nipple M16x1.5 (m), G ³ / ₄ (m)	THPN M16G3/4	THPN M16G3/4	THPN M16G3/4

Technical data for the individual parts can be found on pages 72, 73 and 75



Catering for adapter and withdrawal sleeve applications

Extension pipes

M4 extension pipe with connection nipple
Enables the use of an SKF hydraulic pump to connect to a sleeve connection hole with a M4 thread. The extension pipe and connection nipple should be ordered as separate items.

M6 extension pipe with connection nipple
Enables the use of an SKF hydraulic pump to connect to a sleeve connection hole with a M6 thread. The extension pipe and connection nipple should be ordered as separate items.

G^{1/4} extension pipe
Enables the use of an SKF hydraulic pump to connect to a sleeve connection hole with a G^{1/4} thread. Can be used for applications where the sleeve position does not allow a direct connection with a quick connector.

G^{1/8} extension pipe
Enables the use of an SKF hydraulic pump to connect to a sleeve connection hole with a G^{1/8} thread. Can be used for applications where the sleeve position does not allow a direct connection with a quick connector.

Technical data			
Designation	Max. pressure		
pipe 234064/50MPa	50 MPa (7 250 psi)		M4 extension pipe with connection nipple
nipple 234063/50MPa	50 MPa (7 250 psi)		
pipe 1077453/100MPa	100 MPa (14 500 psi)		M6 extension pipe with connection nipple
nipple 1077454/100MPa	100 MPa (14 500 psi)		
pipe 227966/100MPa	100 MPa (14 500 psi)		G ^{1/4} extension pipe
pipe 227965/100MPa	100 MPa (14 500 psi)		
			G ^{1/8} extension pipe



Up to 400 MPa (58 000 psi)

Plugs for oil ducts and vent holes

SKF plugs have been designed to seal off oil connections at a maximum pressure of 400 MPa (58 000 psi).

Technical data						
Designation	Thread	Length				
233950 E	G ^{1/4}	15 mm (0.59 in.)		Plug 233950 E	Plug 729944 E	Plug 1030816 E
729944 E	G ^{1/2}	17 mm (0.67 in.)				
1030816 E	G ^{3/4}	23 mm (0.90 in.)				
Maximum working pressure 400 MPa (58 000 psi)						

Hydraulic tools

High pressure rigid pipes for hose connection in limited spaces

Pre-bent pipes

The SKF range of oil injection products mainly connects to the application(s) using high-pressure hoses and nipples. However, some applications can still be difficult to connect to, mainly due to access or size. Therefore, we have introduced a versatile solution of a range of rigid pipes and connection nipples, the THPA series. This product range is an extension to the high-pressure hoses to connect to the application.

- To be used in applications where the high pressure hoses, the quick connection couplings and the connection nipples require too much space
- To be used in combination with quick connection couplings and high pressure pipes
- Pre-bent pipes are available in a 90°, a 135° and a 125° execution
- Nipples are available for applications with G1/8, G1/4, or G3/4 threads
- Maximum working pressure for the complete THPA range: 400 MPa (58 000 psi), except for the G1/8 nipple: 300 MPa (43 500 psi)



Part identification		
Designation	Description	Max working pressure
THPA M12	Rigid pipe for hose connection, L shape 90° with 2xM12 female cone connection	400 MPa (58,000psi)
THPA M12/B	Rigid pipe for hose connection, L shape 135° with 2xM12 female cone connection	400 MPa (58,000psi)
THPA M12/C	Rigid pipe for hose connection, L shape 125° with 2xM12 female cone connection	400 MPa (58,000psi)
THPA M12/D	Rigid pipe for hose connection, straight with 2xM12 female cone connection	400 MPa (58,000psi)
THPA AM12/G1/8	Nipple with M12 cone, application side G1/8 spherical end	300 MPa (43,500psi)
THPA AM12/G1/4	Nipple with M12 cone, application side G1/4 spherical end	400 MPa (58,000psi)
THPA AM12/G3/4	Nipple with M12 cone, application side G3/4 spherical end	400 MPa (58,000psi)
THPA AM12/M16	Nipple with M12 cone, application side M16 male cone	400 MPa (58,000psi)

Technical data - Pipes

Designation		THPA M12	THPA M12/B	THPA M12/C	THPA M12/D
Dimensions	L ₁	34 mm (1.34 in.)	25 mm (0.98 in.)	25 mm (0.98 in.)	-
	L ₂	165 mm (6.50 in.)	166 mm (6.54 in.)	166 mm (6.54 in.)	187 mm (6.54 in.)
	A	HEX 12 mm (0.47 in.)	HEX 12 mm (0.47 in.)	HEX 12 mm (0.47 in.)	HEX 12 mm (0.47 in.)
	G ₁	M12	M12	M12	M12
	K	16 mm (0.63 in.)	16 mm (0.63 in.)	16 mm (0.63 in.)	16 mm (0.63 in.)
	α	90 deg.	135 deg.	125 deg.	-
Tightening torque	G ₂	30 Nm (22 ft-lb)	30 Nm (22 ft-lb)	30 Nm (22 ft-lb)	30 Nm (22 ft-lb)
Weight		0.07 kg (0.15 lb)	0.07 kg (0.15 lb)	0.07 kg (0.15 lb)	0.07 kg (0.15 lb)

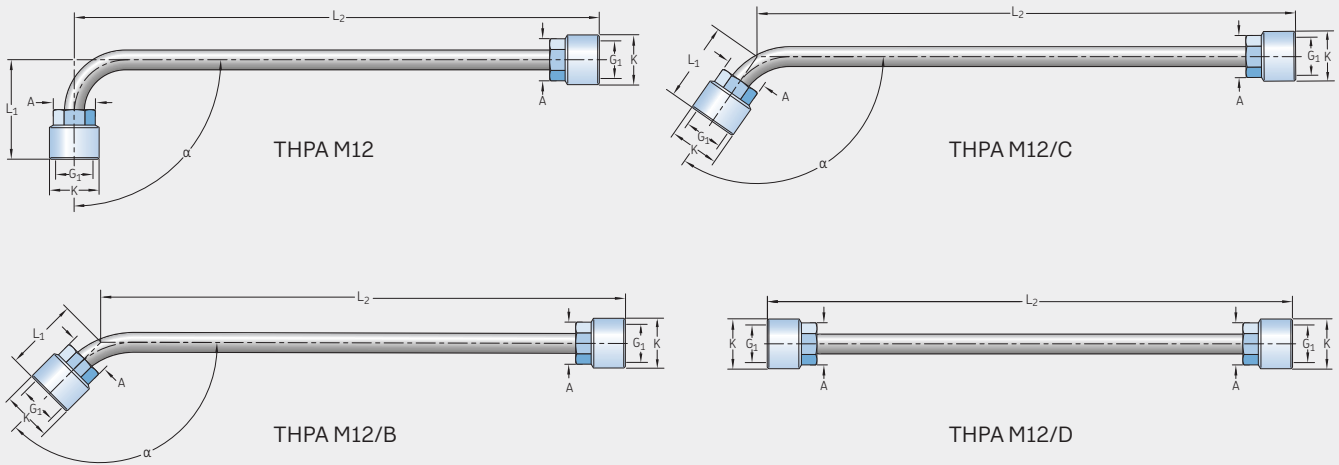

Technical data - Nipples

Designation		THPA AM12/G1/8	THPA AM12/G1/4	THPA AM12/G3/4	THPA AM12/M16
Dimensions	G ₁	M12 (m)	M12 (m)	M12 (m)	M12 (m)
	G ₂	G1/8 (m)	G1/4 (m)	G3/4 (m)	M16
	Max. pressure	300 MPa (43 500 psi)	400 MPa (58 000 psi)	400 MPa (58 000 psi)	400 MPa (58 000 psi)
	A	HEX 12	HEX 13	HEX 17	HEX 22
	L ₂	20.5 mm (0.81 in.)	22 mm (0.87 in.)	23.5 mm (0.94 in.)	-
	L	35 mm (1.38 in.)	36.5 mm (1.44 in.)	40 mm (1.57 in.)	55 mm (2.17 in.)
Tightening torque	G ₁	30 Nm (22 ft-lb)	30 Nm (22 ft-lb)	30 Nm (22 ft-lb)	30 Nm (22 ft-lb)
	G ₂	-	-	-	45 Nm (33 ft-lb.)
Weight		0.02 (0.04 lb)	0.03 (0.07 lb)	0.090 kg (0.20 lb)	0.10 kg (0.24 lb)

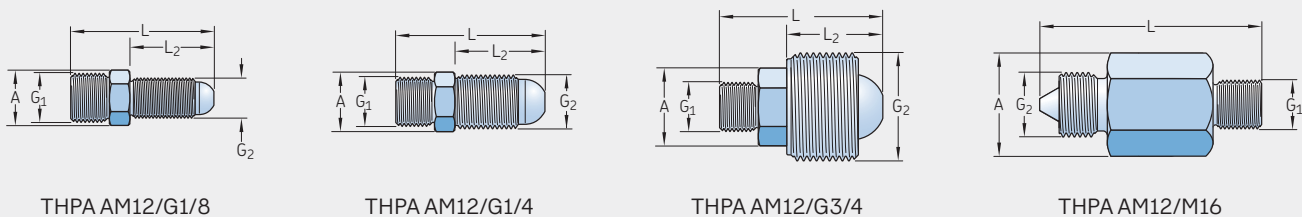

Hydraulic tools



For accurate bearing clearance measurement

Feeler gauges 729865 series

As an alternative to the SKF Drive-up method Feeler gauges can be used to measure the internal clearance when adjusting spherical roller bearings. Two types are available, one with 13 blades of 100 mm (4 in.) length and the other with 29 blades of 200 mm (8 in.) length.

- Highly accurate measurement
- Supplied with protective plastic cover
- Supplied with protective steel cage

Designation	Blade length		Blade thickness					
	mm	in.	mm	in.	mm	in.	mm	in.
729865 A	100	4.0	0.03	0.0012	0.08	0.0031	0.14	0.0055
			0.04	0.0016	0.09	0.0035	0.15	0.0059
			0.05	0.002	0.10	0.0039	0.20	0.0079
			0.06	0.0024	0.12	0.0047	0.30	0.0118
			0.07	0.0028				
729865 B	200	8.0	0.05	0.002	0.18	0.0071	0.60	0.0236
			0.09	0.0035	0.19	0.0075	0.65	0.0256
			0.10	0.0039	0.20	0.0079	0.70	0.0276
			0.11	0.0043	0.25	0.0098	0.75	0.0295
			0.12	0.0047	0.30	0.0118	0.80	0.0315
			0.13	0.0051	0.35	0.0138	0.85	0.0335
			0.14	0.0055	0.40	0.0157	0.90	0.0354
			0.15	0.0059	0.45	0.0177	0.95	0.0374
			0.16	0.0063	0.50	0.0197	1.00	0.0394
			0.17	0.0067	0.55	0.0216		



For bearing mounting

Mounting fluid LHM 300

SKF Mounting Fluid is suitable for use with SKF hydraulic equipment, including hydraulic pumps, HMV ..E nuts and oil injection tools. SKF LHM 300 contains anti-corrosives which are non-aggressive to seal materials such as nitrile rubber, perbunan, leather and chrome leather, PTFE, and so on.



Technical data

Designation	LHM 300/pack size
Colour	Amber
Specific gravity	0.882
Flash point	200 °C (390 °F)
Pour point	-30 °C (-22 °F)
Viscosity at 20 °C (68 °F)	307 mm ² /s
Viscosity at 40 °C (104 °F)	116 mm ² /s
Viscosity at 100 °C (212 °F)	17.5 mm ² /s
Viscosity index	167
Rust test ASTM D665 A/B	Pass
Cleanliness	ISO 4406:2021 18/17/13
Shelf life	5 years
Available pack size	1, 5, 205 litre

These characteristics represent typical values.

For bearing dismounting

Dismounting fluid LHDF 900

SKF Dismounting Fluid is suitable for use with SKF hydraulic equipment, including hydraulic pumps and oil injection tools. SKF LHDF 900 contains anti-corrosives which are non-aggressive to seal materials such as nitrile rubber, perbunan, leather and chrome leather, PTFE, and so on.



Technical data

Designation	LHDF 900/pack size
Colour	Amber
Specific gravity	0.885
Flash point	202 °C (395 °F)
Pour point	-28 °C (-18 °F)
Viscosity at 20 °C (68 °F)	910 mm ² /s
Viscosity at 40 °C (104 °F)	330 mm ² /s
Viscosity at 100 °C (212 °F)	43 mm ² /s
Viscosity index	187
Rust test ASTM D665 A/B	Pass
Cleanliness	ISO 4406:2021 18/17/13
Shelf life	5 years
Available pack size	5 and 205 litre

These characteristics represent typical values.

OK Coupling mounting and dismounting kits

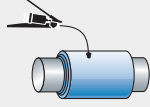
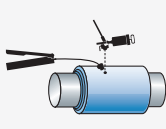
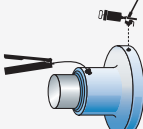
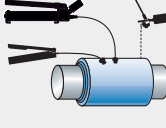
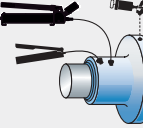
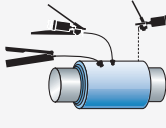
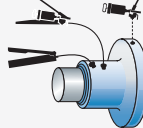
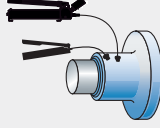
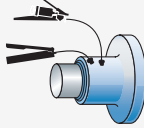
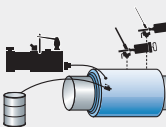
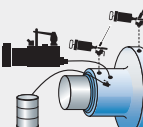
Technical data				
Coupling size	Designation	Contents	Weight	Application
OKC 045 - OKC090	TMHK 35	1 × 226400 E Injector with spares 1 × 226402 Adapter block 1 × 729101-CK Hose conversion kit 1 × TMHK 1-K Hex keys 1/4, 3/8, 9/16, 3, 4, 6, 8 mm Tools and storage case	14.1 kg (31.2 lb)	 <p>OKC</p>
OKC 100–OKC 170 OKCS 178–OKCS 360 OKCX 100–OKCX 170 OKFX <250 with one high pressure injector OKCYX 100–200 ¹⁾	TMHK 36	1 × 226400 E Injector with spares 1 × TMJL 50 Hydraulic pump 1 × TMHK 1-K Hex keys 1/4, 3/8, 9/16, 3, 4, 6, 8 mm Tools and storage case ¹⁾ 1 × 729100 needs to be ordered separately	19 kg (41.8 lb)	 <p>OKC, OKCX</p>  <p>OKFX</p>
OKC 180–OKC 250 OKF 100–OKF 300 OKCX 180–OKC 250 OKFX <250 with two high pressure injectors Shipyard or frequent use	TMHK 37S	1 × 226400 E Injector with spares 1 × THHP 300 Hydraulic pump 1 × TMJL 50 Hydraulic pump 1 × TMHK 1-K Hex keys 1/4, 3/8, 9/16, 3, 4, 6, 8 mm Tools and storage case	47,1 kg (104 lb)	 <p>OKC, OKCX</p>  <p>OKF, OKFX</p>
OKC 180–OKC 250 OKF 100–OKF 300 OKCX 180–OKCX 250 OKFX <250 with two high pressure injectors Shipboard or infrequent use	TMHK 37E	2 × 226400 E Injector with spares 1 × 226402 ²⁾ Adapter block 1 × 729101-CK1 ¹⁾ Pressure hose conversion kit 1 × TMJL 50 Hydraulic pump 1 × TMHK 1-K Hex keys 1/4, 3/8, 9/16, 3, 4, 6, 8 mm Tools and storage cases ²⁾ for use with OKF couplings	28,1 kg (61.8 lb)	 <p>OKC, OKCX</p>  <p>OKF, OKFX</p>
OKFX <250 with one high pressure injector Shipyard or frequent use	TMHK 37T	1 × THHP 300 Hydraulic pump 1 × TMJL 50 Hydraulic pump 1 × TMHK 1-K Hex keys 1/4, 3/8, 9/16, 3, 4, 6, 8 mm 2 × Tools and storage cases	45 kg (99.2 lb)	 <p>OKFX</p>
OKFX <250 with one high pressure injector Shipboard or infrequent use	TMHK 37F	1 × 226400 E Injector with spares 1 × 226402 Adapter block 1 × 729101-CK1 Pressure hose conversion kit 1 × TMJL 50 Hydraulic pump 1 × TMHK 1-K Hex keys 1/4, 3/8, 9/16, 3, 4, 6, 8 mm Tools and storage case	25.4 kg (56 lb)	 <p>OKFX</p>
OKC 180–OKC 490 OKF 300–OKF 700 OKCX 180–OKCX 490 OKFX >250 with two high pressure injectors Shipboard or infrequent use	TMHK 38	1 × THAP 030E/SK1 Air-driven pump set 1 × 729147A Return hose 2 × 226400 E Injector with spares 1 × TMHK 1-K Hex keys 1/4, 3/8, 9/16, 3, 4, 6, 8 mm Tools and storage case	36 kg (79.5 lb)	 <p>OKC, OKCX</p>  <p>OKF, OKFX</p>

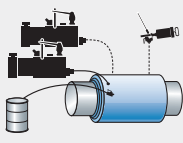
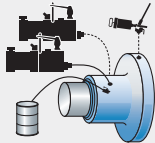
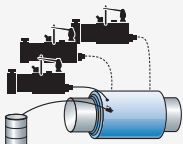
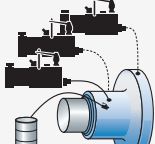
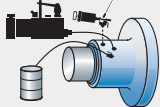
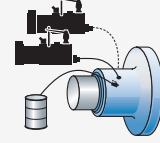
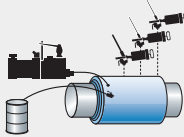
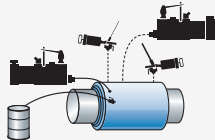
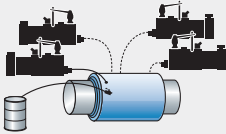
Technical data					
Coupling size	Designation	Contents	Weight	Application	
OKC 180–OKC 490 OKF 300–OKF 700 OKCX 180–OKCX490 OKFX >250 with two high pressure injector	TMHK 38S	1 × THAP 030E/SK1 Air-driven pump set 1 × 729147A Return hose 1 × THAP 300E Air-driven oil injector 1 × 226400 E Injector with spares 1 × TMHK 1-K Hex keys 1/4, 3/8, 9/16, 3, 4, 6, 8 mm Tools and storage cases	81.7 kg (180 lb)		
Shipyard or frequent use				OKC, OKCX	OKF, OKFX
OKC 180–OKC 490 OKF 300–OKF 700 OKCX 180–OKCX490 OKFX >250 with two high pressure injectors	TMHK 38R	1 × THAP 030E/SK1 Air-driven pump 2 × THAP 300 E air driven oil injector 1 × 729147A Return hose 1 × TMHK 1-K Hex keys 1/4,3/8, 9/16, 3, 4, 6, 8 mm Tools and storage cases <i>Because of limited space, for OKF and OKFX couplings you might need an extra hose set THAP 300-HK1</i>	102 kg (224 lb)		
Shipyard or frequent use				OKC, OKCX	OKF, OKFX
OKFX >250 with one high pressure injector	TMHK 38F	1 × THAP 030E/SK1 Air-driven pump 1 × 729147A Return hose 1 × 226400 E Injector with spares 1 × TMHK 1-K Hex keys 1/4,3/8, 9/16, 3, 4, 6, 8 mm Tools and storage case	33 kg (73 lb)		
Shipboard or infrequent use				OKFX	
OKFX >250 with one high pressure injector	TMHK 38T	1 × THAP 030E/SK1 Air-driven pump 1 × 729147A Return hose 1 × THAP 300E Air-driven oil injector 1 × TMHK 1-K Hex keys 1/4, 3/8, 9/16, 3, 4, 6, 8 mm 2 × Tools and storage case	76.4 kg (168 lb)		
Shipyard or frequent use				OKFX	
OKC 500–OKC 600 OKCX >500	TMHK 39	1 × THAP 030E/SK1 Air-driven pump 1 × 729147A Return hose 3 × 226400 E Injector with spares 1 × TMHK 1-K Hex keys 1/4, 3/8, 9/16, 3, 4, 6, 8 mm Tools and storage case	38.6 kg (85 lb)		
Shipboard or infrequent use				OKC, OKCX	
OKC 500 and larger OKCX >500	TMHK 40	1 × THAP 030E/SK1 Air-driven pump 1 × THAP 300E Air-driven oil injector 1 × 729147A Return hose 2 × 226400 E Injector with spares 1 × TMHK 1-K Hex keys 1/4, 3/8, 9/16, 3, 4, 6, 8 mm Tools and storage cases	84 kg (185 lb)		
Shipboard or infrequent use				OKC, OKCX	
OKC 500 and larger OKCX >500	TMHK 41	1 × THAP 030E/SK1 Air-driven pump 3 × THAP 300E Air-driven oil injector 1 × 729147A Return hose 1 × TMHK 1-K Hex keys 1/4, 3/8, 9/16, 3, 4, 6, 8 mm Tools and storage cases	136 kg (300 lb)		
Shipyard or frequent use				OKC, OKCX	



Accurate shaft alignment reduces machinery breakdowns and increases your uptime.



Instruments

Alignment86
 Basic condition monitoring 108

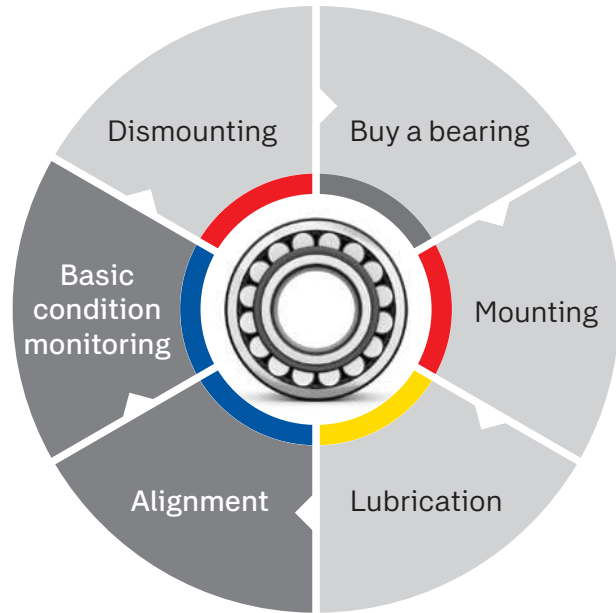

Alignment

Introduction86
 Shaft Alignment tool TKSA 31.89
 Shaft alignment tool TKSA 41.90
 Shaft alignment tool TKSA 51.91
 Shaft alignment tool TKSA 71.92
 Accessories95
 Machinery shims TMAS series98
 SKF Vibracon adjustable chocks100
 Spherical washers102
 Belt alignment tool TKBA 11.104
 Belt alignment tool TKBA 21.104
 Belt alignment tool TKBA 31.105
 Belt alignment tool TKBA 40106

Basic condition monitoring

Introduction108
 Thermometer TKDT 10111
 Infrared thermometer TKTL 11112
 Infrared thermometer TKTL 21112
 Infrared thermometer TKTL 31112
 Infrared thermometer TKTL 40113
 K-type thermocouple probes TMDT 2 series115
 Tachometer TKRT 10116
 Tachometer TKRT 21116
 Tachometer TKRT 31116
 Ultrasonic leak detector TKSU 10119
 Stroboscope TKRS 11.120
 Stroboscope TKRS 21120
 Stroboscope TKRS 31120
 Stroboscope TKRS 41120
 Electronic stethoscope TKST 11122
 Electronic stethoscope TKST 21122
 Endoscope TKES 10F.124
 Endoscope TKES 10S.124
 Endoscope TKES 10A.124
 Electrical discharge detector pen TKED 1.126
 SKF QuickCollect sensor127

Alignment



Accurate shaft alignment really matters

Reduce machinery breakdowns and increase your uptime

It's a fact. Shaft misalignment is a major contributor to rotating machinery breakdowns. Accurately aligning shafts can prevent a large number of machinery breakdowns and reduce unplanned downtime that results in a loss of production. In today's challenging environment of reducing costs and optimising assets, the necessity of accurate shaft alignment is now greater than ever.

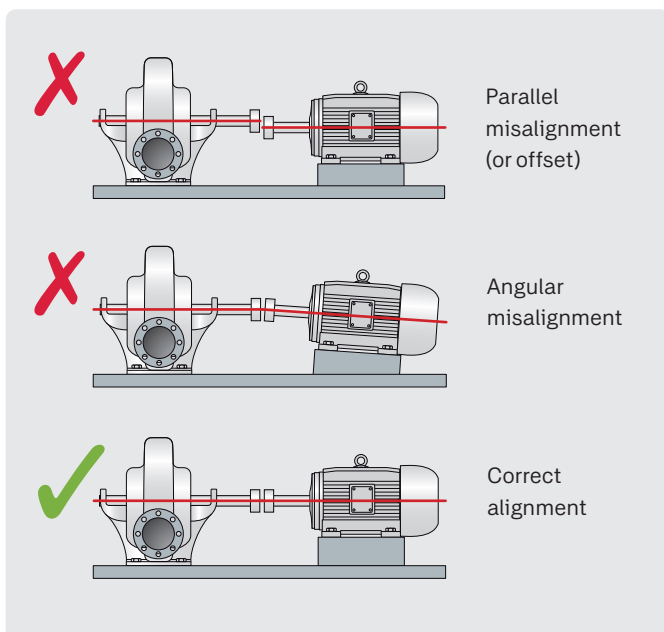

What is shaft misalignment?

Machines need to be aligned in both the horizontal and vertical plane.

The misalignment can be caused by both parallel or angular misalignment. The possible consequences of shaft misalignment are serious to any company's bottom line and include:

- Increased friction and thereby energy consumption
- Premature bearing and seal failure
- Premature shaft and coupling failure
- Excessive seal lubricant leakage
- Failure of coupling and foundation bolts
- Increased vibration and noise



What methods can be used to align shafts?

In general, it's clear that laser alignment systems are quicker and easier to use than dial indicators, have better accuracy and don't require special skills to get accurate results virtually every time.

Which type of laser alignment system should be considered?

Before purchasing a system, identify the applications where it is to be used and make a list of requirements. Buying an expensive system that can accommodate virtually every need can be a costly mistake, as the technicians need to be skilled in using it.

The majority of alignment tasks consist of such things as a horizontally placed electric motor with a pump or fan with a single coupling. For such tasks, the technician needs a system that is quick and easy to use and doesn't need a long set up time.

What can SKF offer?

SKF has developed, after extensive consultation with users, a range of affordable, easy to use shaft alignment tools that are suitable for a majority of alignment tasks.

	Straight edge	Dial indicators	Laser shaft alignment
Accuracy	--	++	++
Speed	++	--	++
Ease of use	++	--	++

Alignment

New technology makes shaft alignment easier and more affordable

Shaft alignment tool TKSA 11



The SKF TKSA 11 is an innovative shaft alignment tool that uses smartphones and tablets and intuitively guides the user through the shaft alignment process. With a focus on the core alignment tasks, the TKSA 11 is designed to be a very easy-to-use instrument that is especially suitable for alignment learners and compact applications. The SKF TKSA 11 is the first instrument on the market that uses inductive proximity sensors, enabling accurate and reliable shaft alignment to be affordable for every budget.

- Live view of the instrument and motor position makes the measurement and horizontal alignment intuitive and easy.
- The TKSA 11 app offers a fully functional demonstration mode allowing the complete alignment process to be experienced without the need to purchase the TKSA 11.
- The TKSA 11 is designed to give a fast return on its investment and is also affordable for almost every budget.
- By using inductive proximity sensors, the measurement is no longer affected by bright sunlight, the influence of backlash is reduced and the instrument becomes more robust. All enabling the TKSA 11 to deliver accurate and reliable shaft alignments.
- Automatic alignment reports give a complete overview of the alignment process and results. Reports can easily be shared via email or cloud services.



The intuitive and affordable laser shaft alignment system

Shaft Alignment tool TKSA 31

The TKSA 31 is SKF's most affordable solution for easy laser shaft alignment. The ergonomic display unit with touch screen makes the instrument very easy to use and the built-in machine library helps storing alignment reports for multiple machines. Large sized laser detectors in the measuring heads reduce the need for pre-alignments and the embedded soft foot tool helps establish the foundation for a successful alignment. Additional functions such as live view and automatic measurement support fast and effective alignment tasks and make the TKSA 31 an innovative laser shaft alignment tool that is affordable for almost every budget.

- Easy measurements can be performed by using the well-known three position measurement (9-12-3 o'clock) with additional positioning flexibility of 40° around each measurement position.
- High affordability is achieved by focussing on the standard shaft alignment process and essential functions to allow quick and effective shaft alignments.
- "Automatic measurement" enables hands-free measurements by detecting the position of the heads and only taking a measurement when the heads are in the right position.
- Automatic reports are generated after each alignment and can be customised with notes about the application. All reports can be exported as pdf files.
- The machine library gives an overview of all machines and alignment reports. It simplifies the machine identification and improves the alignment workflow.



Live view supports intuitive measurements and facilitates horizontal and vertical machine position corrections.



Alignment

The advanced laser shaft alignment system with enhanced measuring and reporting capabilities

Shaft alignment tool TKSA 41



Free measurement allows alignment measurements to start at any angle and finish with an angular sweep of just 90°.



Machine library gives an overview of all machines and alignment reports.

The TKSA 41 is an advanced laser alignment solution for achieving accurate shaft alignments. With two wireless measurement units, large sized detectors and powerful lasers, the instrument performs precise measurements in even the most challenging conditions. The ergonomic display unit with intuitive touch screen navigation makes your alignments fast and easy, whilst innovative features, like the “free measurement”, increase the alignment performance. With the focus on improving alignment practices, the SKF Shaft Alignment Tool, TKSA 41, is one of the industry’s best value alignment solutions.

- Wireless communication improves instrument handling and allows alignments of difficult to reach applications from a safe position.
- Automatic measurement enables hands-free measurements by detecting the head position and taking a measurement when the heads are rotated into the right position.
- Automatic reports are generated after each alignment. The reports can be customised with notes and pictures from the built-in camera for the most comprehensive overview. All reports can be exported as pdf files.
- Live view supports intuitive measurements and facilitates horizontal and vertical alignments.
- The simplicity of the TKSA 41 provides greater confidence for the performance of alignment tasks on all types of horizontal rotating machines.
- QR codes can be used to further simplify machine identification and improve the alignment workflow.

Comprehensive and intuitive shaft alignment utilising tablets and smart phones

Shaft alignment tool TKSA 51



The TKSA 51 shaft alignment tool provides high measurement flexibility and performance suitable for entry-level to expert alignment jobs. Designed to work with the SKF shaft alignment apps on a tablet or smart phone, this intuitive tool is easy to use and requires no special training. The included accessories enable use of the TKSA 51 for a wide range of alignment applications with horizontal and vertical shafts, such as motors, drives, fans, pumps, gearboxes and more. The apps include tutorial videos to show operators how to perform accurate measurements.

- **Measurement flexibility** - The well-known, three-position measurement gains additional flexibility as measurements can start at any angle and require a total minimal rotation of only 40 degrees. This enables operators to perform alignments of applications with limited space.
- **Automatic reports** - Alignment reports are generated automatically and can be customised with notes, a machine picture and a signature via touchscreen. The reports can be easily exported as PDF files and shared with other mobile apps.
- **Comprehensive and compact** - A range of included components, such as magnetic mounting brackets and extension rods and chains, increase the TKSA 51's versatility, yet it remains compact, lightweight and easy to carry.
- **3-D live view** - This feature enables intuitive positioning of the heads for quick alignment measurements and displays the horizontal and vertical alignment correction live. The apps enable 3-D rotation of the virtual motor to correspond with the actual machine position view.
- **Disturbance compensation** - Measurement values are averaged over time to provide greater accuracy in presence of external disturbances.

Alignment applications

The TKSA 51 uses dedicated apps for alignments of horizontal and vertical shaft and the correction of soft foot. The apps are icon-driven and very easy to use. All apps are free of charge and features a fully functional demonstration mode that allows the alignment process to be experienced before purchasing the instrument.



Shaft alignment



Vertical shaft alignment



Soft foot

Alignment

Versatility and performance for professional alignment

Shaft alignment tool TKSA 71



TKSA 71 delivers precision and durability

Designed for professional alignment in harsh industrial environments, the TKSA 71 complements SKF's offering with a high-end shaft alignment tool. The instrument is very versatile with ultra-compact measuring units for use in extremely narrow spaces. Its dedicated software applications enable different types of alignments, including horizontal and vertical shafts, spacer shafts and machine trains.

Superior alignment performance and long-term industrial durability are achieved with an innovative instrument design that offers high measurement accuracy and excellent protection against dust and water in harsh environments.

- **Easy-to-use** - Intuitive software applications, guided alignment processes and explanatory videos
- **Wide range of applications** - Comprehensive accessories and dedicated software applications
- **Superior alignment performance** - Up to 10 m measurement distance, disturbance compensation, measurement flexibility, only 40° total rotation, automatic measurement and customised alignments with target values
- **Protection against harsh environments** - Completely sealed measuring units (IP67) to withstand dust and water
- **Ultra-compact measuring units** - Use in extremely narrow spaces
- **Robust carrying case** - Excellent protection, convenient transport and wireless in-case charging

Complete system for your alignment needs

The TKSA 71 base model includes standard accessories for most alignment tasks. It is supplied in a rugged case that meets most airline requirements for cabin luggage.

The TKSA 71/PRO model includes additional accessories such as sliding brackets, magnetic bases and offset brackets that are useful for more demanding alignment jobs. This model is supplied in a larger, rugged trolley case.

Measuring device: (1) Measuring units (M & S) with standard V-bracket, (2) Wireless charging pods with USB cable, (3) Tape measure

Standard accessories: (4) Extension chains, (5) Extension rods, (6) Mounting magnets

Advanced accessories: (7) Sliding brackets, (8) Offset brackets, (9) Additional extension rods, (10) Magnetic bases



Alignment applications

The TKSA 71 functions quickly and intuitively using six software apps tailored for different alignment jobs. Designed for use without prior training, these simple-to-use apps are available free of charge for both Android and iOS platforms. Common features include comprehensive, automatic reports, export and sharing options, machine library with QR code identification, instructional videos within the app, built-in tolerance guidelines, 3-D live view, disturbance compensation and a fully functional demonstration mode.



Shaft alignment

Easy and intuitive alignments of horizontal shafts with additional features including automatic measurement, minimal 40° total rotation, 9-12-3 guidance and alignment customisation with target values¹⁾.



Soft foot

Assists technician in verifying that machine is standing evenly on all four feet. The app supports the operator identifying and correcting a soft foot¹⁾.



Vertical shaft alignment

Easy and intuitive alignment of vertical shaft machines with shimming support for different bolt configurations¹⁾.



Spacer shaft alignment

Accommodates special requirements of spacer shafts and facilitates the alignment process²⁾.



Machine train shaft alignment

Enables operator to align three connected machines, giving a complete overview of machine train alignment and allowing the operator to select stationary feet²⁾.



Values

Allows the shaft alignment tool to be used as digital dial gauges; operators can record absolute, zeroed and halved readings to perform customised alignments with manual calculations²⁾.

¹⁾Compatible with: TKSA 51, TKSA 71, TKSA 71/PRO. ²⁾Compatible with: TKSA 71, TKSA 71/PRO.



TKSA 71

TKSA 71/PRO



Alignment

Selection chart	TKSA 11	TKSA 31	TKSA 41	TKSA 51	TKSA 71	TKSA 71/PRO
User interface Type of display device	phone, tablet (iOS & Android)	touch screen display device	touch screen display device	phone, tablet (iOS & Android)	phone, tablet (iOS & Android)	phone, tablet (iOS & Android)
Display device included	no	yes	yes	no	no	no
Measurement positions The "9-12-3" measurement directs the user to three pre-defined measurement positions. The "free" measurement allows the user to freely select the measurement positions. All measurements are guided.	9-12-3	9-12-3	free	free	free	free
Wireless measuring heads	•	-	•	•	•	•
Measurement distance Maximum possible distance between the brackets of the measuring heads.	18,5 cm	2 m ¹⁾	4 m	5 m	10 m	10 m
Minimal shaft rotation Describes the minimal required total shaft rotation angle to perform alignment measurements.	180°	140°	90°	40°	40°	40°
Camera Machine picture(s) can be taken and added to alignment reports.	•	-	•	•	•	•
Machine library Overview of all registered machines and previous alignment reports.	-	•	•	•	•	•
QR code recognition QR labels can be used to simplify the machine identification and increase the usage convenience.	-	-	•	•	•	•
Machine view The machine view describes how the machine is shown on the display. The free 3D rotation allows to view the machine from all directions.	fixed 2D view	fixed 3D view	fixed 3D view	free 3D rotation	free 3D rotation	free 3D rotation
Target values Using target values for alignment, it is possible to compensate for thermal expansion or similar adjustments.	-	-	-	•	•	•
Disturbance compensation Measurement values are averaged over time, allowing accurate measurements in the presence of laser distortions from air temperature gradients or similar disturbances.	-	-	-	•	•	•

Supported alignment applications	TKSA 11	TKSA 31	TKSA 41	TKSA 51	TKSA 71	TKSA 71/PRO
Horizontal shaft alignment	•	•	•	•	•	•
Soft foot correction	-	•	•	•	•	•
Vertical shaft alignment	-	-	-	•	•	•
Spacer shaft	-	-	-	-	•	•
Machine train	-	-	-	-	•	•
Digital dial gauge mode	-	-	-	-	•	•

Alignment accessories	TKSA 11	TKSA 31	TKSA 41	TKSA 51	TKSA 71	TKSA 71/PRO
Extension chains	optional	optional	optional	optional	included	included
Extension rods	optional	optional	included	included	included	included
Magnetic V-brackets	optional	optional	optional	included	included	included
Offset brackets	optional	optional	optional	optional	optional	included
Sliding brackets	optional	optional	optional	optional	optional	included
Magnetic base	-	optional	optional	optional	optional	included
Spindle bracket	optional	-	-	optional	optional	optional

¹⁾ With supplied USB cables

Accessories

Accessories Ordering designations	Content and description	Compatible				
		TKSA 11	TKSA 31	TKSA 41	TKSA 51	TKSA71(/PRO)
Extension chains						
TKSA 41-EXTCH	2 × Extension chains of 500 mm (19.7 in.) for shaft diameters up to 300 mm (11.8 in.)	-	●	●	-	-
TKSA 51-EXTCH	2 × Extension chains of 1 m (3.3 ft.) for shaft diameters up to 450 mm (17.7 in.)	●	-	-	●	●
Rods						
TKSA ROD90	4 × threaded rods of 90 mm (3.5 in.)	-	●	●	-	-
TKSA ROD150	4 × threaded rods of 150 mm (5.9 in.)	-	●	●	-	-
TKSA 51-ROD80	4 × threaded rods of 80 mm (3.1 in.)	●	-	-	●	●
TKSA 51-ROD120	4 × threaded rods of 120 mm (4.7 in.)	●	-	-	●	●
Magnetic V-brackets						
TKSA MAGVBK	2 × Magnetic V-brackets, supplied without rods or chains	-	●	●	-	-
TKSA 51-VBK	1 × Standard V-bracket, supplied with 2 × threaded rods of 80 mm (3.2 in.), 1 × standard chain of 480 mm (18.9 in.) and 4 × magnets	●	-	-	●	●
Spindle brackets Rods						
TKSA 51-SPDBK	1 × Spindle bracket, supplied with 2 × threaded rods of 80 mm (3.2 in.)	●	-	-	●	●
Sliding brackets						
TKSA 51-SLDBK	1 × Adjustable sliding bracket for use with shaft diameters >30 mm (1.2 in.) or bore diameters >120 mm (4.7 in.), supplied without rods	●	-	-	●	●
TKSA SLDBK	2 × Wheels to be used with standard V-Bracket (TKSA VBK), supplied without V-bracket	-	●	●	-	-
Offset brackets						
TKSA EXT50	2 × Offset brackets of 50 mm (2 in.) compatible with standard (TKSA VBK) and magnetic V-brackets (TKSA MAGVBK) and magnetic base (TKSA MAGBASE)	-	●	●	-	-
TKSA EXT100	2 × Offset brackets of 100 mm (3.9 in.) compatible with standard (TKSA VBK) and magnetic V-brackets (TKSA MAGVBK) and magnetic base (TKSA MAGBASE)	-	●	●	-	-
TKSA 51-EXT50	1 × Offset bracket 50 mm (2 in.), supplied with 2 × rods 80 mm (3.2 in.)	●	-	-	●	●
Magnetic base						
TKSA MAGBASE	2 × Magnetic bases, supplied with 2 × fixation screws M8 × 20 mm	-	● ¹⁾	● ¹⁾	●	●
Other						
TKSA 11-EBK	2 × Extendable V-brackets, supplied with 4 × threaded rods of 120 mm (4.7 in.) and 4 × threaded rods of 80 mm (3.1 in.), supplied without chains	●	-	-	-	-
TKSA VBK	2 × Standard V-brackets, supplied without rods or chains	-	●	●	-	-
TKSA 41-QR	5 × A5 sheets with 6x QR code stickers per sheet (total of 30 × stickers)	-	-	●	●	●

¹⁾ Requires offset brackets TKSA EXT50 or TKSA EXT100 for usage with TKSA 31 and TKSA 41.

Alignment

Technical data			
Designation	TKSA 11	TKSA 31	TKSA 41
Sensors and communication	2× Inductive proximity sensors Inclinometer ±0.5°, Bluetooth 4.0 LE	29 mm (1.1 in.) CCD with red line laser Class 2 Inclinometer ±0.5°, Wired, USB cables	29 mm (1.1 in.) CCD with line laser Class 2 Inclinometer ±0.5°; Bluetooth 4.0 LE and wired, USB cables
System measuring distance	0 to 185 mm (0 to 7.3 in.) between brackets, 3 × reference bars included up to 200 mm (7.9 in.)	0.07 to 4 m (0.23 to 13.1 ft) (up to 2 m (6.6 ft) with cables supplied)	0.07 to 4 m (0.23 to 13.1 ft)
Measuring errors	<2%	<0.5% ±5 µm	< 0.5% ±5 µm
Housing material	PC/ABS plastic	20% Glass filled Polycarbonate	20% Glass filled Polycarbonate
Operating time	Up to 18 hours, rechargeable LiPo battery	N/A	Up to 16 hours Rechargeable LiPo battery
Dimensions	105 × 55 × 55 mm (4.1 × 2.2 × 2.2 in.)	120 × 90 × 36 mm (4.7 × 3.5 × 1.4 in.)	120 × 90 × 36 mm (4.7 × 3.5 × 1.4 in.)
Weight	155 g (0.34 lb)	180 g (0.4 lb)	220 g (0.5 lb)
Operating device	iPad Mini recommended, iPad, iPod Touch, iPhone SE, Galaxy devices (not included)	5.6" colour resistive touchscreen LCD display. High impact PC/ABS with overmould	5.6" colour resistive touchscreen LCD display. High impact PC/ABS with overmould
Software/App update	Apple AppStore or on Google Play Store	via USB stick	via USB stick
Operating system requirements	Apple iOS 9 or Android 9 (and above)	N/A	N/A
DU Operating time	N/A	Up to 7 hours (100% backlight)	Up to 8 hours (100% backlight)
Dimensions	N/A	205 × 140 × 60 mm (8.1 × 5.5 × 2.4 in.)	205 × 140 × 60 mm (8.1 × 5.5 × 2.4 in.)
Weight	N/A	420 g (0.9 lb)	640 g (1.4 lb)
Alignment method	Alignment of horizontal shafts 3 position measurement 9–12–3	Alignment of horizontal shafts, 3 position measurement 9 -12 -3 (with min. 140° rotation), automatic measurement, soft foot	Alignment of horizontal shafts, 3 position measurement 9 -12 -3, automatic measurement, measurement (with min. 90° rotation), soft foot
Live correction values	Only for horizontal	Vertical and horizontal	Vertical and horizontal
Extra features	Automatic .pdf report	Machine library, automatic .pdf report	Machine library, QR code reading, automatic .pdf report
Fixture	2× V-brackets with chains, width 15 mm (0.6 in.)	2× V-brackets with chains, width 21 mm (0.8 in.)	2 × V-brackets with chains, width 21 mm (0.8 in.)
Shaft diameters	20 to 160 mm (0.8 to 6.3 in.)	20 to 150 mm (0.8 to 5.9 in.) 300 mm (11.8 in.) with optional extension chains (not included)	20 to 150 mm (0.8 to 5.9 in.) 300 mm (11.8 in.) with optional extension chains (not included)
Max. coupling height ¹⁾	55 mm (2.2 in.) with standard 80 mm rods (Unit should be mounted on the coupling when possible)	105 mm (4.2 in.) with standard rods 195 mm (7.7 in.) with optional extension rods (not included)	105 mm (4.2 in.) with standard rods 195 mm (7.7 in.) with extension rods (included)
Power adapter	Charging via micro USB port (5V) Micro USB to USB charging cable supplied Compatible with 5V USB chargers (not included)	Input: 100V-240V 50/60Hz AC power supplier Output: DC 12V 3A with EU, US, UK, AUS adapters	Input: 100V-240V 50/60Hz AC power supplier Output: DC 12V 3A with EU, US, UK, AUS adapters
Operating temperature	0 to 45 °C (32 to 113 °F)	0 to 45 °C (32 to 113 °F)	0 to 45 °C (32 to 113 °F)
IP rating	IP 54	IP 54	IP 54
Carrying case dimensions	360 × 110 × 260 mm (14.2 × 4.3 × 10.2 in.)	530 × 110 × 360 mm (20.9 × 4.3 × 14.2 in.)	530 × 110 × 360 mm (20.9 × 4.3 × 14.2 in.)
Total weight (incl. case)	2,1 kg (4.6 lb)	4.75 kg (10.5 lb)	4.75 kg (10.5 lb)
Calibration certificate	Supplied with 2 years validity	Supplied with 2 years validity	Supplied with 2 years validity
Case content	Measuring unit; 3 reference bars; 2 shaft brackets with chains 480 mm (18.9 in.) and rods 80 mm (3.1 in.); micro USB to USB charging cable; measuring tape 2 m (6.6 ft.); printed certificate of calibration and conformance; printed quick start guide (EN); SKF carrying case	2 measuring units (M&S); display unit; 2 shaft brackets with chains 400 mm (15.8 in.) and threaded rods 150 mm (5.9 in.); chain tightening rod; power supply with country adapters; 2 USB cables; measuring tape; printed certificate of calibration and conformance; printed quick start guide (EN); SKF carrying case	2 measuring units (M&S); display unit; 2 shaft brackets with chains 400 mm (15.8 in.) and threaded rods 150 mm (5.9 in.); chain tightening rod; 4 threaded extension rods 90 mm (3.5 in.); power supply with country adapters; 2 USB cables; measuring tape; printed certificate of calibration and conformance; printed quick start guide (EN); SKF carrying case; 2 × A5 sheet with 6 × QR code stickers (total of 12 × stickers)

¹⁾ Depending on the coupling, the brackets can be mounted on the coupling, reducing the coupling height limitation.

TKSA 51

20 mm (0.8 in.) PSD with line laser Class 2
Inclinometer $\pm 0.1^\circ$; Bluetooth 4.0 LE

0.07 to 5 m (0.23 to 16.4 ft)

<1% $\pm 10 \mu\text{m}$

Anodized Aluminum front and PC/ABS plastic back cover

Up to 8 hours, rechargeable Li-ion battery
fast charging: 10 min. charging for 1h usage

52 × 64 × 50 mm (2.1 × 2.5 × 2 in.)

190 g (0.4 lb)

iPad Mini recommended

iPad, iPod Touch, iPhone SE, Galaxy devices
(not included)

Apple AppStore or on Google Play Store

Apple iOS 9 or Android 9 (and above)

N/A

N/A

N/A

Alignment of horizontal and vertical shafts,
3 position measurement 9 -12 -3, automatic measurement,
measurement (with min. 40° rotation), soft foot

Vertical and horizontal

Machine library, QR code reading, target values, disturbance
compensation, 3D machine free view, screen rotation on tablets,
automatic .pdf report

2 × V-brackets with chains, width 15 mm (0.6 in.)

20 to 150 mm (0.8 to 5.9 in.)

450 mm (17.7 in.) with extension chains (included)

45 mm (1.8 in.) with standard rods

plus 170 mm (6.7 in.) per set of extension rods

Charging via micro USB port (5V)

Micro USB to USB split charging cable supplied

Compatible with 5V USB chargers (not included)

0 to 45 °C (32 to 113 °F)

IP 54

360 × 110 × 260 mm (14.2 × 4.3 × 10.2 in)

2.9 kg (6.4 lb)

Supplied with 2 years validity

2 measuring units (M&S); 2 shaft brackets with chains 480 mm (18.9
in.), threaded rods 80 mm (3.1 in.) and magnets; 4 threaded extension
rods 120 mm (4.7 in.); 2 extension chains 980 mm (38.6 in.); USB to
micro USB split charging cable; measuring tape; printed certificate
of calibration and conformance; quick start guide (EN); SKF carrying
case; 2 × A5 sheet with 6 × QR code stickers (total 12 × stickers)

TKSA 71, TKSA 71/PRO

20 mm (0.8 in) 2nd gen. PSD with line laser Class 2
inclinometer $\pm 0.1^\circ$; Bluetooth 4.0 LE

0.04 to 10 m (0.13 to 32.8 ft)

<1% $\pm 10 \mu\text{m}$

Anodized aluminum front and PC/ABS plastic back cover

Up to 8 hours, rechargeable Li-ion battery, wireless fast charging
10 min. charging for 1h usage

52 × 64 × 33 mm (2.1 × 2.5 × 1.3 in.)

130 g (0.3 lbs)

iPad Mini recommended

iPad, iPod Touch, iPhone SE, Galaxy devices
(not included)

Apple AppStore or on Google Play store

Apple iOS 9 or Android 9 (and above)

N/A

N/A

N/A

Alignment of horizontal and vertical shafts,
3 position measurement 9 -12 -3, automatic measurement,
measurement (with min. 40° rotation), soft foot,
machine trains, valves, spacer shafts

Vertical and horizontal

Machine library, QR code reading, target values, disturbance
compensation, 3D machine free view, screen rotation on tablets,
automatic .pdf report

2 × V-brackets with chains, width 15 mm (0.6 in.)

20 to 150 mm diameter (0.8 to 5.9 in.),

450 mm (17.7 in.) with extension chains (included)

45 mm (1.8 in.) with standard rods

plus 120 mm (4.7 in.) per set of extension rods

Wireless charging via supplied charging pods

micro USB to USB split charging cable supplied

0 to 45 °C (32 to 113 °F)

IP67 for measuring units and carrying case

TKSA 71 carrying case: 365 × 295 × 170 mm (14.4 × 11.6 × 6.7 in.)

TKSA 71/PRO trolley case: 610 × 430 × 265 mm (24 × 16.9 × 10.4 in.)

TKSA 71: 3.9 kg (8.6 lb) / TKSA 71/PRO: 12.5 kg (27.6 lb)

Supplied with 2 years validity

2 measuring units (M&S); 2 shaft brackets with chains 480 mm (18.9 in.),
threaded rods 80 mm (3.1 in.) and magnets; 4 threaded extension rods
120 mm (4.7 in.); 2 extension chains 980 mm (38.6 in.); micro USB to USB
split charging cable; 2 wireless charging pods; measuring tape; printed
certificate of calibration and conformance; quick start guide (EN);
industrial rugged case (IP 67); 2 × A5 sheet with 6 × QR code stickers (total
12 × stickers) Additionally with TKSA 71/PRO: 4 threaded extension rods
120 mm (4.7 in.); 2 offset brackets 50 mm (2 in.); 2 sliding brackets; 2
magnetic bases

Alignment

For accurate vertical machinery alignment

Machinery shims TMAS series

Accurate machine adjustment is an essential element of any alignment process.

- Made of high quality stainless steel, allowing re-use
- Easy to fit and to remove
- Close tolerances for accurate alignment
- Thickness clearly marked on each shim
- Fully de-burred
- Pre-cut shims are supplied in packs of 10 and complete kits (supplied in carrying cases) are also available

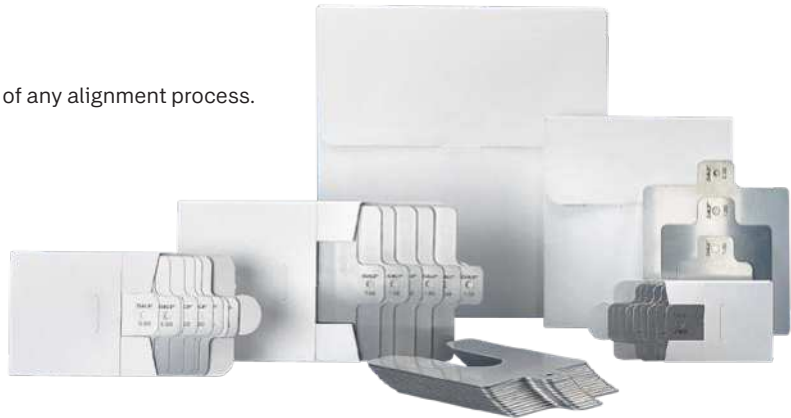

TMAS 340



TMAS 380



TMAS 100/KIT

A 50 mm B 50 mm C 13 mm	
Pack designation	Thickness (mm)
TMAS 50-005	0,05
TMAS 50-010	0,10
TMAS 50-020	0,20
TMAS 50-025	0,25
TMAS 50-040	0,40
TMAS 50-050	0,50
TMAS 50-070	0,70
TMAS 50-100	1,00
TMAS 50-200	2,00
TMAS 50-300	3,00

A 75 mm B 75 mm C 21 mm	
Pack designation	Thickness (mm)
TMAS 75-005	0,05
TMAS 75-010	0,10
TMAS 75-020	0,20
TMAS 75-025	0,25
TMAS 75-040	0,40
TMAS 75-050	0,50
TMAS 75-070	0,70
TMAS 75-100	1,00
TMAS 75-200	2,00
TMAS 75-300	3,00

A 100 mm B 100 mm C 32 mm	
Pack designation	Thickness (mm)
TMAS 100-005	0,05
TMAS 100-010	0,10
TMAS 100-020	0,20
TMAS 100-025	0,25
TMAS 100-040	0,40
TMAS 100-050	0,50
TMAS 100-070	0,70
TMAS 100-100	1,00
TMAS 100-200	2,00
TMAS 100-300	3,00

A 125 mm B 125 mm C 45 mm	
Pack designation	Thickness (mm)
TMAS 125-005	0,05
TMAS 125-010	0,10
TMAS 125-020	0,20
TMAS 125-025	0,25
TMAS 125-040	0,40
TMAS 125-050	0,50
TMAS 125-070	0,70
TMAS 125-100	1,00
TMAS 125-200	2,00
TMAS 125-300	3,00

A 200 mm B 200 mm C 55 mm	
Pack designation	Thickness (mm)
TMAS 200-005	0,05
TMAS 200-010	0,10
TMAS 200-020	0,20
TMAS 200-025	0,25
TMAS 200-040	0,40
TMAS 200-050	0,50
TMAS 200-070	0,70
TMAS 200-100	1,00
TMAS 200-200	2,00
TMAS 200-300	3,00

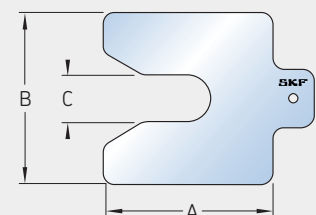

Each pack designation consists of 10 shims.

Shim kits	Designation	Size (mm)	Thickness (mm)								
			0,05	0,10	0,20	0,25	0,40	0,50	0,70	1,00	2,00
Quantities											
TMAS 50/KIT	50 × 50	20	20	20	20	20	20	20	20	20	10
TMAS 75/KIT	75 × 75	20	20	20	20	20	20	20	20	20	10
TMAS 100/KIT	100 × 100	20	20	20	20	20	20	20	20	20	10
TMAS 340	100 × 100	20	20	20	20	20	20	20	20	20	10
	125 × 125	20	20	20	20	20	20	20	20	20	10
TMAS 360	50 × 50	20	20	–	20	–	20	–	20	–	20
	75 × 75	20	20	–	20	–	20	–	20	–	20
	100 × 100	20	20	–	20	–	20	–	20	–	20
TMAS 380	50 × 50	20	20	20	20	20	20	20	20	20	20
	75 × 75	20	20	20	20	20	20	20	20	20	20
TMAS 510	50 × 50	20	20	20	20	20	20	20	20	20	10
	75 × 75	20	20	20	20	20	20	20	20	20	10
	100 × 100	20	20	20	20	20	20	20	20	20	10
TMAS 720 ¹⁾	50 × 50	20	20	20	20	20	20	20	20	20	20
	75 × 75	20	20	20	20	20	20	20	20	20	20
	100 × 100	20	20	20	20	20	20	20	20	20	10
	125 × 125	20	20	20	20	20	20	20	20	20	10

¹⁾ Consists of TMAS 340 + TMAS 380



Alignment

The chocking solution for rotating equipment

SKF Vibracon adjustable chocks

SKF Vibracon chocks are self-leveling and provide the option to reduce profile height. They allow easy, accurate mounting of all types of rotating equipment to base frames and either steel or concrete foundations. They accommodate the angular difference (up to 4°) between machine and mounting base without the need to machine the base or install epoxy resin chocks. The chocks eliminate soft foot- and can lower the cost of equipment foundations – whether they are designed-in or retrofitted.

SKF Vibracon chocking solutions offer you the advantages of:

- A high load capacity
- A broad adjustment range
- An optimized load path through the product
- An optimized bolt/Vibracon combination
- Reduced chock height across the entire range



Carbon steel chocks (E-CS)

SKF Vibracon adjustable chocks can satisfy a range of technical concerns, as they are available in a number of configurations and materials. Chocks made of carbon steel are recommended for indoor use. They provide a cost-effective solution for standard applications, while offering reliable performance in environments such as on the factory floor. Applying additives at the mating surfaces provides initial protection – both before and during installation – and prevents parts from seizing when they are adjusted



Surface treated chocks (E-CSTR)

Chocks are often installed in demanding environments, including humid and salty climates – where enhanced corrosion protection is recommended. (SKF Vibracon chocks were originally developed for marine applications.) To satisfy this need, SKF has tested a range of protective solutions, resulting in its surface-treated chocks. Each part is individually surface treated, which helps to give the chocks a consistent quality and extended performance against corrosion.



Stainless-steel chocks (E-SS)

For the most demanding environments where carbon steel surface-treated chocks will not suffice, SKF has developed a range of stainless-steel chocks. Mating surfaces are treated with additives to prevent parts from seizing when adjusted. Coupled with recent performance improvements, such as increased load capacity, they are suitable but not limited to be used in industries such as oil & gas or offshore.



Low profile chocks (ELP-ASTR)

These surface treated alloy steel low profile chocks are aimed at applications with limited available chocking heights. Low profile chocks offer an economic alternative to the expensive milled chocks, shims or epoxy resins typically used for re-chocking projects or previously designed solutions. Each part is individually surface treated, which helps to give the chocks a consistent quality and extended performance against corrosion. They can be fitted easily and cost-effectively, which helps machine owners who are on a tight installation schedule.

Typical applications

- Marine & offshore
- Power generation – incl. renewable energy
- Food & beverage
- Pulp & paper
- Oil & gas
- Railways
- Agriculture
- Clean room applications



SKF Vibracon adjustment tools

The SKF Vibracon adjustment tools are especially designed for safe height alteration of the SKF Vibracon chocks with comfort.



Technical data

Designation	SKF Vibracon Type range
SMAT 006	SM 12 E – SM 16 E
SMAT 008	SM 20 E - SM 42 E
SMAT 010	SM 48 E - SM 64 E
SMAT 006 LP-3	SM 16 ELP – SM 20 ELP
SMAT 006 LP-4	SM 24 ELP – SM 42 ELP

How to select the appropriate SKF Vibracon chock

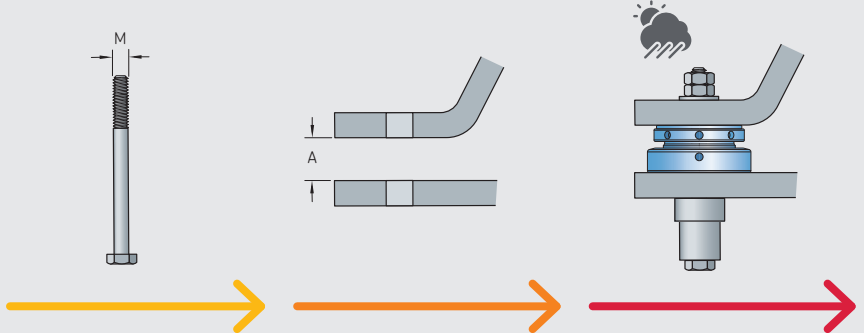

Step 1

Diameter of the foundation bolt (M)

Step 2

Available chocking height (A)

Step 3

Check environmental conditions



Vibracon selection tool

skf.com/vibraconselector

The SKF Vibracon selection tool provides a calculation tool to determine the most suitable SKF Vibracon chock for your application.

Technical data

Bolt size range		Bolt hole diameter d_2		Maximum height A		Minimum height A		Minimum reduced height ¹⁾		Outer diameter D_1		Proof load ²⁾		Designation			
Metric	Imperial	mm	in.	mm	in.	mm	in.	mm	in.	mm	in.	kN	kip.	Suffixes			
M12-M16	1/2"-5/8"	18	0.71	40	1.57	30	1.18	24	0.94	65	2.56	90	20	SM 12 E	-CSTR	-SS	-CS
M16-M20	5/8"-3/4"	22	0.87	48	1.89	35	1.38	26	1.02	80	3.15	140	31	SM 16 E	-CSTR	-SS	-CS
M20-M24	3/4"-1"	27	1.06	54	2.13	40	1.57	30	1.18	100	3.94	200	45	SM 20 E	-CSTR	-SS	-CS
M24-M30	1"-1 1/4"	33	1.30	60	2.36	45	1.77	35	1.38	120	4.72	325	73	SM 24 E	-CSTR	-SS	-CS
M30-M36	1 1/4"-1 1/2"	39	1.54	65	2.56	50	1.97	40	1.57	140	5.51	475	107	SM 30 E	-CSTR	-SS	-CS
M36-M42	1 1/2"-1 3/4"	45	1.77	70	2.76	55	2.17	45	1.77	160	6.30	650	146	SM 36 E	-CSTR	-SS	-CS
M42-M48	1 3/4"-2"	52	2.05	75	2.95	60	2.36	50	1.97	190	7.48	850	191	SM 42 E	-CSTR	-SS	-CS
M48-M56	2"-2 1/4"	60	2.36	89	3.50	70	2.76	59	2.32	210	8.27	1150	259	SM 48 E	-CSTR	-SS	-CS
M56-M64	2 1/4"-2 1/2"	68	2.68	94	3.70	75	2.95	64	2.52	230	9.06	1500	337	SM 56 E	-CSTR	-SS	-CS
M64-M68	2 1/2"-2 3/4"	78	3.07	99	3.90	80	3.15	69	2.72	260	10.24	2000	450	SM 64 E	-CSTR	-SS	-CS

SKF Vibracon low profile

M16-M20	5/8"-3/4"	22	0.87	37	1.46	25	0.98	17	0.67	80	3.15	140	31	SM 16 ELP	-ASTR
M20-M24	3/4"-1"	27	1.06	37	1.46	25	0.98	17	0.67	100	3.94	200	45	SM 20 ELP	-ASTR
M24-M30	1"-1 1/4"	33	1.30	37	1.46	25	0.98	17	0.67	120	4.72	325	73	SM 24 ELP	-ASTR
M30-M36	1 1/4"-1 1/2"	39	1.54	37	1.46	25	0.98	17	0.67	140	5.51	475	107	SM 30 ELP	-ASTR
M36-M42	1 1/2"-1 3/4"	45	1.77	42	1.65	30	1.18	22	0.87	160	6.30	650	146	SM 36 ELP	-ASTR
M42-M48	1 3/4"-2"	52	2.05	47	1.85	35	1.38	27	1.06	190	7.48	850	191	SM 42 ELP	-ASTR

¹⁾ The minimum height of the product can be reduced on a lathe if required.

²⁾ Recommended maximum load on the SKF Vibracon corresponding with the proof load of the recommended maximum metric bolt size.

More detailed technical specifications can be found in the Vibracon selection tool on skf.com/vibraconselector

Technical data can be subject to changes without prior notice

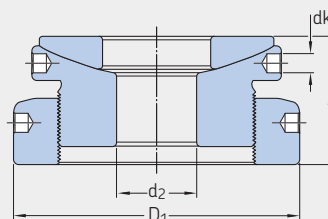

SKF Vibracon

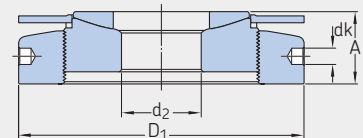

SKF Vibracon low profile

Alignment



Straight bolt tensioning for longer endurance

Spherical washers

Spherical washers are designed to create an exact, parallel plane between the bolt head and the face of the nut. SKF spherical washers automatically adjust and compensate for the angular deviation between the planes and prevent the bolt from bending.

Product characteristics:

- Automatically compensates for angular errors
- Evenly distributed bolt tension
- Reduces bolt fatigue from bending bolts
- Improved bolt stretch possible due to increased clamping length
- Surface treated for protection in humid and harsh environments
- Available in standard and low-profile (LP) versions

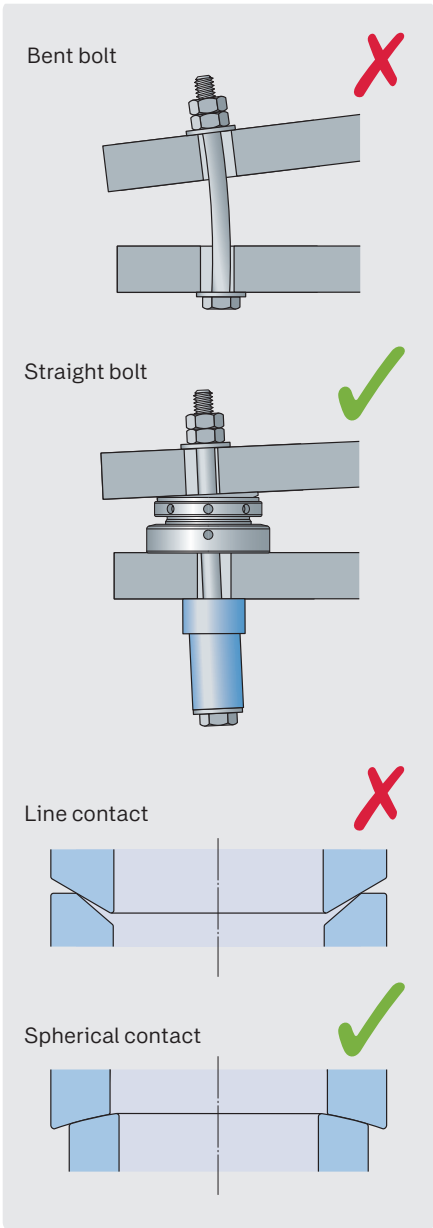

Dimensions - standard (mm)

Designation	D	d	H
SMSW 16-ASTR	33	17	60
SMSW 20-ASTR	42	23	60
SMSW 24-ASTR	47	27	60
SMSW 27-ASTR	52	30	60
SMSW 30-ASTR	56	34	60
SMSW 36-ASTR	67	40	60
SMSW 42-ASTR	82	46	60
SMSW 48-ASTR	92	52	60

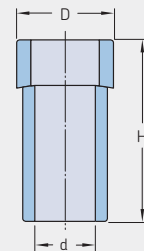

low-profile (mm)

Designation	D	d	H
SMSW 16LPAST	33	17	20
SMSW 20LPAST	42	23	22
SMSW 24LPAST	47	27	24
SMSW 27LPAST	52	30	26
SMSW 30LPAST	56	34	28
SMSW 36LPAST	67	40	30
SMSW 42LPAST	82	46	34

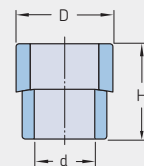

Please contact your local SKF Authorised Distributor or SKF sales representative for support, customization or more information about spherical washers from SKF.

Belt alignment tools

One of the common reasons for unplanned downtime of belt-driven machinery is pulley misalignment. Pulley misalignment can increase wear on pulleys and belts as well as increasing the noise and vibration level, that can result in unplanned machinery downtime. Another side effect of increased vibration is premature bearing failure. This too can cause unplanned machinery downtime.

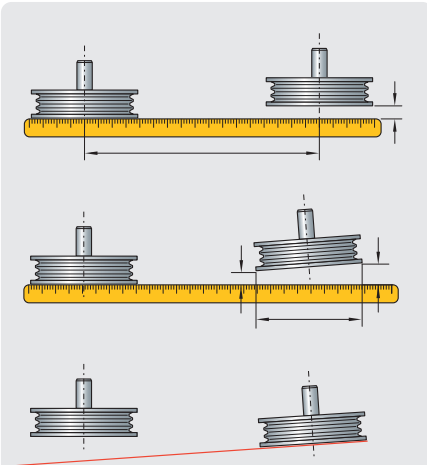

Measuring parallel and angular misalignment using a straight edge or a piece of string

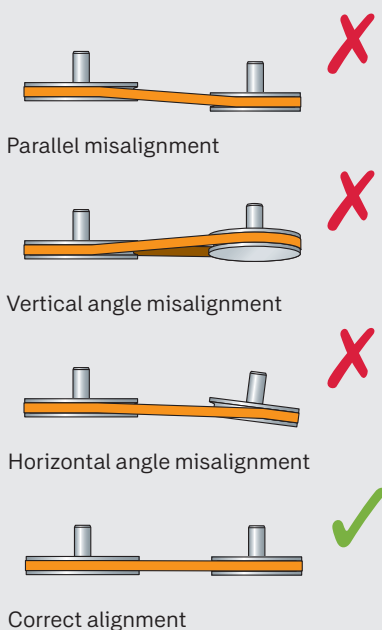

Traditional belt alignment methods

These methods are usually visual in combination with a straight edge and/or length of string. Although quick to perform, they are often inaccurate.

Laser belt alignment methods

Using a laser belt alignment tool is quicker and more accurate than traditional methods. Belt alignment tools can either align the pulley faces or the pulley grooves.

Accurate pulley and belt alignment can help you:

- Increase bearing life
- Increase machinery uptime, efficiency and productivity
- Reduce wear on pulleys and belts
- Reduce friction and thereby energy consumption
- Reduce noise and vibration
- Reduce costs of replacing components and machinery downtime



Alignment

Accurate alignment of pulleys and sprockets

Belt alignment tools TKBA Series

SKF offers a range of three different belt alignment tools to enable accurate alignment for almost all applications. The tools are designed to be easy to use without any special training. The laser position indicates the nature of misalignment allowing easy and accurate adjustment.

The TKBA Belt alignment tools accurately align pulleys and sprockets and correct for various types of misalignment. Each tool has two components; a laser-emitting unit and three passive targets. Each is attached quickly and easily – using a powerful magnet – to the inside or outside face of a belt pulley or chain sprocket.

The laser line is projected from the emitting unit to the receiver unit or the passive targets to correct for vertical angle, horizontal angle and parallel misalignment – including combinations of all three. The sturdy housings, made from ABS and 2K polymers and an aluminium base help ensure assembly stability and accuracy during alignment.



Precision tool for pulley and chain drive alignment

TKBA 11

- One laser emitter with three passive targets
- Uses a red laser diode allowing for distances up to 3 m (10 ft).
- Fast, easy attachment
- Simplified alignment process
- Simultaneous adjustment of tension and alignment
- Applicable to most machines using V belts, banded belts, ribbed belts – as well as chain sprockets



Versatile tool for pulley and chain drive alignment

TKBA 21

- Two laser transmitter/receiver units
- Uses red laser diodes allowing for distances up to 3 m (10 ft).
- Fast, easy attachment – using powerful magnets
- Simplified alignment process
- Simultaneous adjustment of tension and alignment
- Applicable to most machines using V belts, banded belts, ribbed belts – as well as chain sprockets



Typical applications

Belt alignment tools are commonly used in power plants, recycling facilities, chemical plants and food & beverage production.

Belt drives are found in a variety of applications, including HVAC, pump installations, paper mills, flour mills, lathe machines, milling machines and conveyors. Sprocket drives are often used in agricultural machinery, compressors and engine camshafts.

Aligning belt drives and chain drives accurately helps to reduce wear on belts, pulleys, chains and sprockets. As well as extending belt and pulley life, a precise alignment also reduces machine vibration. Typical benefits of this include improved machine performance, a reduction in unscheduled downtime and lower energy costs.

Advanced tool for pulley and chain drive alignment

TKBA 31

- Two laser transmitter/receiver units
- Each unit uses a green laser diode and can be used for distances up to 6 m (20 ft) – including outdoors in sunny conditions
- Three passive targets
- Three belt tension checkers
- Wear check gauge
- Fast, easy attachment – using powerful magnets
- Simplified alignment process
- Simultaneous adjustment of tension and alignment
- Applicable to most machines using V belts, banded belts, ribbed belts – as well as chain sprockets



Belt tesnsion checkers and Wear check gauge supplied with TKBA 31

Alignment

High-accuracy tool for V-belt pulley alignment

Belt alignment tool TKBA 40

Belt-driven machinery must be precisely aligned in order to increase belt and pulley life – and reduce both machine vibration and energy costs.

Belt alignment tool TKBA 40 offers a straightforward way to do this, by accurately aligning the grooves of V-belt pulleys. It can correct for vertical angle, horizontal angle and parallel misalignment. The tool has two components – a laser-emitting unit and a receiver unit. It uses powerful magnets and V-guides to fit to the pulley's grooves, allowing the TKBA 40 to be attached quickly and easily.

Benefits

- Fast, easy attachment – using powerful magnets
- Simplified alignment process
- Ability to align a wide range of V-belt pulleys, as four sizes of V-guide are supplied
- Simultaneous adjustment of tension and alignment
- Aligns grooves – rather than faces – of V-belt pulley, for optimum alignment of pulleys of dissimilar widths or faces.

Features

- Optional extra: a special side adaptor allows alignment of multi-ribbed and timing belt pulleys, as well as sprockets
- Maximum operating distance of 6 m (20 ft) accommodates many applications
- Relies on red laser diode, and supplied in sturdy carrying case
- Runs on 2 × AAA batteries for 20 hours' continuous operation.



The laser unit emits a laser line that is projected onto the receiver unit. A three-dimensional target area on the receiver unit allows easy detection of the type of misalignment and how to correct it. Belt alignment is achieved when the laser line coincides with the three reference lines on the receiver unit.

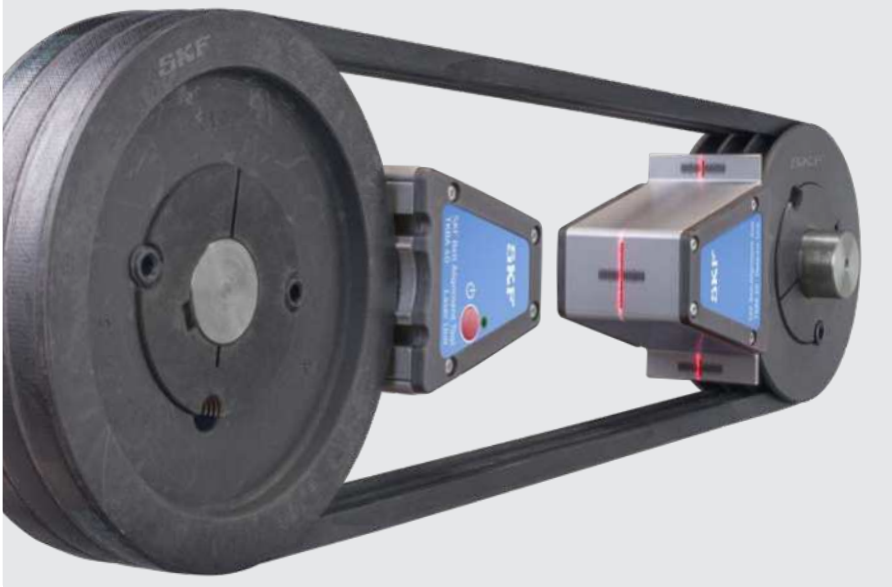

The TKBA 40 is supplied with four sizes of V-guide – to fit pulley grooves of most widths and types. Exchanging a V-guide for a smaller or larger one is a straightforward operation. The TKBA 40 can be applied to a number of end-use applications:

Belt drives

- HVAC
- Pump installations
- Paper mills
- Flour mills
- Lathe machine
- Milling machines
- Conveyors

Sprocket drives

- Agricultural machinery
- Compressors
- Engine camshafts

Technical data				
Designation	TKBA 11	TKBA 21	TKBA 31	TKBA 40
Transmitter/emitter unit				
Type of laser	Red laser diode	Red laser diode	Green laser diode	Red laser diode
Laser	1x Built-in class 2 laser, <1mW, 635nm	1x Built-in class 2 laser, <1mW, 635nm	1x Built-in class 2 laser, <1mW, 520nm	1 × Built-in class 2 laser, <1 mW, 632 nm
Laser line length	2.4 m at 2 m (7.9 ft at 6.6 ft)	2.4 m at 2 m (7.9 ft at 6.6 ft)	2.4 m at 2 m (7.9 ft at 6.6 ft)	3 m at 2 m (9.8 ft at 6.6 ft)
Measurement accuracy				
- Angular	Better than 0.02° at 2 m (6.6 ft)	Better than 0.02° at 2 m (6.6 ft)	Better than 0.02° at 2 m (6.6 ft)	Better than 0.2°
- Offset	Better than 0.5 mm (1/50" in.)	Better than 0.5 mm (1/50" in.)	Better than 0.5 mm (1/50" in.)	Better than 0.5 mm (0.02 in.)
Measurement distance	50 to 3 m (2 to 10 ft)	50 to 3 m (2 to 10 ft)	50 to 6 m (2 to 20 ft)	50 to 6 000 mm (2 to 20 ft)
Control	Laser ON/OFF	Laser ON/OFF	Laser ON/OFF	Laser on/off switch
Housing material	ABS + 2K and Aluminium base powder coat finish	ABS + 2K and Aluminium base powder coat finish	ABS + 2K and Aluminium base powder coat finish	Extruded aluminium
Receiver unit				
Housing material	Passive targets: ABS	Same as transmitter unit	Same as transmitter unit Passive targets: ABS	Aluminium
Fixtures				
Mounting	Magnetic, side mounted	Magnetic, side mounted	Magnetic, side mounted	Magnetic, groove mounted (optional side adapter TMEB A2)
V-guides	N/A	N/A	N/A	Size 1: 22 mm, short rods (3× pairs) Size 2: 22 mm, long rods (3× pairs) Size 3: 40 mm, short rods (3× pairs) Size 4: 40 mm, long rods (3× pairs)
Battery	3 x AAA Alkaline type IEC LR03	3 x AAA Alkaline type IEC LR03	3 x AAA Alkaline type IEC LR03	2× AAA Alkaline type IEC LR03
Operation time	32 hours (continuous operation)	32 hours (continuous operation)	6 hours (continuous operation)	20 hours (continuous operation)
Operating requirements				
Operating temperature	0 to 40 °C (32 to 104 °F)	0 to 40 °C (32 to 104 °F)	0 to 40 °C (32 to 104 °F)	0 to 40 °C (32 to 104 °F)
Storage temperature	- 20 to 60 °C (-4 to 140 °F)	- 20 to 60 °C (-4 to 140 °F)	- 20 to 60 °C (-4 to 140 °F)	-20 to +65 °C (-4 to +150 °F)
Relative humidity	10 to 90% RH non-condensing	10 to 90% RH non-condensing	10 to 90% RH non-condensing	10 to 90% RH non-condensing
IP rating	IP 40	IP 40	IP 40	IP 40
Calibration certificate	-	-	-	Valid for two years
Dimensions				
Transmitter/emitter unit	98 x 97 x 52 mm (3.86 x 3.82 x 2.05 in.)	98 x 97 x 52 mm (3.86 x 3.82 x 2.05 in.)	98 x 97 x 52 mm (3.86 x 3.82 x 2.05 in.)	70 x 74 x 61 mm (2.8 x 2.9 x 2.4 in.)
Receiver unit	Passive targets: 40 x 25 mm (1.57 x 0.98 in.)	Same as transmitter unit	Same as transmitter unit Passive targets: 40 x 25 mm (1.57 x 0.98 in.)	96 x 74 x 61 mm (3.8 x 2.9 x 2.4 in.)
Carrying case dimensions	260 x 85 x 180 mm (10.2 x 3.3 x 7.1 in.)	360 x 110 x 260 mm (14.2 x 4.3 x 10.2 in.)	360 x 110 x 260 mm (14.2 x 4.3 x 10.2 in.)	260 x 85 x 180 mm (10.2 x 3.4 x 7.0 in.)
Weight				
Transmitter/emitter unit	250 g (0.55 lb) with batteries	250 g (0.55 lb) with batteries	250 g (0.55 lb) with batteries	320 g (0.7 lb)
Receiver unit	35 g (0.08 lb) 3 pcs passive targets	Same as transmitter unit	Same as transmitter unit	270 g (0.6 lb)
Total (incl. case)	0.84 kg (1.85 lb)	1.62 kg (3.57 lb)	1.88 kg (4.14 lb)	1.2 kg (2.7 lb)
Case contents				
	1 x TKBA 11 transmitter unit 3 x TKBA TARGET passive targets 3 x AAA batteries 1 x Printed Instructions for use	2 x TKBA 21 transmitter / receiver unit 6 x AAA batteries 1 x Printed Instructions for use	2 x TKBA 31 transmitter/ receiver unit 3 x TKBA TARGET passive targets 6 x AAA batteries 3 x Belt tension checkers of different loads 1 x Pulley groove profile checker 1 x Printed Instructions for use	1 x TKBA 40 transmitter unit 1 x TKBA 40 receiver unit 2 x AA batteries 4 x sizes of V-guides, 3 × of each size 1 x Printed instructions for use 1 x Calibration certificate

Basic condition monitoring

To help ensure long bearing service life, it is important to determine the condition of machinery and bearings while in operation. Good predictive maintenance will help reduce machine downtime and decrease overall maintenance costs. To help you achieve the maximum service life from your bearings, SKF has developed a wide range of instruments for analysing the critical environmental conditions which have an impact on bearing and machine performance.

Maintenance concepts

Run to failure

Run to failure occurs when repair action is not taken until a problem results in machine failure. Run to failure problems often cause costly secondary damage along with unplanned downtime and maintenance costs.

Preventive maintenance

Preventive maintenance implies that a machine, or parts of a machine, are overhauled on a regular basis regardless of the condition of the parts. While preferable to run to failure maintenance, preventive maintenance is costly because of excessive downtime from unnecessary overhauls and the cost of replacing good parts along with worn parts.

Predictive maintenance

Condition monitoring/predictive maintenance is the process of determining the condition of machinery while in operation. This enables the repair of problem components prior to failure. Condition monitoring not only helps plant personnel reduce the possibility of catastrophic failure, but also allows them to order parts in advance, schedule manpower, and plan other repairs during the downtime. With condition monitoring, machinery analysis takes two overlapping forms: predictive and diagnostic.

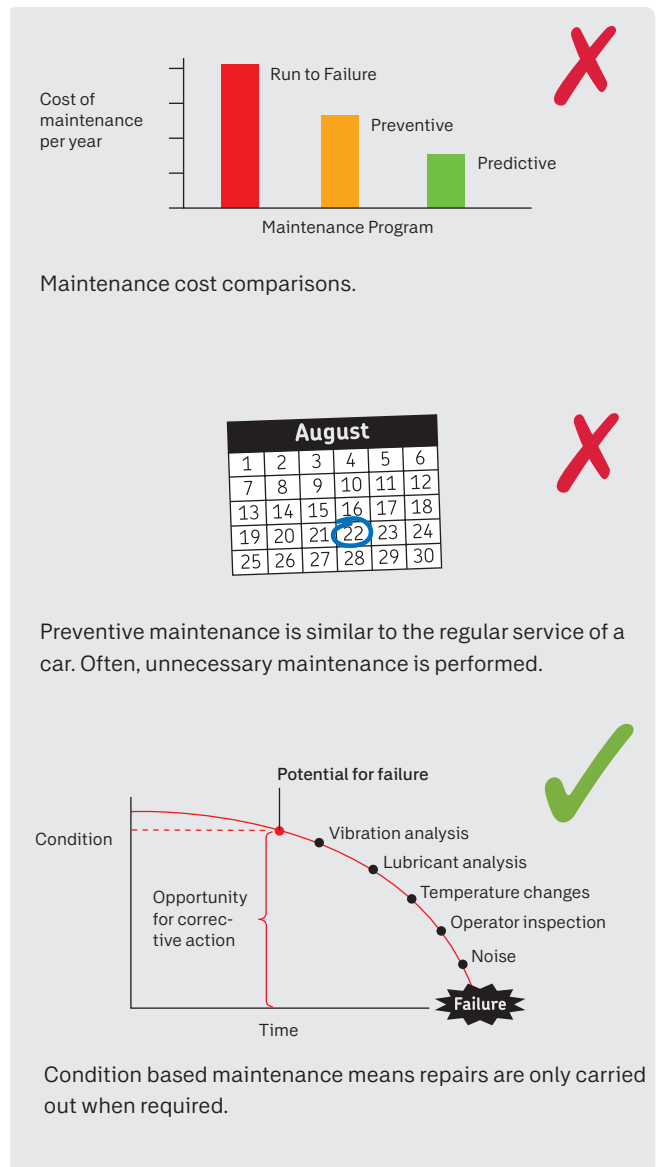

SKF has developed a comprehensive range of basic condition monitoring tools suitable for Operator Driven Reliability (ODR) and maintenance technicians. Under ODR, some maintenance practices are owned, managed, and performed by operators. Often, the operators are the best persons equipped for basic inspection activities, as they know their part of the plant very well. They are often sensitive to minor changes in sounds and vibrations that may not be apparent to someone lacking their front-line experience.

Subsequently, minor defects can be corrected quickly, as the operator can undertake simple adjustment and repair tasks. Maintenance technicians also have need for basic condition monitoring tools.

If, for example, abnormal vibrations are detected or if an operator reports an abnormal running condition, then the technician can often use some basic condition monitoring tools to detect the root cause for further evaluation.

SKF basic condition monitoring tools can be used to check a number of properties:

Temperature

Since the dawn of the industrial age, operators and technicians know that abnormal temperatures often indicate that something is wrong with the machine. Thermometers can help find and then measure these hotspots, allowing further analysis to be conducted.



Speed

Machines are usually designed to run at a given speed. If the speed is too slow or too fast, then the overall process can be compromised. Using a hand-held tachometer enables a quick and easy assessment of the machine's running speed.



Visual

Visual inspection of a machine's condition can sometimes be difficult when it's running or when there is a need to inspect the machine internally.

A stroboscope can be used to visually freeze the motion of a machine to allow such things as fan blades, couplings and belt drives to be inspected while running. To inspect the internal parts of a machine often requires disassembly. By using an endoscope, it is possible to access the area of interest with minimal disassembly, saving time and money.



Basic condition monitoring

Sound

Abnormal sounds from machines often indicate that something is wrong. A stethoscope can be used to help pinpoint the source of the sound and can aid the technician in identifying the problem. Leaks in compressed air systems are costly, not only in energy costs but also due to extra costs in air compressor maintenance. Ultrasonic leak detectors can help detect leaks efficiently, allowing the necessary repairs to be made. Excessive noise can cause worker fatigue, increased accidents and loss of hearing. A sound pressure meter can measure the sound level, allowing corrective measures to be made.



Electrical discharge currents

Electrical discharges are a result of motor shaft voltages discharging to earth through the bearing, causing electrical erosion, lubricant degradation and ultimately bearing failure. An electrical discharge detector can help detect the presence of electrical discharge currents, allowing remedial action to be taken.



Vibration

Abnormal vibrations are often the first indication of a potential machine failure. These vibrations can be caused by such conditions as unbalance, misalignment, looseness of parts, rolling element bearing and gear damage. Vibration analysis instruments and systems, can help detect many serious problems at an early stage, allowing remedial work to be undertaken in a timely manner.



Lubricant condition

To maintain the optimum condition of rolling element bearings, it is essential that the lubricant is in good condition. Checking the oil or grease condition at regular intervals can reduce downtime and greatly prolong the life of rolling element bearings.





Accurate temperature measurement with dual channel capability

Thermometer TKDT 10

The SKF TKDT 10 is suitable for a wide range of applications and has the ability to have two SKF temperature probes connected. A large back-lit LCD display helps ensure that the temperatures can be easily read in almost all lighting conditions.

- Large back-lit LCD display
- Supplied with temperature probe TMDT 2-30 (max. 900 °C (1 652 °F)); suitable for many direct contact applications.
- Can be used with an optional second SKF temperature probe enabling either probe temperature, or the temperature difference between the probes, to be displayed.
- Temperature display can be frozen for ease of reading.
- User selectable auto power off function increases battery life.



Technical data

Designation	TKDT 10
Display	Large back-lit LCD
Displayed resolution	0.1° up to 1 000 °, otherwise 1°
Measurement modes	Min, max, average, differential, dual temperature reading
Measurement units	°C, °F, K
Temperature using probe	-200 to +1 372 °C (-328 to +2 501 °F)
Accuracy	>-100 °C (>-148 °F): ±0.5% of reading ±1 °C (1.8 °F)
Probe compatibility	2 × Type-K connectors
Probe supplied	TMDT 2-30, suitable for use up to 900 °C (1 650 °F)
Battery	3 × AAA Alkaline type IEC LR03
Operation time	18 hours typical use (backlight on)
Product dimensions	160 × 63 × 30 mm (6.3 × 2.5 × 1.2 in.)
Carrying case dimensions	530 × 85 × 180 mm (20.9 × 3.4 × 7.0 in.)
Product weight	200 g (0.4 lb)

Dual temperature measurement



Temperature difference between the probes



Basic condition monitoring

Safe temperature measurement at a distance

Infrared thermometers

SKF offers a wide range of portable, lightweight and easy-to-use infrared thermometers for thermal inspections. These portable tools help you to detect temperature differences in technical and non-technical applications, this in order to perceive information on abnormalities in operating.

SKF Infrared thermometers are fitted with multiple lasers which helps you to easy and more accurate target the object. The TKTL 21, 31 and 40 also offer you the option of measuring temperatures via a temperature probe. The TKTL 40 offers you the possibility of data logging and allows pictures and videos with all measurement information to be taken.

TKTL 11

Basic infrared thermometer

- LCD colour display
- 8 laser targeting
- Fixed emissivity
- High accuracy
- Fast response time
- DS ratio of 16:1



DS ratio
16:1

0,95
Emissivity

TKTL 11

TKTL 21

Advanced infrared thermometer

- LCD colour display
- 8 laser targeting
- Type-K thermocouple probe
- Adjustable emissivity
- High accuracy
- Fast response time
- DS ratio of 30:1



DS ratio
30:1

0,1-1,0
Emissivity

TKTL 21

TKTL 31

High performance infrared thermometer

- LCD monochrome display, backlit
- Dual laser targeting
- Type-K thermocouple probe
- Adjustable emissivity
- High accuracy
- Fast response time
- DS ratio of 75:1



DS ratio
75:1

0,1-1,0
Emissivity

TKTL 31

To help ensure long bearing service life, it is important to determine the condition of machinery and bearings while in operation. Good predictive maintenance will help reduce machine downtime and decrease overall maintenance costs. SKF Infrared thermometers help analysing critical environmental conditions that have an impact on bearing and machine performance.

TKTL 40

Dual laser infrared and contact video thermometer

- 2.2" TFT LCD display
- 640 x 480 pixels digital camera
- Internal memory expandable to 8 GB
- Image (JPEG) and video (MP4)
- Humidity and air temperature
- Dual laser targeting
- Type-K thermocouple probe
- Adjustable emissivity
- High accuracy
- Fast response time
- Dewpoint temperature and wet bulb temperature



DS ratio
50:1



0,1-1,0
Emissivity

TKTL 40



SKF Infrared thermometers can also be used for temperature measurements in areas such as

HVAC

- Balance room temperatures
- Monitor supply/return registers
- Test ductwork
- Examine stream traps
- Check furnace performance
- Perform energy audits

Food safety

- Check cold and hot cooking, holding and serving temperatures
- Helps ensure safe and uniform storage and transportation temperatures
- Maintain freezers, walk-ins, ovens, ranges and dishwashers

Furthermore

- Roofing, asphalt, and concrete applications
- Commercial printing
- Plastics moulding
- Fire detection/prevention
- Aviation and marine maintenance

Technical data				
Designation	TKTL 11	TKTL 21	TKTL 31	TKTL 40
Temperature range using infrared	-60 to +625 °C (-76 to +1157 °F)	-60 to +760 °C (-76 to +1400 °F)	-60 to +1600 °C (-76 to +2912 °F)	-50 to +1000 °C (-58 to +1832 °F)
Temperature range using probe	-	-64 to +1400 °C (-83 to +2552 °F)	-64 to +1400 °C (-83 to +2552 °F)	-50 to +1370 °C (-58 to +2498 °F)
Probe supplied	-	TMDT 2-30 included (max. 900 °C (1650 °F))	TMDT 2-30 included (max. 900 °C (1650 °F))	TMDT 2-30 included (max. 900 °C (1650 °F))
Distance-to-spot ratio	16:1	30:1	75:1	50:1
Emissivity	0.95	0.1-1.0	0.1-1.0	0.1-1.0
Measurement accuracy	+/-2% of reading or 2 °C (4 °F) whichever is greater	+/-2% of reading or 2 °C (4 °F) whichever is greater	+/-1% of reading or 1 °C (1.8 °F) whichever is greater	+/-1% of reading or 1 °C (1.8 °F) whichever is greater
Operating temperature	0 to 50 °C (32 to 122 °F) 10 to 95% R.H.	0 to 50 °C (32 to 122 °F) 10 to 95% R.H.	0 to 50 °C (32 to 122 °F) 10 to 95% R.H.	0 to 50 °C (32 to 122 °F) 10 to 95% R.H.
Storage	-10 to +60 °C (-14 to +140 °F) 10 to 95% R.H.	-10 to +60 °C (-14 to +140 °F) 10 to 95% R.H.	-10 to +60 °C (-14 to +140 °F) 10 to 95% R.H.	-10 to +60 °C (-14 to +140 °F) 10 to 95% R.H.
Response time msec	1000	1000	1000	<300
Displayed resolution	0.1 °C/F (below 999.9), 1 °C/F (above 1000)	0.1 °C/F (below 999.9), 1 °C/F (above 1000)	0.1 °C/F (below 999.9), 1 °C/F (above 1000)	0.1 °C/F (below 999.9), 1 °C/F (above 1000)
Display	Colour backlit LCD	Colour backlit LCD	Monochrome backlit LCD	Colour backlit LCD
Spectral response	8-14 µm	8-14 µm	8-14 µm	8-14 µm
Measurement modes	Maximum temperatures	Maximum; Minimum; Average; Difference (between min and max); Probe/IR dual temperature	Maximum; Minimum; Average; Difference (between min and max); Probe/IR dual temperature	Maximum; Minimum; Average; Difference (between min and max); Probe/IR dual temperature
Alarm modes	-	High and low level alarm with warning sound	High and low level alarm with warning sound	High and low level alarm with warning sound
Laser	8x red targeting laser dots, Class 2	8x red targeting laser dots, Class 2	2x red targeting laser dots, Class 2	2x red targeting laser dots, Class 2
Operating time	Min. 9 hours continuous use	Min. 30 hours continuous use without laser	Min. 140 hours continuous use without laser and back light	Min. 4 hours continuous use
Measurement modes	Max. temperatures	Max, min, differential, average, probe/IR dual temperature modes	Max, min, differential, average, probe/IR dual temperature modes	Max, min, differential, average, probe/IR dual temperature modes
Auto switch off	Automatic, 15 seconds after trigger release	Automatic, 60 seconds after trigger release in IR mode and 12 minutes after trigger release in probe mode	Automatic, 60 seconds after trigger release in IR mode (60 minutes can be manually selected) and 12 minutes after trigger release in probe mode	Automatic, user selectable
HVAC functionalities	-	-	-	Wet bulb, dew point, humidity, air temperature
Photo and video	-	-	-	640 x 480 camera, images (JPEG) and video (3 GP)
Memory	-	-	-	310 MB internal memory; expandable with micro SD card (8 GB max.)
PC connection	-	-	-	Mini USB port, mini USB to USB cable included
Contents	1x IR thermometer (TKTL 11); 2x AAA Alkaline batteries; 1x Instructions for use	1x IR thermometer (TKTL 21); 1x Temperature probe (TMDT 2-30); 2x AAA Alkaline batteries; 1x Instructions for use; 1x Carrying case	1x IR thermometer (TKTL 31); 1x Temperature probe (TMDT 2-30); 2x AAA Alkaline batteries; 1x Instructions for use; 1x Carrying case	1x IR thermometer (TKTL 40); 1x Temperature probe (TMDT 2-30); 1x AC battery charger; 1x Mini USB to USB connection cable 1x Mini tripod 1x Instructions for use; 1x Carrying case
Product dimensions	119.2 × 171.8 × 47.5 mm (4.7 × 6.8 × 1.9 in.)	119.2 × 171.8 × 47.5 mm (4.7 × 6.8 × 1.9 in.)	203 × 197 × 47 mm (8.0 × 7.7 × 1.8 in.)	205 × 155 × 62 mm (8.1 × 6.1 × 2.4 in.)
Packing dimensions	253 × 67 × 136 mm (9.96 × 2.64 × 5.35 in.)	530 × 85 × 180 mm (20.9 × 3.4 × 7.0 in.)	530 × 85 × 180 mm (20.9 × 3.4 × 7.0 in.)	530 × 85 × 180 mm (20.9 × 3.4 × 7.0 in.)
Product weight (incl. batteries)	255.7 g (0.56 lb)	255.7 g (0.56 lb)	386.1 g (0.85 lb)	600 g (1.3 lb)
Total weight	400 g (0.88 lb)	1150 g (2.54 lb)	1300 g (2.87 lb)	1700 g (3.8 lb)







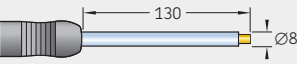
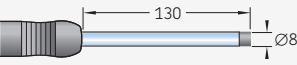

Technical data – Thermocouple probes

Probe type	K-type thermocouple (NiCr/NiAl) acc. IEC 584 Class 1
Accuracy	±1.5 °C (2.7 °F) up to 375 °C (707 °F) ±0.4% of reading above 375 °C (707 °F)
Handle	110 mm (4.3 in.) long
Cable	1000 mm (39.4 in.) spiral cable (excl. TMDT 2-31, -38, -39)
Plug	K-type mini-plug (1260-K)

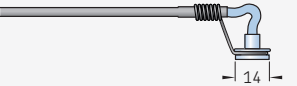
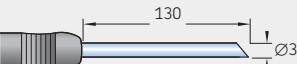
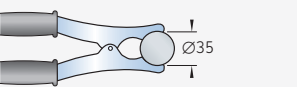
For use with SKF Thermometers TKDT 10, TKTL 21, TKTL 31 and TKTL 40

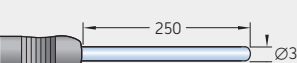
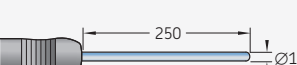
K-type thermocouple probes TMDT 2 series

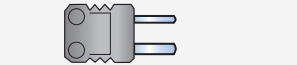
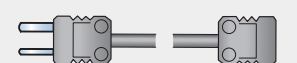
Dimensions (mm)	Designation	Description	Max. temp	Response time
	TMDT 2-30	Standard surface probe For hard surfaces such as bearings, bearing housings, engine blocks, oven shields, etc.	900 °C (1 650 °F)	2.3 s
	TMDT 2-43	Heavy duty surface probe Same as TMDT 2-30, but with a silicone encapsulated tip for heavy duty applications.	300 °C (570 °F)	3.0 s
	TMDT 2-33	Right angle surface probe For hard surfaces in heavy-duty applications, e.g. machine components, engines, etc.	450 °C (840 °F)	8.0 s
	TMDT 2-31	Magnetic surface probe For hard, magnetic surfaces; the integral heat sink design and low mass minimise thermal inertia and provide an accurate temperature measurement.	240 °C (460 °F)	7.0 s
	TMDT 2-35	Probe with sharp tip Can be easily inserted into semi-solid materials like food-stuffs, meat, plastic, asphalt, deep-frozen products, etc.	600 °C (1 110 °F)	12.0 s
	TMDT 2-36	Pipe clamp probe For temperature measuring on pipes, cables, etc. Diameter up to \varnothing 35 mm (1.4 in.).	200 °C (390 °F)	8.0 s
	TMDT 2-38	Wire probe Thin, lightweight, very fast response, fibreglass insulated.	300 °C (570 °F)	5.0 s
	TMDT 2-39	High temperature wire probe Thin, light weight, very fast response, ceramic insulation.	1 350 °C (2 460 °F)	6.0 s
	TMDT 2-34	Gas and liquid probe Flexible shank made of stainless steel for liquids, oils, acids, etc. and for use with high temperatures, e.g. open fire (not for molten metals).	1 100 °C (2 010 °F)	12.0 s
	TMDT 2-34/1.5	Gas and liquid probe Same as TMDT 2-34 but with thin shank and faster response time. Very flexible, especially suitable for measuring temperature of gases.	900 °C (1 650 °F)	6.0 s
	TMDT 2-40	Rotating probe For moving or rotating smooth surfaces. Four roller bearings provide suitable contact with the surfaces. Max. velocity 500 m/min.	200 °C (390 °F)	0.6 s
	TMDT 2-42	Ambient temperature probe For measurement of ambient temperature.		
	TMDT 2-37	Extension cable For use with all K-type probes. Special lengths are available on request.		

All probes can be used with the SKF digital thermometers TKDT 10, TKTL 21, TKTL 31 and TKTL 40 without recalibration.

Basic condition monitoring

Digital devices to gather critical machine data

Tachometers

SKF offers its TKRT range of tachometers, which use laser or contact measurement to determine the rotational and linear speed of rotating equipment. Each handheld device is compact in design, and offers fast, accurate measurement. The laser sensor allows measurements to be made at a safe distance from rotating machinery. Each device is supplied with contact adaptors and uses standard or rechargeable batteries. Output information is clearly displayed on a large, easy-to-read screen.

Measurement modes include: rotational speed, total revolutions, frequency, surface speed and length – in both metric and imperial units. The breadth of measurement modes, and wide speed range, make the tachometers suitable for use in a variety of applications.

TKRT 10

Digital tachometer

- Laser/contact measuring system
- Wide speed measurement range
- Multiple measurement modes
- Large, back-lit LCD display
- Angular range of $\pm 45^\circ$ for easy measuring
- Up to 10 readings stored for reference
- Includes basic set of contact adaptors



TKRT 10



TKRT 21

Multi-functional digital tachometer

- Laser/contact measuring system
- Wide speed measurement range
- Multiple measurement modes
- Large LCD display
- Includes basic set of contact adaptors
- Uses standard or rechargeable batteries



TKRT 21



TKRT 31

Advanced digital tachometer

- Large colour-backlit TFT display
- Measures linear and rotational speed, and distances
- Includes full set of contact adaptors
- Large angular range simplifies measurement, where straight-line access is difficult



TKRT 31



The TKRT 10 is a well-established entry level model.

The TKRT 21 offers higher performance, such as a greater measuring distance and angle of operation.

TKRT 31 has a wide speed range and a large number of measurement modes, a colour TFT screen and a full set of contact adaptors.



Enclosed parts for contact measurement

TKRT 10

- Adaptor
- Conical tips
- Wheel

TKRT 21

- Adaptor
- Conical tips
- Wheel

TKRT 31

- Adaptor
- Extension shaft
- Conical tips
- Wheels (2 sizes)



Multiple machines

A wide speed range and diversity of measurement modes makes the TKRT series tachometers suitable for monitoring many types of rotating machinery. These include:

- Electric motors
- Conveyors
- Rotary feeders
- Grinders
- Dryers
- Cooling equipment
- Worm wheels
- Elevators

Industrial applications

Some typical industries and areas where these devices can be used include:

- Power plants
- Recycling
- Automotive
- Materials handling
- Food & beverage
- Paper mills

Basic condition monitoring

Technical data	TKRT 10	TKRT 21	TKRT 31
Designation	TKRT 10	TKRT 21	TKRT 31
General			
Memory	10 readings memories	–	Yes, 5 slots
Low battery indicator	Yes	Yes	Yes
Auto switch off	After 15 seconds	Yes	Yes
Display	–	LCD	Multi-line backlight TFT
Display update	–	Continuous	Continuous
Controls	–	Direct selector switches	Direct selector switches
Housing material	–	ABS (plastics)	ABS (plastics)
Measurement			
Optical modes	r/min and Hz	r/min and Hz	r/min and Hz
Contact modes	r/min, metres, inches, yards, feet, per min, Hz	r/min and Hz, meters, feet, inch, per min and per sec	r/min and Hz, meters, feet, inch, per min and per sec
Count modes	Total revs, metres, feet, yards	Distance mode	Distance mode
Speed capture feature	–	Maximum, Minimum or Average rate	Maximum, Minimum or Average rate
Linear speed	0.2 to 1500 metres/min (<i>4 500 ft/min</i>)	Meters, feet, inch, per min and per sec	Meters, feet, inch, per min and per sec
Optical measurement			
Rotational speed range	3 to 99 999 r/min	1 to 99 999 r/min	1 to 99 999 r/min
Accuracy	± 0.05% of reading ± 1 digit	± 0.01% of reading ± 1 digit	± 0.01% of reading ± 1 digit
Measuring distance	50 to 500 mm (<i>1.9 to 19.7 in</i>)	25 to 1200 mm (<i>1 to 47 in</i>)	25 to 1200 mm (<i>1 to 47 in</i>)
Angle of operation	± 45°	± 30°	± 30°
Laser sensor	Built-in class 2 laser	Built-in class 2 laser	Built-in class 2 laser
Contact measurement			
Rotational speed range	2 to 20 000 r/min	Max. 20 000 r/min for 36 000 sec	Max. 20 000 r/min for 36 000 sec
Accuracy	± 1% of reading ± 1 digit	± 0.1% of reading ± 1 digit (> 120 r/min)	± 0.1% of reading ± 1 digit (> 120 r/min or "high accuracy") "low speed accuracy" at < 120 r/min
Contact adaptors	Included with conical tip, conical recess and wheel	Included with removable cones and wheel	Included with removable cones and wheels
Battery and power			
Power source	1x 9V alkaline type IEC 6F22	2 x AA batteries, rechargeable can be used	2 x AA batteries, rechargeable can be used
Run time ca.	12 hours continuous use	50% Laser-On: 12:00 h	20% Display brightness, 50% Laser-On, 50% Bluetooth-On: 8:00 h 100% Display brightness, 50% Laser-On, 50% Bluetooth-On: 3:30 h
Additional power source	6 V DC port (charger not included)	–	–
Size and weight			
Product dimensions	160 × 60 × 42 mm (<i>6.3 × 2.4 × 1.7 in</i>)	295 × 70 × 38 mm (<i>11.6 × 2.8 × 1.5 in</i>)	295 × 70 × 38 mm (<i>11.6 × 2.8 × 1.5 in</i>)
Case dimensions	260 × 85 × 180 mm (<i>10.2 × 3.4 × 7.0 in</i>)	260 × 85 × 180 mm (<i>10.2 × 3.4 × 7.0 in</i>)	260 × 85 × 180 mm (<i>10.2 × 3.4 × 7.0 in</i>)
Unit weight	160 g (<i>0.35 lbs</i>)	270g (<i>0.6 lb</i>)	270g (<i>0.6 lb</i>)
Total weight (incl. case)	680 g (<i>1.5 lbs</i>)	850g (<i>1.9 lb</i>)	850g (<i>1.9 lb</i>)
Operating requirements			
Operating temperature	0 to 50 °C (<i>32 to 122 °F</i>)	0 to 40 °C (<i>32 to 104 °F</i>)	0 to 40 °C (<i>32 to 104 °F</i>)
Storage temperature	- 10 to 50 °C (<i>14 to 122 °F</i>)	-20 to 45 °C (<i>-4 to 113 °F</i>)	-20 to 45 °C (<i>-4 to 113 °F</i>)
Type of protection for indication only	IP 40	IP 40	IP 40
Case contents	1 × Tachometer TKRT 10 1 × Set of 3 × contact adaptors 1 × 9V battery 1 × Set of reflective tape 1 × Instructions for use	1 × Tachometer TKRT 21 2 × Conical tips 1 × Wheel 2 × AA batteries 1 × Set of reflective tape 1 × Instructions for use	1 × Tachometer TKRT 31 1 × Extension shaft 2 × Conical tips 2 × Wheels 2 × AA batteries 1 × Set of reflective tape 1 × Instructions for use

Quick and easy detection of air leaks

Ultrasonic leak detector TKSU 10

The SKF TKSU 10 is an ultrasonic leak detector that helps users to quickly find leakages in compressed air or vacuum systems. The instrument is very simple to use and features adjustable sensitivity and intuitive guidance for superior leak detection results. Any compressed air system can experience leaks, which amplify the load on compressors and increase costs.



Sensor bandwidth
35 to 42 kHz

The TKSU 10 helps users to easily find leaks from a distance, even in noisy industrial environments, via its ultrasound measurement sensor. The built-in LED display assists the user in adjusting sensitivity and shows the measured ultrasound noise from leaking air, allowing the quantification of leaks and prioritization of repairs.

- Easy to use; no training required
- Leak detection from a distance in noisy industrial environments
- Color LED display assists in adjusting sensitivity settings and shows measurement values
- Reduces energy and maintenance costs via leak identification and repair
- Lightweight, handheld device with industrial headset included
- Independently adjustable sensor sensitivity and headset volume
- Flexible probe helps find leaks in difficult-to-access locations

The TKSU 10 is designed for use in all industries utilizing compressed air, and it is particularly recommended for paper and chemical industries, as well as workshops with air-driven power tools.



Headset features neck-band design to wear with protective helmet



Technical data

Designation	TKSU 10
Keyboard	5 function keys
Measuring range	-6 to 99.9 dB μ V (reference 0 dB = 1 μ V)
Resolution	0.1 dB μ V
Amplification	5 adjustable positions in steps of 6 dB
Maximum output	+83 dB SPL with supplied headset
Headset	25 dB NRR Peltor HQ headset
Battery	2 AA batteries
Battery life	7 hours
Operating temperature	-10 to +50 °C (14 to 122 °F)
IP rating	IP42
Flexible rod length	445 mm (17.51 in.)
Carrying case dimensions	530 × 110 × 360 mm (20.9 × 4.3 × 14.2 in.)
Total weight (incl. case)	3 kg (6.6 lbs)

Basic condition monitoring

High-performance, hand-held stroboscopes for visual inspection

Stroboscopes

SKF offers a wide range of portable TKRS stroboscopes for visual inspection of running machines in challenging industrial environments. These portable tools provide early detection of abnormalities to help schedule maintenance tasks and reduce additional loads on rotating equipment in order to reach planned performance levels. Designed for ease of use, the four TKRS models offer from 3 to 118 ultra-bright LEDs. Each stroboscope features a large screen and multifunctional selector switch to help you quickly navigate to the correct menu. Brightness and performance levels are adjustable.

TKRS 11

- Quick speed selection with rotary button
- Black and white LCD display
- Three ultra-bright LEDs



TKRS 21

- High luminescence with seven ultra-bright LEDs
- Multi-line backlit TFT



TKRS 31

- Built-in laser tachometer with flash synchronization
- Pro-mode with additional features like slow motion phase shift
- Trigger input and output with signal modification



TKRS 41

- Extreme luminescence with 118 ultra-bright LEDs
- Portable operation with built-in rechargeable battery
- Continuous operation for long term inspection with power adapter
- Flash synchronization from laser tachometer or trigger input



General benefits of TKRS series:

- Intuitive operation for fast and easy inspection jobs
- Ergonomic and robust design for portable usage in industrial environments
- Bright LEDs with long lifetime and continuous operation
- Tripod mount for stationary inspection

Applications and industries:

- **General industry** – Inspection of fans, gears, belts, chains, couplings, shafts, etc.
- **Paper** – Quality control
- **Textile** – Setup/Inspection of production processes, especially spindles and weaving patterns
- **Printing** – Quality control
- **Test equipment** – Analysis of materials and components during fast movements, including component behavior under vibration or resonance frequency tests

Technical data

Designation	TKRS 11	TKRS 21	TKRS 31	TKRS 41
Light Power	>2 000 Lux at 3° flash duration and 0.3 m (12 in.) distance	>6 200 Lux for at 3° flash duration and 0.3 m (12 in.) distance	>5 600 Lux at 3° flash duration and 0.3 m (12 in.) distance	8 000 lux at 1° flash duration and 0.3 m (12 in.) distance
Brightness (flash duration)	adjustable, 0.2°–5.0°	adjustable, 0.2°–5.0°	adjustable, 0.2°–5.0°	adjustable, 0.025° – 3.0°
Accuracy	±0.02% (±1 digit / ±0.025 μs) whichever is greater	±0.02% (±1 digit / ±0.025 μs) whichever is greater	±0.02% (±1 digit / ±0.025 μs) whichever is greater	±0.02% (±1 digit / ±0.025 μs) whichever is greater
Laser speed measurement	No	No	Yes	Yes
Phase shift	Yes	Yes	Yes with slow motion function	Yes with slow motion function
Run time ca.	ca. 5:30 h at 1° (100% display brightness) ca. 7:45 h at 0.2° (20% display brightness)	ca. 3:00 h at 1° (100% display brightness) ca. 6:45 h at 0.2° (20% display brightness)	ca. 3:45 h at 1° (100% display brightness) ca. 8:15 h at 0.2° (20% display brightness)	ca. 2:30 h at 0.50° (~4000 lux) ca. 5:00 h at 0.25° (~2000 lux)
Display	Black and White LCD	Multi-line backlight TFT	Multi-line backlight TFT	Multi-line backlight LCD
Power source	3 x AA batteries (included)	3 x AA batteries (included)	3 x AA batteries (included)	internal Li-ion battery (rechargeable); continuous operation with power adapter (included)
Power adapter and charger	N/A	N/A	N/A	110-230 V, 50/60 Hz, EU/US/UK/AUS plugs
External trigger range	N/A	N/A	30 to 300 000 f/min	0 to 300 000 f/min
External trigger connection	N/A	N/A	Plug: 3.5 mm TRS plug (included) Input: 3 - 30 V / max. 5 mA (NPN) Output: up to 30 V / max 50 mA (NPN)	Plug: 5-pin plug DIN 41524 (included) Input: 3 - 30 V / max. 5 mA (potentialfree optocoupler)
Signal modification	N/A	N/A	Edge selection, Multiplier, Divider, Delay	Edge selection, Multiplier, Divider, Delay
Instrument dimensions	225 × 78 × 50 mm (8.9 × 3 × 2 in.)	225 × 78 × 50 mm (8.9 × 3 × 2 in.)	225 × 78 × 50 mm (8.9 × 3 × 2 in.)	Without rubber protection 150 × 130 × 112 mm (6.0 × 5.1 × 4.4 in.)
Instrument weight (incl. batteries)	0.29 kg (0.64 lb)	0.29 kg (0.64 lb)	0.3 kg (0.65 lb)	1.15 kg (2.53 lb)
Case dimensions	260 × 85 × 180 mm (10.2 × 3.4 × 7.0 in)	260 × 85 × 180 mm (10.2 × 3.4 × 7.0 in)	260 × 85 × 180 mm (10.2 × 3.4 × 7.0 in)	345 × 165 × 270 mm (13.6 × 6.5 × 10.6 in.)
Total weight (case + instrument)	0.78 kg (1.7 lb)	0.78 kg (1.7 lb)	0.79 kg (1.7 lb)	2.4 kg (5.3 lb)

Basic condition monitoring

Monitoring bearing and machine noise to prevent machine failure

Electronic stethoscopes

The TKST series Stethoscopes are high-quality instruments that are used to perform maintenance and repair work. The use of the stethoscopes facilitates the interception of acoustic phenomena on bearings, machines and other rotating parts to prevent failures. Noise from rotating machinery is picked up by a stick probe and transmitted to a sensor. This converts into an electrical signal, which is processed and amplified. The amplified signal is fed to the headset. TKST 21 also has a built-in recorder.

Both TKST 11 and TKST 21 include a headset, two probes (70 and 300 mm), and are supplied complete in a sturdy carrying case. Pre-recorded audio samples of the most common problematic bearing noises are available in the TKST 21. For TKST 11 they are available online. The audio samples allow reliable identification of the possible cause of the noise.

The devices can detect a wide variety of typical problems, such as:

- Damaged bearings
- Valve chatter
- Tappet noise
- Piston slap
- Gear and pump noise

TKST series

- Lightweight and ergonomic design
- One-hand operation
- High quality, noise cancelling headset
- Easily adjustable volume control
- Frequency range of 30 Hz-15 kHz
- Supplied with two probes



TKST 11

- Monochrome LCD display
- Pre-recorded sound samples available online



TKST 21

- Large, backlit colour display
- Recording function
- Built-in pre-recorded sound samples





Features of the Settings menu include: changing the display brightness; auto-off timing; turning the SKF library of sound samples ON or OFF; and switching the volume limiter OFF.

Technical data



Designation	TKST 11	TKST 21
Frequency range	30 Hz– 15 kHz	30 Hz– 15 kHz
Operating temperature	–10 to +45 °C (14 to 113 °F)	–10 to +45 °C (14 to 113 °F)
Output volume	Adjustable in 15 levels	Adjustable in 10 levels
LCD	Black and white display	Color backlit TFT
Sound volume	Up & down	Up, down and mute
Battery low signal	Yes	Yes
Menus and features	-	Live, Recording, Sounds samples, Settings
Maximum recorder output	250 mV	250 mV
Headset	32 ohm (with ear defend-er)	32 ohm (right and left merged)
Auto switch off	Yes, after 5 min.	After 5 or 10 min., or OFF
Battery	2 × AA Alkaline (included)	2 × AA Alkaline (included)
Battery lifetime	30 hours minimum	Minimum 10 hours (con-tinuous use)
Dimensions hand-set	230 x 70 x 38 mm (9 x 2.8 x 1.5 in)	230 x 70 x 38 mm (9 x 2.8 x 1.5 in)
Probe length	70 and 300 mm (2.8 and 11.8 in.)	70 and 300 mm (2.8 and 11.8 in.)
Case dimensions	360 × 110 × 260 mm (14.2 × 4.3 × 10.2 in.)	360 × 110 × 260 mm (14.2 × 4.3 × 10.2 in.)
Weight		
Total	1670 g (3.68 lb)	1670 g (3.68 lb)
Instrument	290 g (0.64 lb)	290 g (0.64 lb)
Headset	290 g (0.64 lb)	290 g (0.64 lb)
Case contents	1 × Instrument 1 × Headset 1 × Probe 70 mm (2.8 in.) 1 × Probe 300 mm (11.8 in.) 2 × AA Alkaline battery 1 × Instructions for use	1 × Instrument 1 × Headset 1 × Probe 70 mm (2.8 in.) 1 × Probe 300 mm (11.8 in.) 2 × AA Alkaline battery 1 × Instructions for use

Basic condition monitoring



Fast and easy inspection with video function

Endoscopes TKES 10 series

SKF Endoscopes are first line inspection tools that can be used for internal inspection of machinery. They help minimise the need to disassemble machinery for inspection, saving time and money. The compact display unit, with 3.5" backlit screen, allows images and video to be saved and recalled, or to be downloaded and shared with others. Three different models cater to most needs and are equipped with powerful variable LED lighting allowing inspections in dark locations.

- High resolution miniature camera, with up to 2× digital zoom, gives a clear and sharp full screen image
- Available with a 1 metre (3.3 ft) insertion tube in three different variants; flexible, semi-rigid or with an articulating tip
- Small tip diameter of 5,8 mm (0.23 in.), with a wide field of view, allows easy access to most applications
- Supplied with a side view adapter allowing inspection of applications such as pipe walls
- Powerful magnets, and a tripod mount on the back of the display unit, allow the display unit to be used "hands free"
- Up to 50 000 photos or 120 minutes of video can be stored on the SD memory card supplied
- Longer flexible and semi-rigid insertion tubes are available as accessories
- Supplied in a sturdy carrying case complete with all necessary cables, universal mains charger and cleaning kit





Photos and videos can be transferred to PC using the provided USB cable.



Technical data

Designation	TKES 10F	TKES 10S	TKES 10A
Insertion tube and light source	Flexible tube	Semi-rigid tube	Tube with an articulating tip
Image sensor	CMOS image sensor	CMOS image sensor	CMOS image sensor
Resolution (H × V)			
Still image (static)	640 × 480 pixels	640 × 480 pixels	320 × 240 pixels
Video (dynamic)	320 × 240 pixels	320 × 240 pixels	320 × 240 pixels
Size tip (insertion tube) diameter	5.8 mm (0.23 in.)	5.8 mm (0.23 in.)	5.8 mm (0.23 in.)
Tube length	1 m (39.4 in.)	1 m (39.4 in.)	1 m (39.4 in.)
Field of view	67°	67°	55°
Depth of field	1.5–6 cm (0.6–2.4 in.)	1.5–6 cm (0.6–2.4 in.)	2–6 cm (0.8–2.4 in.)
Light source	4 White adjustable LED (0–275 Lux/4 cm)	4 White adjustable LED (0–275 Lux/4 cm)	4 White adjustable LED (0–275 Lux/4 cm)
Probe working temperature	–20 to +60 °C (–4 to +140 °F)	–20 to +60 °C (–4 to +140 °F)	–20 to +60 °C (–4 to +140 °F)
Ingress protection level	IP 67	IP 67	IP 67
Carrying case dimensions	360 × 110 × 260 mm (14.2 × 4.3 × 10.2 in)	360 × 110 × 260 mm (14.2 × 4.3 × 10.2 in)	530 × 110 × 360 mm (20.9 × 4.3 × 14.2 in)



Technical data

Display Unit

Power	5 V DC
Display	3.5" TFT LCD monitor 320 × 240 pixels
Interface	Mini USB 1.1 / AV out / AV in/
Battery (not user serviceable)	Rechargeable Li-Polymer battery (3.7 V). Typically 4 hours operation after a 2 hour charge.
Video out format	NTSC & PAL
Recording medium	SD card 2 GB supplied – storage capacity ±50 000 photos, or 120 minutes video. (SD/SDHC cards up to 32 GB can be used)
Output resolution (H × V)	
Still image (JPEG)	640 × 480 pixels
Video recording format (ASF)	320 × 240 pixels
Temperature range	
Working and storage	–20 to +60 °C (–4 to +140 °F)
Battery charging temperature range	0 to 40 °C (32 to 104 °F)
Functions	Snapshot, video recording, picture & video review on LCD screen, TV Out, transfer of picture & video from SD card to PC

Basic condition monitoring

Unique, reliable and safe method to detect electrical discharges in electric motor bearings

Electrical discharge detector pen TKED 1

The SKF TKED 1 (EDD Pen) is a simple to use hand-held instrument for detecting electrical discharges in electric motor bearings. Electrical discharges are a result of motor shaft voltages discharging to earth through the bearing, causing electrical erosion, lubricant degradation and ultimately bearing failure.



Electric motors are more vulnerable to suffer electrical erosion in bearings when controlled by a Variable Frequency Drive. When incorporated into a predictive maintenance programme, the EDD Pen can help detect bearings more susceptible to failure, and to a significant degree, prevent unplanned machine downtime.

- Unique remote solution allows operation at a distance from the motors. This helps protect the user from touching machinery in motion
- SKF developed technology ¹⁾
- No special training required
- Capable of detecting electrical discharges on a time base of 10 seconds, 30 seconds or infinite
- LED backlit screen, allows use in dark environments
- IP 55 can be used in most industrial environments
- Supplied standard with batteries, a spare antenna and language-free instructions for use in a carrying case



Lubricant degradation caused by electrical discharge currents

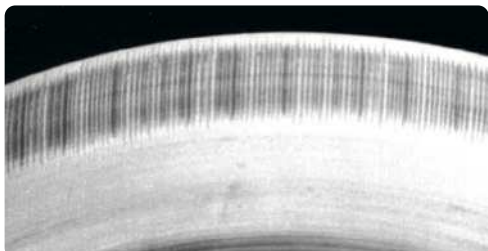

Fluting marks characteristic of electrical erosion in bearings

¹⁾ Patent applied for



Technical data

Designation	TKED 1
Power supply	4.5 V 3 × AAA Alkaline type IEC LR03
Time control pre-sets default	10 or 30 seconds indefinite
Operational and storage temperature	0 to 50 °C (32 to 122 °F) –20 to +70 °C (–4 to +158 °F)
Ingress protection level	IP 55
Display	LCD counter range: 0 to 99 999 discharges. User selectable backlight and low battery warning
Carrying case dimensions	260 × 85 × 180 mm (10.2 × 3.4 × 7.0 in)
Total case and contents weight	0.4 kg (0.88 lb)

Machine monitoring made easy

SKF QuickCollect sensor

The SKF QuickCollect sensor is an easy to use bluetooth enabled handheld sensor that connects to iOS and Android apps on your tablet, smart phone or smart watch (iOS only). Combining vibration and temperature sensing, overall data can be viewed on the spot in real time or pushed to the cloud for future analysis. This SKF QuickCollect sensor is ideal for service, reliability, operations, or maintenance personnel as part of a walk around data collection program.



Features

- Velocity, acceleration enveloping, and temperature measurements
- Bluetooth communication with tablets, smart phones, smart watches
- Easy to use sensor and apps
- Easy to understand indications of machine condition
- Rugged industrial design – Drop test 1.8 m (6 ft.), water and dust resistant (IP65)
- Rechargeable lithium battery (full working day in normal usage)
- Option to connect, store and share data on the Cloud
- Option to connect directly to SKF Remote Diagnostic Services
- Apps for both iOS and Android devices
- Approved to be used in hazardous areas, ATEX, IECEx and CSA Class I Zone

Benefits

- Gets you started quickly
- Can be used with minimum training and experience
- Identify developing rotating machinery issues before they become problems
- Connect directly to expert advice when you need it
- Expand functionality via apps to grow and compliment your existing maintenance program



Measurement displays

Measurements taken by the sensor are shown on your mobile device, which displays velocity, enveloped acceleration and temperature as shown below:



Controls and indicators

1. Power button – Powers the sensor on and off.
2. Battery LED – (Green, Red) Indicates status of battery charge
3. Communication LED – (Green, Red) Indicates whether the sensor is connected to an app. Also indicates when firmware updates are in progress.
4. All purpose check LED – (Green, Red, Amber) Indicates error conditions

For more information see publication PUB CM/P2 17198/3





The right lubricant,
in the right
amount, reaches
the right point at
the right time using
the right method.

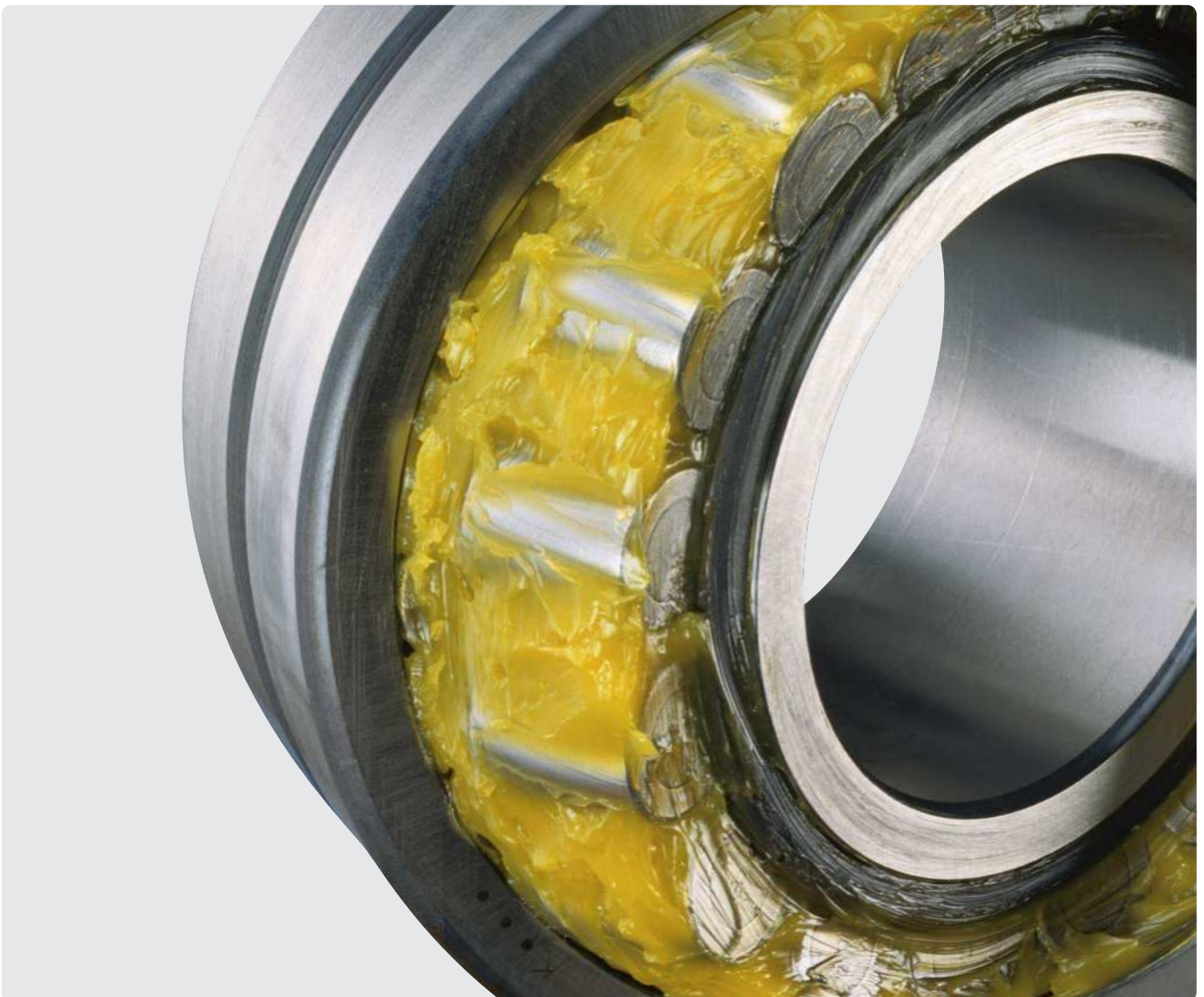

Lubrication

Lubricants	130
Bearing greases	144
Food grade lubricants	162
Special lubricants	168
Automatic grease dispensing tools	174
Manual grease dispensing tools	192
Accessories	198
Oil inspection and dispensing	203
Storage tools.	206
Lubrication analysis tools	208
Lubrication software	210

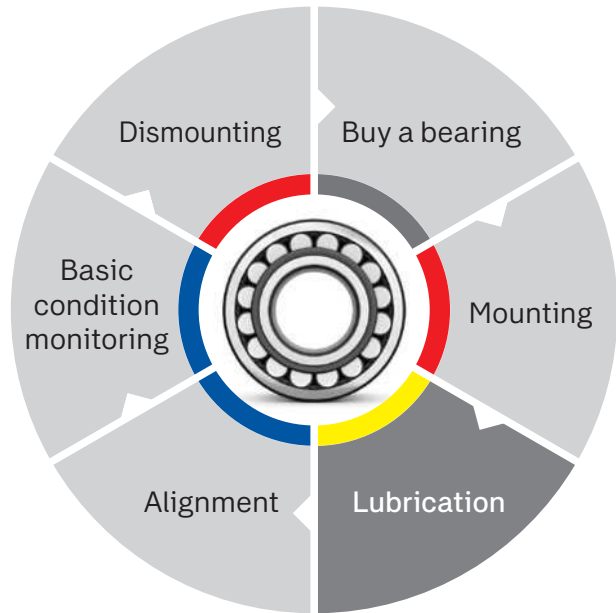

Lubricants

Lubrication management	130
Understanding grease technical data	132
Lubricant selection	138
Technical data.	141

Bearing greases

– LGMT 2	144
– LGMT 3	145
– LGEP 2	146
– LGNL 2	147
– LGNL 3	148
– LGWA 2	149
– LGGB 2	150
– LGLT 2	151
– LGWM 1	152
– LGEP 1	153
– LGWM 2	154
– LGEM 2	155
– LGEV 2	156
– LGHB 2	157
– LGHC 2	158
– LGHP 2	159
– LGHQ 2	160
– LGET 2	161

Food grade lubricants

– LGFG 2	163
– LGFQ 2	164
– LGED 2	165
– LFFM 100.	166
– LFFT 220.	166
– LDTS 1	167

Special lubricants

– LMCG 1	168
– LGTE 2	169
– LGCC 1	170
– LGLS 0	171
– LGLS 2	172
– LHMT 68	173
– LHHT 250	173

Automatic grease dispensing tools

LAGD series	176
TLSD series	178
TLSD 1-DK	180
TLDD Series	182
TLRD series	185
TLMR series	186
Multipoint automatic lubricators TLMP series	188
Accessories	190

Manual grease dispensing tools

Grease guns	192
Battery driven grease gun TLGB 21.	194
Battery driven grease gun TLGB 1262-E.	196
Battery driven grease gun TLGB 1886-E.	197

Accessories

Grease meter LAGM 1000E	198
Grease filler pumps LAGF series	198
Grease pumps LAGG series	199
Bearing packer VKN 550.	200
Grease nozzles LAGS 8.	200
Grease nipples LAGN 120	200
Grease coupler LAGC S	201
Grease fitting caps and tags TLAC 50	201
Ultrasound lubrication checker TLGU 10	202

Oil inspection and dispensing

Oil levellers LAHD series.	203
Oil handling containers LAOS series	204

Storage tools

Oil conditioning station	206
------------------------------------	-----

Lubrication analysis tools

Grease test kit TKG 1	208
Oil check monitor TMEH 1	209

Lubrication software

LubeSelect for SKF greases.	210
SKF Lubrication planner.	210
SKF DialSet	211

Lubrication management

Poor lubrication accounts for more than 36% of premature bearing failures

Include contamination, and this number rises to well above 50%.

The importance of proper lubrication and cleanliness is self-evident in the determination of bearing life.



From lubrication to lubrication management

A good lubrication programme can be defined by applying the 5R approach:

“The right lubricant, in the right amount, reaches the right point at the right time using the right method”

This simple and logical approach, however, requires a detailed action plan that must include aspects as varied as:

- Logistics and supply chain
- Lubricant selection
- Lubricant storage, transfer and dispensing
- Lubrication tasks planning and scheduling
- Lubricant application procedures
- Lubricant analysis and condition monitoring
- Lubricant disposal
- Training

What the right lubrication programme can do for you



Increase

- Productivity
- Reliability
- Availability and durability
- Machine uptime
- Service intervals
- Safety
- Health
- Sustainability

Reduce

- Energy consumption due to friction
- Heat generation due to friction
- Wear due to friction
- Noise due to friction
- Downtime
- Operating expenses
- Product contamination
- Maintenance and repair costs
- Lubricant consumption
- Corrosion



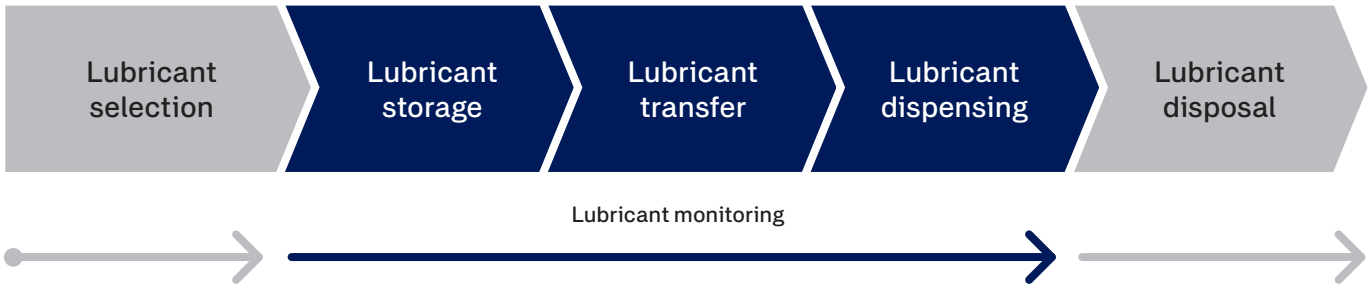

Selecting a suitable grease for a particular bearing is a crucial step if the bearing is to meet design expectations in its application. Use SKF LubeSelect to select the right lubricant for your application.

During storage, maintenance and transfer steps, the lubricant can easily get contaminated due to lack of lubrication knowledge or simply lack of attention. To minimize the risks of lubricant contamination in storage and transfer, we recommend the use of the Oil storage stations and Oil handling containers LAOS series. For the transfer of greases, we offer an extensive range of Grease pumps, Grease filler pumps and the Bearing packer.

For the correct lubricant dispensing, consider the range of Grease guns and the range of single and multi point lubricators. SKF DialSet helps you select the right lubricator settings for the application.

For the monitoring of the lubricant, SKF offers the following tools: Oil levellers, Oil check monitor and Grease test kit.

Lubricant disposal must be done according to local applicable regulations.

Lubrication management

Just as asset management takes maintenance to a higher level, a lubrication management approach allows lubrication to be seen from a wider point of view. This approach helps to effectively increase machine reliability at a lower overall cost.

SKF Lubrication Management process

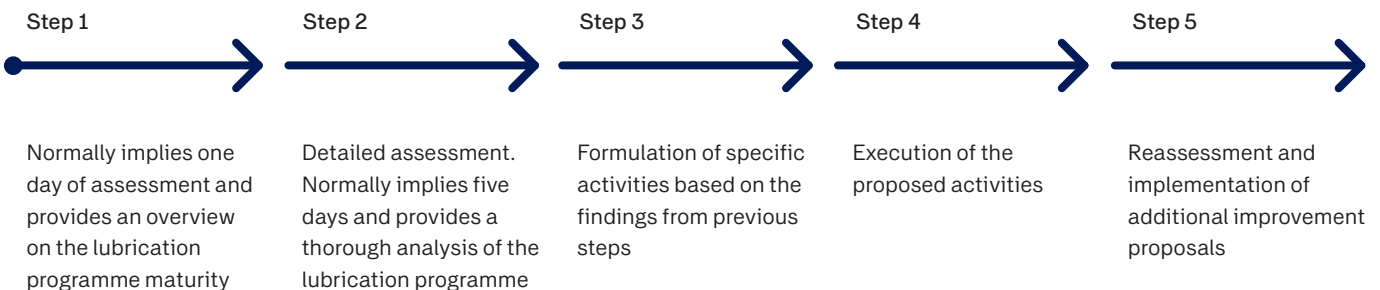

Bearing greases

Understanding grease technical data

Some basic knowledge is required to understand the technical data so that you can select the proper grease. This is an excerpt of the main terms mentioned in SKF grease technical data.

Consistency

A measure of the stiffness of a grease. A proper consistency must ensure that the grease stays in the bearing without generating too much friction. It is classified according to a scale developed by the NLGI (National Lubricating Grease Institute). The softer the grease, the lower the number. Grease for bearings are typically NLGI 1, 2 or 3. The test measures how deep a cone falls into a grease sample in tenths of mm.

NLGI number	ASTM worked penetration (10 ⁻¹ mm)	Appearance at room temperature
000	445–475	very fluid
00	400–430	fluid
0	355–385	semi-fluid
1	310–340	very soft
2	265–295	soft
3	220–250	medium hard
4	175–205	hard
5	130–160	very hard
6	85–115	extremely hard

Temperature range

Comprehends the suitable working range of the grease. It goes between the low temperature limit (LTL) and the high temperature performance limit (HTPL). LTL is defined as the lowest temperature at which the grease will allow the bearing to be started up without difficulty. Below this limit, starvation will occur and cause a failure. Above HTPL, the grease will degrade in an uncontrolled way so that grease life cannot be determined accurately. The traffic light concept illustrates these concepts.

Dropping point

Temperature at which a grease sample, when heated, will begin to flow through an opening according to DIN ISO 2176. It is important to understand that this point is considered to have limited significance for performance of the grease as it is always far above HTPL.

Viscosity

A measure of a fluid's resistance to flow. For lubricants, a proper viscosity must guarantee an adequate separation between surfaces without causing too much friction. According to ISO standards, it is measured at 40 °C (105 °F), as viscosity changes with temperature. Values at 100 °C (210 °F) allow calculation of the viscosity index, e.g. how much the viscosity will decrease when temperature rises.

Mechanical stability

The consistency of bearing greases should not significantly change during its working life. Three main tests are normally used to analyse this behaviour:

- **Prolonged penetration**

The grease sample is subjected to 100 000 strokes in a device called a grease worker. Then, the penetration is measured. The difference against penetration at 60 strokes is reported as the change in 10⁻¹ mm.

- **Roll stability**

A grease sample is placed in a cylinder with a roller inside. The cylinder is then rotated for 72 or 100 hours at 80 or 100 °C (175 or 210 °F) (the standard test demands just 2 hours at room temperature). At the end of the test period, once the cylinder has cooled to room temperature, the penetration of the grease is measured and the change in consistency is reported in 10⁻¹ mm.

- **V2F test**

A railway axlebox is subjected to vibration shocks of 1 Hz from a bouncing hammer producing an acceleration level between 12–15 g. After 72 hours at 500 r/min., the grease leaked from the housing through the labyrinth seal is collected in a tray. If it weighs less than 50 g, a rating of 'm' is granted, otherwise it is rated as 'fail'. Afterwards, the test is continued for another 72 hours at 1 000 r/min. If less than 150 grams of grease leaked after completion of both tests, then a rating of 'M' is given.

V2F grease test rig



Corrosion protection

Corrosive environments demand special properties for rolling bearing greases. During the Emcor test, bearings are lubricated with a mixture of grease and distilled water. At the end of the test, a value between 0 (no corrosion) and 5 (very severe corrosion) is given. Salt water, instead of distilled water or continuous water flow (washout test), can be used to make the test more severe.

Roll stability test rig



Water resistance

A glass strip is coated with the candidate grease, which is placed into a water-filled test tube. The test tube is immersed in a water bath for three hours at a specified test temperature. The change in the grease is visually evaluated and reported as a value between 0 (no change) and 3 (major change) along with the test temperature.

Emcor grease test rig



Oil separation

Lubricating greases release oil when stored for long periods of time or when used in bearings as a function of temperature. The degree of oil separation will depend upon the thickener, base oil and manufacturing method. In the test, a cup is filled with a given quantity of grease (and is weighed before the test) and a 100 gram weight is placed on top of the grease. The complete unit is placed into an oven at 40 °C (105 °F) for one week. At the end of the week, the amount of oil which has leaked through the sieve, is weighed and reported as a percentage of weight loss. A delicate assessment of the oil bleeding has to be made for a given application. Too low values could lead to starvation, while excessive bleeding could generate leakage.

Water resistance test

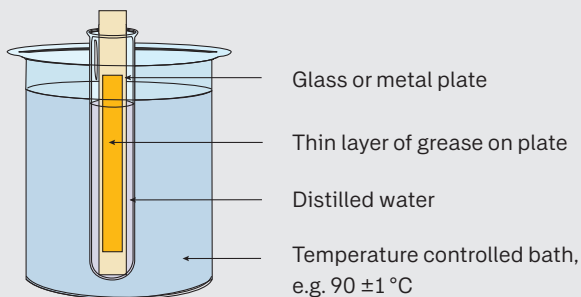

Oil separation test

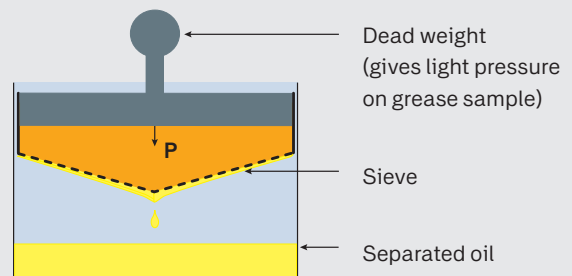

Bearing greases

R2F grease test rig

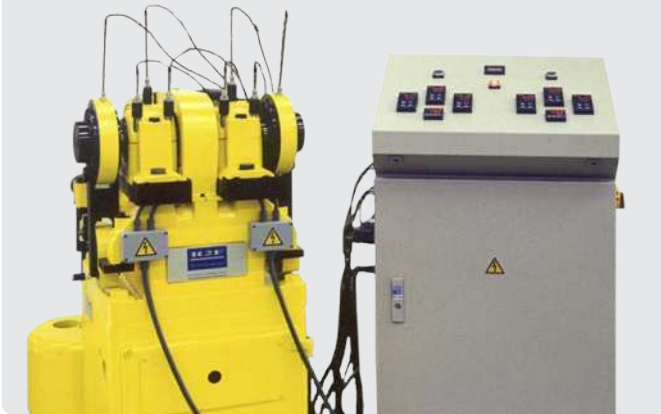

Lubrication ability

The R2F test assesses the high temperature performance and lubricating ability of a grease. A shaft with two spherical roller bearings in their respective housings is driven by an electric motor. The bearings are run under load, the speed may be varied and heat can be applied. The test method is carried out under two different conditions after which the wear of the rollers and the cage is measured. Test A is conducted at ambient temperature and a “pass” rating means that the grease can be used to lubricate large bearings at normal operating temperatures and also in low vibrating applications. Test B runs at 120 °C (250 °F) and a “pass” rating indicates suitability for large bearings at high temperatures.

Copper corrosion

Lubricating greases should protect copper alloys used in bearings from corrosive attack while in service. To assess these properties, a copper strip is immersed in the grease sample and placed in an oven. The strip is then cleaned and the degradation is observed. The result is rated by a numerical system and a rating above 2 indicates poor protection.

Rolling bearing grease life

The ROF and ROF+ tests determine the grease life and its high temperature performance limit (HTPL). Ten deep groove ball bearings are fitted into five housings and filled with a given quantity of grease. The test is undertaken at a pre-determined speed and temperature. Axial and radial loads are applied and the bearings run to failure. The time to failure is recorded in hours and a Weibull life calculation is made to establish the grease life. This information can then be used to determine re-lubrication intervals in an application.

ROF+ grease test rig



Extreme pressure (EP) performance

The 4-ball weld load test rig uses three steel balls held in a cup. A fourth ball is rotated against the three balls at a given speed. A starting load is applied and increased at pre-determined intervals until the rotating ball seizes and welds to the stationary balls. Values above 2 600 N are typically expected in EP grease. Under the 4-ball wear scar test, SKF applies 1 400 N (standard test uses 400 N) on the fourth ball during 1 minute. The wear on the three balls is measured and values below 2 mm are considered as appropriate values for EP greases.

Fretting corrosion

Vibrating or oscillating conditions are typical causes for fretting corrosion. Tests like ASTM D7594, ASTM D4170, or SNR FEB 2 help to understand the properties of lubricating greases in this field.

Low temperature torque

The grease is applied to a test ball bearing in a vertical spindle surrounded by a cooling jacket and submitted to axial load. Two measurements are taken: the torque required to initiate the rotation and the torque required to maintain it. Typically, 1000 mNm and 100 nMn are taken as the limits to define LTTL.

SKF Traffic light concept

The temperature range over which a grease can be used depends mainly on the type of base oil, thickener, and additives, but also on the bearing type. The relevant temperature limits are illustrated schematically using traffic light colours. In the green zone, you can predict the grease life. The amber zones indicate temperature ranges where more careful considerations are required. At temperatures in the red zone, there is a risk of losing the required grease properties or bearing damage.

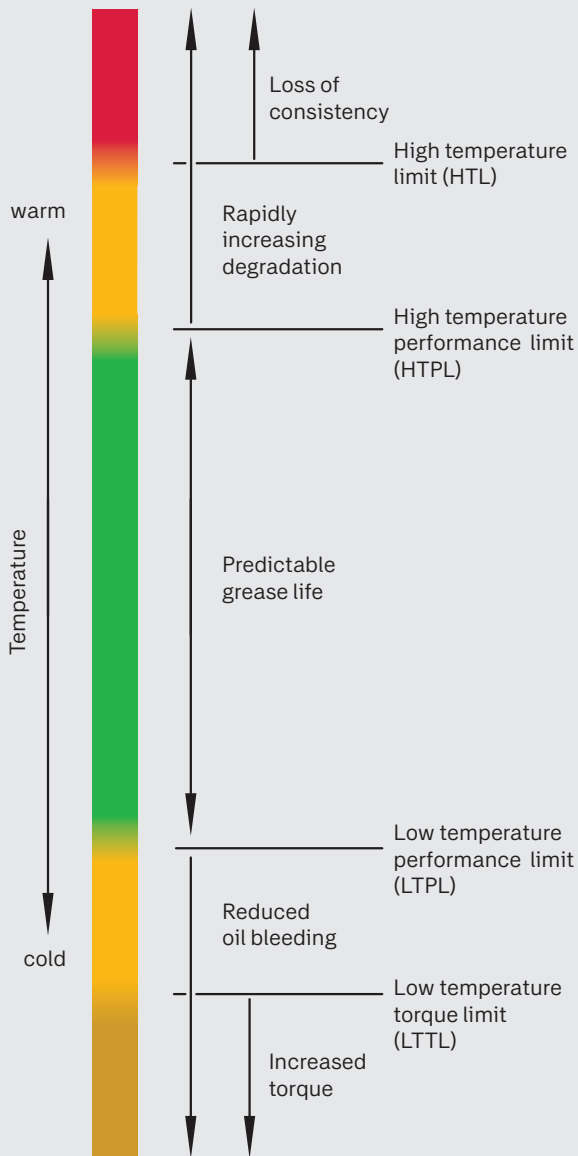

Operating temperature range of SKF greases

When evaluating the suitability of a grease for a certain temperature range, keep in mind that greases typically do not change their properties suddenly at a temperature limit. There is always a transition zone.

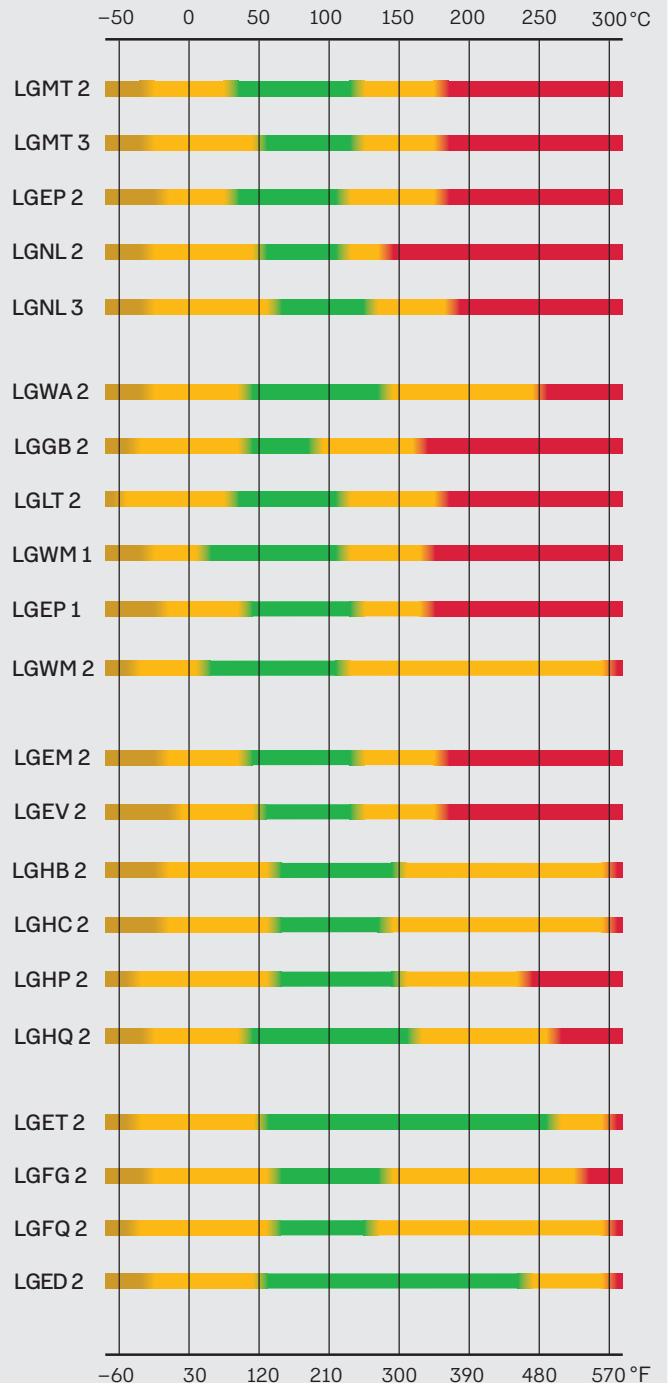

Bearing greases

SKF lubricants offer major competitive advantages:

- Designed and tested to perform under real conditions
- Product data include specific test results enabling a better selection
- Strict quality control of every production batch helps ensure consistent performance
- Quality control allows SKF to offer a five-year shelf-life¹⁾ from the date of production

Production processes and raw materials greatly influence grease properties and performance. It is virtually impossible to select or compare greases based only on their composition. Therefore, performance tests are needed to provide crucial information. In over 100 years, SKF has accrued vast knowledge about the interaction of lubricants, materials and surfaces.

This knowledge has led SKF, in many cases, to set industry standards in bearing lubricant testing. Emcor, ROF, ROF+, V2F, R2F and Bequiet are just some of the multiple tests developed by SKF to assess the performance of lubricants under bearing operating conditions. Many of them are widely used by lubricant manufacturers worldwide.

¹⁾ SKF food grade and biodegradable lubricants offer a two-year shelf-life from the date of production.



SKF Engineering and Research Centre in the Netherlands

Grease compatibility

When a given lubricating grease is intended to be replaced by another one in a given application, there is always a question about whether or not they are both compatible. But how is compatibility defined? And what is actually evaluated?

In order to declare two greases as “compatible”, they are mixed in different proportions and the mechanical stability of the different mixtures is evaluated. Evidently, an excess of hardening or softening would lead to a lubrication failure and therefore it is the first parameter to be assessed. Additional parameters as dropping point are included in the standard method ASTM D6185.

The key point to be understood is that, although two greases might not suffer drastic consistency changes when mixed, no assessment is done on the performance of the mixture since in general the process of replacing a grease by another one is considered as a transition that is to be executed as fast as possible. In practical terms it means that as much as possible of the old grease is expected to be removed and the relubrication periods are expected to be reduced in order to smooth the process. Additionally, it is virtually impossible to assess the performance of a mixture that will be continuously changing while new relubrication tasks are executed. Therefore, please keep these concepts in mind when using the tables presented in the following page and as general rule try always to remove as much as possible the old grease. In case of doubt or additional mixtures not mentioned in it, please consult an SKF application engineer.



Thickener compatibility chart

	Lithium	Calcium	Sodium	Lithium complex	Calcium complex	Sodium complex	Barium complex	Aluminium complex	Clay (Bentonite)	Common polyurea ¹⁾	Calcium sulphonate complex
Lithium	+	●	-	+	-	●	●	-	●	●	+
Calcium	●	+	●	+	-	●	●	-	●	●	+
Sodium	-	●	+	●	●	+	+	-	●	●	-
Lithium complex	+	+	●	+	+	●	●	+	-	-	+
Calcium complex	-	-	●	+	+	●	-	●	●	+	+
Sodium complex	●	●	+	●	●	+	+	-	-	●	●
Barium complex	●	●	+	●	-	+	+	+	●	●	●
Aluminium complex	-	-	-	+	●	-	+	+	-	●	-
Clay (Bentonite)	●	●	●	-	●	-	●	-	+	●	-
Common polyurea ¹⁾	●	●	●	-	+	●	●	●	●	+	+
Calcium sulphonate complex	+	+	-	+	+	●	●	-	-	+	+

Base oil compatibility chart

	Mineral/PAO	Ester	Polyglycol	Silicone: Methyl	Silicone: Phenyl	Polyphenylether	PFPE
Mineral/PAO	+	+	-	-	+	●	-
Ester	+	+	+	-	+	●	-
Polyglycol	-	+	+	-	-	-	-
Silicone: Methyl	-	-	-	+	+	-	-
Silicone: Phenyl	+	+	-	+	+	+	-
Polyphenyl-ether	●	●	-	-	+	+	-
PFPE	-	-	-	-	-	-	+

¹⁾ SKF LGHP 2 and LGHQ 2 have successfully been tested for compatibility with lithium and lithium complex thickened greases.

+

● = Test required

- = Incompatible

Bearing grease selection chart

Grease	Description	Application examples	Temperature		Speed Range ²⁾	Load Range ²⁾	Base oil	
			LTTL ¹⁾ °C (°F)	HTPL ¹⁾ °C (°F)				
LGMT 2	General purpose industrial	Conveyors, fans, small electric motors	-30 (-20)	120 (250)	M	M	L to M	Min
LGMT 3	General purpose industrial	Vertical shaft, outer ring rotation	-30 (-20)	120 (250)	M	M	L to M	Min
LGEP 2	Extreme pressure	Heavy industrial applications, vibrating screens	-20 (-5)	110 (230)	M	L to M	H	Min
LGNL 2	General purpose, high load	Heavy duty, conveyors, vibrating machinery	-30 (-20)	110 (230)	M	L to M	H	Min
LGNL 3	General purpose, high load	Vertical shaft, vibrating screens	-30 (-20)	130 (265)	M	M	H	Min
LGWA 2	Extreme pressure, wide temperature range	Fans, electric motors	-30 (-20)	140 (285) ³⁾	M to H	L to M	L to H	Min
LGGB 2	Biodegradable, low toxicity	Agriculture, construction, water treatment	-40 (-40)	90 (195)	L to M	L to M	M to H	Ester
LGLT 2	Low temperature, extremely high speed	Machine tool spindles, printing cylinders	-50 (-60)	110 (230)	L to M	M to EH	L	PAO
LGWM 1	Extreme pressure, low temperature	Wind turbine main shaft, heavy duty applications	-30 (-20)	110 (230)	L to M	L to M	H	Min
LGEP 1	Extreme pressure, high viscosity	Wind turbine main shaft, heavy duty applications	-20 (-5)	120 (250)	M	VL to M	H to VH	Min
LGWM 2	High load, wide temperature	Wind turbine main shaft, heavy duty off road or marine applications	-40 (-40)	110 (230)	L to M	L to M	L to H	PAO/Min
LGEM 2	High viscosity with solid lubricants	Jaw crushers, construction machinery, vibrating machinery	-20 (-5)	120 (250)	M	L to M	H to VH	Min
LGEV 2	Extremely high viscosity with solid lubricants	Rotary kilns, high pressure grinding rolls, trunnions, rocker arms	-10 (15)	120 (250)	M	VL to L	H to VH	Min
LGHB 2	High load, high temperature	Classifiers, work rolls and continuous casters, vibrating screens	-20 (-5)	150 (300)	M to H	VL to M	L to VH	Min
LGHC 2	High load, water resistant, high temperature	Classifiers, work rolls and continuous casters, vibrating screens	-20 (-5)	140 (285)	M to H	VL to M	L to VH	Min
LGHP 2	High performance, high temperature	Electric motors, high temperature fans	-40 (-40)	150 (300)	M to H	M to H	L to M	Min
LGHQ 2	Electric motor grease	Electric motors, fans	-30 (-20)	160 (320)	M to H	M to H	L to M	Min
LGET 2	Extreme temperature, extreme condition	Ovens, textile dryers, vacuum pumps	-40 (-40)	260 (500)	VH	L to M	H to VH	PFPE
LGFG 2	General purpose, food grade	Conveyors, wrapping machines, bottling machines	-30 (-20)	140 (285)	M	L to H	L to H	Min
LGFQ 2	High load, food grade	Pellet presses, mixers, centralized lubrication systems	-40 (-40)	130 (265)	L to H	VL to M	L to VH	PAO/Min
LGED 2	High temperature, food grade	Baking, vacuum pumps	-30 (-20)	240 (465)	VH	L to M	H to VH	PFPE

¹⁾ LTTL = low temperature torque limit, HTPL = high temperature performance limit for details, refer to The SKF traffic light concept for grease temperature performance on page 135.

²⁾ Refer to Temperature, Speed, and Load ranges for grease selection on page 135

³⁾ LGWA 2 can withstand peak temperatures of 220 °C (430 °F)

Thickener	NLGI grade	Base oil viscosity		Vertical shaft	Oscillating movements	Severe vibrations	Rust protection	Water resistance	Frequent start-up	
		40 °C mm ² /s	100 °C mm ² /s							
Li	2	110	10	●	●	+	+	+	●	Wide range of applications
Li	3	125	12	++	●	++	+	+	●	
Li	2	200	16	●	●	+	+	+	++	
Ca Anh	2	220	14	●	●	+	+	++	++	
Ca _x	3	105	10	++	●	++	+	++	+	
Lix	2	250	17	●	—	+	+	+	+	
Li-Ca	2	110	18	●	+	—	●	+	+	
Li	2	17	3.8	●	—	--	—	+	●	Low temperatures
Li	1	200	16	--	+	—	+	+	++	
Li-Ca	1	400	25	--	+	—	+	+	++	
CaSx	1-2	80	10	●	++	+	++	++	++	High loads
Li-Ca	2	500	32	+	●	+	+	+	++	
Li-Ca	2	1300	49	●	●	+	+	+	++	
CaSx	2	425	28	●	++	+	++	++	++	High temperatures
CaSx	2	450	31	●	++	+	++	++	++	
PU	2-3	96	10.5	+	—	--	++	++	●	
PU	2	110	12	●	—	--	+	++	+	Food grade
PTFE	2	400	38	●	—	●	—	+	●	
CaSx	2	150	16	●	++	+	+	++	+	
CaSx	1-2	320	30	●	++	●	+	++	++	Food grade
PTFE	2	460	42	●	—	●	—	+	●	

++ = Very suitable

+ = Recommended

● = Suitable

— = Not recommended

-- = Not suitable

Bearing grease selection

Bearing operating parameters				
Temperature range			Load range	Load ratio
	°C	°F		C/P
L = Low	< 50	< 120	VH = Very high	< 2
M = Medium	50 to 100	120 to 210	H = High	~ 4
H = High	> 100	> 210	M = Medium	~ 8
EH = Extremely high	> 150	> 300	L = Low	≥ 15

Speed range	Speed factor		
	Ball bearings	Spherical roller, tapered roller, CARB toroidal roller bearings	Cylindrical roller bearings
	n d _m mm/min		
VL = Very low	< 100 000	< 30 000	< 30 000
L = Low	< 300 000	< 75 000	< 75 000
M = Medium	< 500 000	≤ 210 000	≤ 270 000
H = High	> 700 000	> 210 000	> 270 000
VH = Very high	> 700 000		
EH = Extremely high	> 700 000		

n = rotational speed [r/min]
d_m = bearing mean diameter [mm]
= 0.5 (d + D)

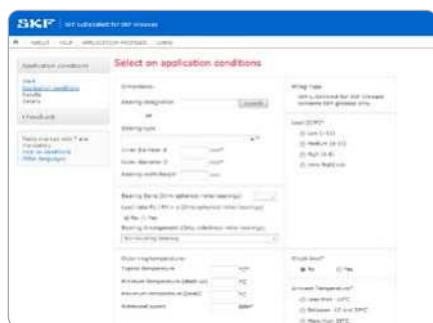

Advanced tool for grease selection and relubrication calculation

LubeSelect for SKF greases

Selecting a suitable grease for a particular bearing is a crucial step if the bearing is to meet design expectations in its application. SKF knowledge about bearing lubrication has been encapsulated into a computer program that can be consulted at skf.com/lubeselect

LubeSelect for SKF greases provides you a user friendly tool to select the right grease and suggest frequency and quantity, while taking into account the particular conditions of your application. General guidelines for typical greases for different applications are also available.



Scan or click the QR code, or go to skf.com/lubeselect

Technical data bearing greases

	LGMT 2	LGMT 3	LGEP 2	LGNL 2	LGNL 3	LGWA 2
DIN 51825 code	K2K-30	K3K-30	KP2G-20	K2KP-30	KP3K-30	KP2N-30
NLGI consistency class	2	3	2	2	3	2
Thickener	Lithium	Lithium	Lithium	Calcium anhydrous	Calcium complex	Lithium complex
Colour	Red brown	Amber	Light brown	Yellow brown	Amber	Amber
Base oil type	Mineral	Mineral	Mineral	Mineral	Mineral	Mineral
Operating temperature range	-30 to +120 °C (-20 to +250 °F)	-30 to +120 °C (-20 to +250 °F)	-20 to +110 °C (-5 to +230 °F)	-30 to +110 °C (-20 to +230 °F)	-30 to +130 °C (-22 to 266 °F)	-30 to +140 °C (-20 to +285 °F)
Dropping point (min), ISO 2176	180 °C (355 °F)	180 °C (355 °F)	180 °C (355 °F)	140 °C (284 °F)	>190 °C (374 °F)	250 °C (480 °F)
Base oil viscosity, DIN 51562 40 °C, mm ² /s 100 °C, mm ² /s	110 10	125 12	200 18	220 14	105 10	250 17
Penetration DIN ISO 2137 Worked, 60 strokes, 10 ⁻¹ mm Prolonged (max.), 100 000 strokes, 10 ⁻¹ mm	265–295 +50	220–250 280	265–295 +50	265–295 +50 max.	220–250 +50 (max. 280)	265–295 +50
Mechanical stability Roll stability, ASTM D 1831 (max.) 50 hrs at 80 °C, 10 ⁻¹ mm V2F test, 144 hrs	+50 M	295 M	+50 M	+70 M	+50 (max. 280) M	+50 M
Corrosion protection, Emscor ISO 11007, Distilled water ISO 11007 modified, Water washout ISO 11007 modified, 0.5% NaCl	0–0 0–0 –	0–0 0–0 –	0–0 0–0 –	0–0 0–0 –	0–0 0–0 –	0–0 0–0 –
Water resistance (max.) DIN 51 807/1, 3 hrs at 90 °C	1	1	1	1	2 max.	1
Oil separation DIN 51 817, 40 °C, %	1–6	1–3	2–5	1–5	1–3	1–5
Lubrication ability R2F, test B at 120 °C	Pass	Pass	Pass	Pass	Pass Pass at 140 °C (284 °F)	Pass at 140 °C (284 °F)
Copper corrosion (max.) DIN 51811 / ASTM D4048, 24 hrs at 100 °C	2 max. at 110 °C (230 °F)	2 max. at 130 °C (265 °F)	2 max. at 110 °C (230 °F)	2 max.	2 max. at 130 °C (266 °F)	2 max.
Grease life (min) ROF test L ₅₀ life, 10 000 r/min, hrs at °C	1 000 at 100 °C (212 °F)	1 000 at 130 °C (265 °F)	1 000 at 110 °C (230 °F)	1 000 at 110 °C (230 °F)	1 000 min. at 130 °C (266 °F)	1 000 at 130 °C (265 °F)
EP performance 4 ball - Wear scar (max.) DIN 51 350, 1 400 N, mm 4 ball - Weld load (min.) DIN 51350/4, N	– –	– –	1.4 2 800	1.8 max. 2 800	2 max. 2 800 min.	1.8 2 600
<i>These characteristics represent typical values.</i>						

Technical data bearing greases

	LGGB 2	LGLT 2	LGWM 1	LGEP 1	LGWM 2	LGEM 2
DIN 51825 code	ISO 12924 ISO-L-XD(L)CEB 2	KHC2G-50	KP1G-30	KP1K-20	KP2G-40	KPF2K-20
NLGI consistency class	2	2	1	1	1-2	2
Thickener	Lithium/ calcium	Lithium	Lithium	Lithium- Calcium	Calcium sulphonate complex	Lithium/ calcium
Colour	Light brown	Beige	Brown	Beige	Light brown	Black
Base oil type	Ester	PAO	Mineral	Mineral	Mineral/PAO	Mineral
Operating temperature range	-40 to +90 °C (-40 to +195 °F)	-50 to +110 °C (-60 to +230 °F)	-30 to +110 °C (-20 to +230 °F)	-20 to +120 °C (-4 to +240 °F)	-40 to +110 °C (-40 to +230 °F)	-20 to +120 °C (-5 to +250 °F)
Dropping point (min), ISO 2176	165 °C (330 °F)	180 °C (355 °F)	170 °C (340 °F)	170 °C (340 °F)	300 °C (570 °F)	180 °C (355 °F)
Base oil viscosity, DIN 51562 40 °C, mm ² /s 100 °C, mm ² /s	110 18	17 3.8	200 15	400 25	80 10	500 32
Penetration DIN ISO 2137 Worked, 60 strokes, 10 ⁻¹ mm Prolonged (max.), 100 000 strokes, 10 ⁻¹ mm	265-295 +50	265-295 +50	310-340 +50	310-340 +50	280-310 +30	265-295 +50
Mechanical stability Roll stability, ASTM D 1831 (max.) 50 hrs at 80 °C, 10 ⁻¹ mm V2F test, 144 hrs	+70 -	- -	- -	+50 -	+30 -	+50 M
Corrosion protection, Emscor ISO 11007, Distilled water ISO 11007 modified, Water washout ISO 11007 modified, 0.5% NaCl	0-0 0-0 0-0	0-1 - -	0-0 0-0 0-0	0-0 0-0 0-0 (1% NaCl)	0-0 0-0 0-0	0-0 0-0 2-2
Water resistance (max.) DIN 51 807/1, 3 hrs at 90 °C	1	1	1	1	1	1
Oil separation DIN 51 817, 40 °C, %	1-3	1-5	8-13	1-5	1-3 at 60 °C (140 °F)	1-5
Lubrication ability R2F, test B at 120 °C	Pass at 90 °C (195 °F)	-	Pass at 100 °C (210 °F)	Pass at 80 °C (176 °F)	Pass	Pass
Copper corrosion (max.) DIN 51811 / ASTM D4048, 24 hrs at 100 °C	2 max.	1 max.	2 max.	1 max. at 120 °C (250 °F)	2 max.	2 max.
Grease life (min) R0F test L ₅₀ life, 10 000 r/min, hrs at °C	1000 at 90 °C (195 °F)	1 000 at 100 °C (210 °F) and 20 000 r/min.	1000 at 110 °C (230 °F)	1000 at 100 °C (210 °F)	1000 at 110 °C (230 °F)	1000 at 100 °C (210 °F)
EP performance 4 ball - Wear scar (max.) DIN 51 350, 1 400 N, mm 4 ball - Weld load (min.) DIN 51350/4, N	1.8 2 600	- 2 000 min.	1.8 2 800	1.8 3 400	2 4 000	1.2 3 400
<i>These characteristics represent typical values.</i>						

LGEV 2	LGHB 2	LGHC 2	LGHP 2	LGHQ 2	LGET 2	LGFG 2	LGfq 2	LGED 2
KPF2K-10	KP2N-20	KP2N-20	K2N-40	K2P-30	KFK2U-40	KP2N-30	KP1/2K-40	KFK2U-30
2	2	2	2-3	2	2	2	1-2	2
Lithium/ calcium	Calcium sulphonate complex	Complex calcium sulphonate	Polyurea	Polyurea	PTFE	Calcium sulphonate complex	Calcium sulphonate complex	PTFE
Black	Brown	Brown-beige	Blue	Blue	White	Brown	Pale Brown	White
Mineral	Mineral	Mineral	Mineral	Mineral	PFPE	Mineral	PAO/Mineral	PFPE
-10 to +120 °C (15 to 250 °F)	-20 to +150 °C (-5 to +300 °F)	-20 to +140 °C (-5 to +284 °F)	-40 to +150 °C (-40 to +300 °F)	-30 to +160 °C (-2 to +320 °F)	-40 to +260 °C (-40 to +500 °F)	-30 to +140 °C (-2 to +284 °F)	-40 to +130 °C (-40 to +266 °F)	-30 to +240 °C (-2 to +464 °F)
180 °C (355 °F)	300 °C (570 °F)	300 °C (570 °F)	240 °C (465 °F)	260 °C (500 °F)	300 °C (570 °F)	280 °C (536 °F)	300 °C (570 °F)	300 °C (570 °F)
1 300 49	425 28	450 31	96 10.5	110 12	400 38	150 16	320 30	460 42
265-295 +50	265-295 -20 to +50	265-295 +30	245-275 365 max.	265-295 385 max.	265-295 -	265-295 +50 max.	265-295 +30 max.	265-295 30 max.
+50 M	-20 to +50 M	+30 -	365 max. -	385 max. -	+30 max. at 130 °C (265 °F) -	+50 max. -	+30 max -	- -
0-0 0-0 2-2	0-0 0-0 0-0	0-0 - 0-1	0-0 0-0 0-0	0-0 0-1 2-2	1-1 - -	0-0 0-0 0-0	0-0 - 0-0	0-0 - -
1	1	1	1	1	0	1 max.	1 max.	1 max.
1-5	1-3 at 60 °C (140 °F)	1-3 at 60 °C (140 °F)	3 max.	1-3	1-3	1-5	1-3	1-3
Pass, 100 °C (210 °F)	Pass at 140 °C (284 °F)	Pass at 140 °C (284 °F)	Pass at 100 °C (210 °F)	Pass at 100 °C (210 °F)	-	Pass	Pass	-
1 max	2 max. at 150 °C (302 °F)	2 max.	1 max. at 150 °C (300 °F)	2 max.	1 max. at 150 °C (300 °F)	1 max.	2 max.	1 max.
1000 at 100 °C (210 °F)	1 000 at 130 °C (265 °F)	1000 at 110 °C (230 °F)	1 000 at 150 °C (300 °F)	1 000 at 160 °C (302 °F)	1 000 at 220 °C (428 °F)	1 000 at 120 °C (248 °F)	1000 at 120 °C (248 °F)	1 000 at 200 °C (392 °F)
1.2 3 000	2 4 000	1.4 4 000	- -	1 2600	- 8 000 min.	1 max 4000 min.	1.5 max. 3 400 min	- 8 000 min.

Lubricants

LGMT 2

General purpose industrial bearing grease



SKF LGMT 2 is mineral oil based, lithium soap thickened grease with excellent thermal stability within its operating temperature range. This premium quality, general purpose grease is suitable for a wide range of industrial applications.

- Excellent oxidation stability
- Good mechanical stability
- Excellent water resistance and rust inhibiting properties

Typical applications

- Agricultural equipment
- Conveyors
- Small electric motors
- Industrial fans

Available pack sizes

Pack size	Designation
35 g tube	LGMT 2/0.035
200 g tube	LGMT 2/0.2
420 ml cartridge	LGMT 2/0.4
1 kg can	LGMT 2/1
5 kg can	LGMT 2/5
18 kg pail	LGMT 2/18
50 kg drum	LGMT 2/50
180 kg drum	LGMT 2/180



Technical data

Designation	LGMT 2		
DIN 51825 code	K2K-30	Corrosion protection	
NLGI consistency class	2	Emcor:	
Thickener	Lithium	– standard ISO 11007	0–0
Colour	Red brown	– water washout test	0–0
Base oil type	Mineral	Water resistance	
Operating temperature range	–30 to +120 °C (–20 to +250 °F)	DIN 51 807/1, 3 hrs at 90 °C	1 max.
Dropping point DIN ISO 2176	>180 °C (>355 °F)	Oil separation	
Base oil viscosity		DIN 51 817, 7 days at 40 °C, static, %	1–6
40 °C, mm ² /s	110	Lubrication ability	
100 °C, mm ² /s	10	R2F, running test B at 120 °C	Pass
Penetration DIN ISO 2137		Copper corrosion	
60 strokes, 10 ⁻¹ mm	265–295	DIN 51 811	2 max. at 110 °C (230 °F)
100 000 strokes, 10 ⁻¹ mm	+50 max.	Rolling bearing grease life	
Mechanical stability		R0F test, L ₅₀ life at 10 000 r/min., hrs	1 000 min. at 100 °C (212 °F)
Roll stability, 50 hrs at 80 °C, 10 ⁻¹ mm	+50 max.	Shelf life	5 years
V2F test	'M'		

These characteristics represent typical values.

LGMT 3

General purpose industrial bearing grease



SKF LGMT 3 is mineral oil based, lithium soap thickened grease. This premium quality, general purpose grease is suitable for a wide range of industrial applications requiring stiff grease.

- Excellent rust inhibiting properties
- High oxidation stability within its recommended temperature range

Typical applications

- Bearings >100 mm (3.9 in.) shaft size
- Outer bearing ring rotation
- Vertical shaft applications
- Continuous high ambient temperatures >35 °C (95 °F)
- Propeller shafts
- Agricultural equipment
- Large electric motors



Available pack sizes

Pack size	Designation
420 ml cartridge	LGMT 3/0.4
0.5 kg can	LGMT 3/0.5
1 kg can	LGMT 3/1
5 kg can	LGMT 3/5
18 kg pail	LGMT 3/18
50 kg drum	LGMT 3/50
180 kg drum	LGMT 3/180
TLMR	page 172



Technical data

Designation	LGMT 3	
DIN 51825 code	K3K-30	Corrosion protection
NLGI consistency class	3	Emcor: – standard ISO 11007 0–0
Thickener	Lithium	– water washout test 0–0
Colour	Amber	Water resistance
Base oil type	Mineral	DIN 51807/1, 3 hrs at 90 °C 1 max.
Operating temperature range	–30 to +120 °C (–20 to +250 °F)	Oil separation
Dropping point DIN ISO 2176	>180 °C (>355 °F)	DIN 51817, 7 days at 40 °C, static, % 1–3
Base oil viscosity		Lubrication ability
40 °C, mm ² /s	125	R2F, running test B at 120 °C Pass
100 °C, mm ² /s	12	Copper corrosion
Penetration DIN ISO 2137		DIN 51811 2 max. at 130 °C (265 °F)
60 strokes, 10 ⁻¹ mm	220–250	Rolling bearing grease life
100 000 strokes, 10 ⁻¹ mm	280 max.	ROF test, L ₅₀ life at 10 000 r/min., hrs 1 000 min. at 130 °C (265 °F)
Mechanical stability		Shelf life 5 years
Roll stability, 50 hrs at 80 °C, 10 ⁻¹ mm	295 max.	
V2F test	'M'	

These characteristics represent typical values.

Lubricants

LGEP 2

High load, extreme pressure bearing grease



SKF LGEP 2 is mineral oil based, lithium soap thickened grease with extreme pressure additives. This grease provides good lubrication in general applications subjected to harsh conditions and vibrations.

- Excellent mechanical stability
- Extremely good corrosion inhibiting properties
- Excellent EP performance

Typical applications

- Pulp and paper making machines
- Jaw crushers
- Dam gates
- Work roll bearings in steel industry
- Heavy machinery, vibrating screens
- Crane wheels, sheaves
- Slewing bearings

Available pack sizes

Pack size	Designation
420 ml cartridge	LGEP 2/0.4
1 kg can	LGEP 2/1
5 kg can	LGEP 2/5
18 kg pail	LGEP 2/18
50 kg drum	LGEP 2/50
180 kg drum	LGEP 2/180
TLMR	page 172



Technical data

Designation	LGEP 2		
DIN 51825 code	KP2G-20	Corrosion protection	
NLGI consistency class	2	Emcor: – standard ISO 11007	0–0
Thickener	Lithium	– water washout test	0–0
Colour	Light brown	Water resistance	
Base oil type	Mineral	DIN 51 807/1, 3 hrs at 90 °C	1 max.
Operating temperature range	–20 to +110 °C (–5 to +230 °F)	Oil separation	
Dropping point DIN ISO 2176	>180 °C (>355 °F)	DIN 51 817, 7 days at 40 °C, static, %	2–5
Base oil viscosity:		Lubrication ability	
40 °C, mm ² /s	200	R2F, running test B at 120 °C	Pass
100 °C, mm ² /s	18	Copper corrosion	
Penetration DIN ISO 2137		DIN 51 811	2 max. at 110 °C (230 °F)
60 strokes, 10 ⁻¹ mm	265–295	EP performance	
100 000 strokes, 10 ⁻¹ mm	+50 max.	Wear scar DIN 51350/5, 1 400 N, mm	1.4 max
Mechanical stability:		4–ball test, welding load DIN 51350/4, N	2 800 min.
Roll stability, 50 hrs at 80 °C, 10 ⁻¹ mm	+50 max.	Rolling bearing grease life	
V2F test	'M'	ROF test, L ₅₀ life at 10 000 r/min., hrs	1 000 min. at 110 °C (230 °F)
		Shelf life	5 years

These characteristics represent typical values.

LGNL 2

General purpose, high load industrial bearing grease



SKF LGNL 2 is a mineral oil based, anhydrous calcium soap thickened grease suitable for high load applications. This general purpose wide applications grease is an effective alternative for traditional general purpose and extreme pressure lithium based greases.

- Excellent water resistance and corrosion protection
- Good mechanical stability
- Good pumpability
- Excellent wear protection

Typical applications

- Agricultural equipment
- Conveyors
- Vibrating applications
- Mills and crushers



Available pack sizes

Pack size	Designation
420 ml cartridge	LGNL 2/0.4
5 kg can	LGNL 2/5
18 kg pail	LGNL 2/18
180 kg drum	LGNL 2/180



Technical data

Designation	LGNL 2	
DIN 51825 code	K2KP-30	Corrosion protection
NLGI consistency class	2	Emcor: – standard ISO 11007 0–0
Thickener	Anhydrous calcium	– water washout test 0–0
Colour	Yellow brown	Water resistance
Base oil type	Mineral	DIN 51 807/1, 3 hrs at 90 °C 1 max.
Operating temperature range	–30 to +110 °C (–22 to +230 °F)	Oil separation
Dropping point DIN ISO 2176	140 °C (284 °F)	DIN 51 817, 7 days at 40 °C, static, % 1–5
Base oil viscosity:		Lubrication ability
40 °C, mm ² /s	220	R2F, running test B at 120 °C Pass
100 °C, mm ² /s	14	Copper corrosion
Penetration DIN ISO 2137		DIN 51 811 2 max. at 100 °C (212 °F)
60 strokes, 10 ⁻¹ mm	265–295	EP performance
100 000 strokes, 10 ⁻¹ mm	+50 max.	Wear scar DIN 51350/5, 1 400 N, mm 1.8 max
Mechanical stability:		4–ball test, welding load DIN 51350/4, N 2 800 min.
Roll stability, 50 hrs at 80 °C, 10 ⁻¹ mm	+70 max.	Rolling bearing grease life
V2F test	'M'	ROF test, L ₅₀ life at 10 000 r/min., hrs 1 000 min. at 110 °C (230 °F)
		Shelf life 5 years

These characteristics represent typical values.

Lubricants

LGNL 3

General purpose, high load bearing grease



SKF LGNL 3 is a premium general purpose NLGI 3 grease based on a mineral oil with a calcium complex soap. Versatile and designed for a wide variety operating conditions, LGNL 3 ensures optimal performance in many applications, including vertical shafts and applications exposed to high vibrations, aiming to extend equipment life and reducing maintenance costs. This general purpose wide applications grease is an effective alternative to traditional general purpose lithium based greases.

- Excellent load carrying capabilities
- High performance
- Wide temperature range
- Extended relubrication intervals

Typical applications

- Vertical shaft applications
- High load applications
- Vibrating conditions
- Pumps and fans
- Mills and crushers



Available pack sizes

Pack size	Designation
1 kg can	LGNL 3/1
18 kg pail	LGNL 3/18
180 kg drum	LGNL 3/180



Technical data

Designation	LGNL 3		
DIN 51825 code	KP3K-30	Corrosion protection	
NLGI consistency class	3	Emcor: – standard ISO 11007	0–0
Thickener	Calcium complex	– water washout test	0–0
Colour	Amber	Water resistance	
Base oil type	Mineral oil	DIN 51 807/1, 3 hrs at 90 °C	2 max.
Operating temperature range	–30 to +130 °C (–22 to +266 °F)	Oil separation	
Dropping point DIN ISO 2176	190 °C min. (374 °F min.)	DIN 51 817, 7 days at 40 °C, static, %	1–3
Base oil viscosity:		Lubrication ability	
40 °C, mm ² /s	105	R2F, running test B at 120 °C	Pass at 140 °C (284 °F)
100 °C, mm ² /s	10	Copper corrosion	
Penetration DIN ISO 2137		DIN 51 811	2 max. at 130 °C (266 °F)
60 strokes, 10 ⁻¹ mm	220–250	Rolling bearing grease life	
100 000 strokes, 10 ⁻¹ mm	+50	ROF test, L ₅₀ life at 10 000 r/min., hrs	1 000 min. at 130 °C (266 °F)
Mechanical stability:		EP performance	
Roll stability, 50 hrs at 80 °C, 10 ⁻¹ mm	+50	Wear scar DIN 51350/5, 1 400 N, mm	2 max
V2F test	'M'	4–ball test, welding load DIN 51350/4, N	2 800 min.
		Shelf life	5 years

These characteristics represent typical values.

LGWA 2

High load, extreme pressure, wide temperature range bearing grease



SKF LGWA 2 is a premium quality mineral oil based, lithium complex grease with extreme pressure (EP) performance. LGWA 2 is recommended for general industrial applications, when loads or temperatures exceed the range of general purpose greases.

- Excellent lubrication at peak temperatures up to 220 °C (430 °F) for short periods
- Protection of wheel bearings operating under severe conditions
- Effective lubrication in wet conditions
- Good water and corrosion resistance
- Excellent lubrication under high loads and low speeds

Typical applications

- Washing machines
- Fans and electric motors



Available pack sizes

Pack size	Designation
200 g tube	LGWA 2/0.2
420 ml cartridge	LGWA 2/0.4
1 kg can	LGWA 2/1
5 kg can	LGWA 2/5
18 kg pail	LGWA 2/18
50 kg drum	LGWA 2/50
180 kg drum	LGWA 2/180
LAGD, TLSD, TLMR	page 177, 179, 187



Technical data

Designation	LGWA 2		
DIN 51825 code	KP2N-30	Water resistance DIN 51 807/1, 3 hrs at 90 °C	1 max.
NLGI consistency class	2	Corrosion protection Emcor: – standard ISO 11007 – water washout test	0–0 0–0
Thickener	Lithium complex	Oil separation DIN 51 817, 7 days at 40 °C, static, %	1–5
Colour	Amber	Lubrication ability R2F, running test B at 120 °C	Pass at 140 °C (284 °F)
Base oil type	Mineral	Copper corrosion DIN 51 811	2 max. at 100 °C (210 °F)
Operating temperature range	–30 to +140 °C (–20 to +285 °F)	Rolling bearing grease life ROF test, L ₅₀ life at 10 000 r/min., hrs	1 000 min. at 130 °C (265 °F)
Dropping point DIN ISO 2176	>250 °C (>480 °F)	EP performance Wear scar DIN 51350/5, 1 400 N, mm 4–ball test, welding load DIN 51350/4, N	1.8 max. 2 600 min.
Base oil viscosity 40 °C, mm ² /s	250	Shelf life	5 years
100 °C, mm ² /s	17		
Penetration DIN ISO 2137 60 strokes, 10 ^{–1} mm	265–295		
100 000 strokes, 10 ^{–1} mm	+50 max. (325 max.)		
Mechanical stability Roll stability, 50 hrs at 80 °C, 10 ^{–1} mm V2F test	+50 max. change 'M'		

These characteristics represent typical values.

Lubricants

LGGB 2

EAL biodegradable bearing grease



SKF LGGB 2 is an Environmentally Acceptable Lubricant (EAL). Its special formulation makes it most suitable for applications where environmental contamination is a concern. More than a biodegradable grease, an EAL is a lubricant that meets minimum standards for biodegradability, toxicity and bio-accumulation ¹⁾. Therefore, their likelihood of having adverse consequences for the aquatic environment, compared to conventional lubricants is minimized.

- Good performance in applications with steel-on-steel spherical plain bearings, ball bearings and roller bearings
- Good low temperature start-up performance
- Good corrosion inhibiting properties
- Suitable for medium to high loads

Typical applications

- Agricultural and forestry equipment
- Construction and earthmoving equipment
- Mining and conveying equipment
- Water treatment and irrigation
- Locks, dams, bridges
- Linkages, rod ends



Available pack sizes

Pack size	Designation
420 ml cartridge	LGGB 2/0.4
5 kg can	LGGB 2/5
18 kg pail	LGGB 2/18
LAGD	page 177



¹⁾ According to the U.S. Environment Protection Agency's Vessel General Permit (EPA VGP)

Technical data

Designation	LGGB 2	
ISO 12924 code	ISO 12924 ISO-L-XD(L)CEB 2	Corrosion protection Emcor: – standard ISO 11007 0–0 – water washout test 0-0 – salt water test (1% NaCl) 0–0
NLGI consistency class	2	Water resistance DIN 51 807/1, 3 hrs at 90 °C 1
Thickener	Lithium/calcium	Oil separation DIN 51 817, 7 days at 40 °C, static, % 1–3
Colour	Light brown	Lubrication ability R2F, running test B at 120 °C Pass at 90 °C (195 °F)
Base oil type	Ester	Copper corrosion DIN 51 811 2 max. at 100 °C (>210 °F)
Operating temperature range	–40 to +90 °C (–40 to +195 °F)	Rolling bearing grease life R0F test L ₅₀ life at 10 000 r/min., hrs 1 000 at 90 °C (195 °F)
Dropping point DIN ISO 2176	>165 °C (>330 °F)	EP performance Wear scar DIN 51350/5, 1 400 N, mm 1.8 max. 4–ball test, welding load DIN 51350/4, N 2 600 min.
Base oil viscosity		Shelf life 2 years
40 °C, mm ² /s	110	
100 °C, mm ² /s	18	
Penetration DIN ISO 2137		
60 strokes, 10 ^{–1} mm	265–295	
100 000 strokes, 10 ^{–1} mm	+50 max.	
Mechanical stability		
Roll stability, 50 hrs at 80 °C, 10 ^{–1} mm	+70 max.	

These characteristics represent typical values.

LGLT 2

Low temperature, extremely high speed bearing grease



SKF LGLT 2 is a fully synthetic oil based grease using lithium soap. Its unique thickener technology and low viscosity oil (PAO) provide excellent lubrication performance at low temperatures $-50\text{ }^{\circ}\text{C}$ ($-60\text{ }^{\circ}\text{F}$) and extremely high speeds (n_{dm} values of 1.6×10^6 can be reached).

- Low friction torque
- Quiet running
- Extremely good oxidation stability and resistance to water

Typical applications

- Textile spinning spindles
- Machine tool spindles
- Instruments and control equipment
- Small electric motors used in medical and dental equipment
- In-line skates
- Printing cylinders

Available pack sizes

Pack size	Designation
420 ml cartridge	LGLT 2/0.4
0.9 kg can	LGLT 2/1
16 kg pail	LGLT 2/18



Technical data

Designation	LGLT 2		
DIN 51825 code	KHC2G-50	Water resistance DIN 51 807/1, 3 hrs at $90\text{ }^{\circ}\text{C}$	1 max.
NLGI consistency class	2	Oil separation DIN 51 817, 7 days at $40\text{ }^{\circ}\text{C}$, static, %	1-5
Thickener	Lithium	Copper corrosion DIN 51 811	1 max. at $100\text{ }^{\circ}\text{C}$ ($210\text{ }^{\circ}\text{F}$)
Colour	Beige	Rolling bearing grease life R0F test	>1 000,
Base oil type	Synthetic (PAO)	L_{50} life at 10 000 r/min., hrs	20 000 r/min. at $100\text{ }^{\circ}\text{C}$ ($210\text{ }^{\circ}\text{F}$)
Operating temperature range	-50 to $+110\text{ }^{\circ}\text{C}$ (-60 to $+230\text{ }^{\circ}\text{F}$)	EP performance 4-ball test, welding load DIN 51350/4, N	2 000 min.
Dropping point DIN ISO 2176	$>180\text{ }^{\circ}\text{C}$ ($>355\text{ }^{\circ}\text{F}$)	Shelf life	5 years
Base oil viscosity 40 $^{\circ}\text{C}$, mm^2/s	17	<i>These characteristics represent typical values.</i>	
100 $^{\circ}\text{C}$, mm^2/s	3.8		
Penetration DIN ISO 2137 60 strokes, 10^{-1} mm	265–295		
100 000 strokes, 10^{-1} mm	+50 max.		
Corrosion protection Emcor: – standard ISO 11007	0–1		

Lubricants

LGWM 1

Extreme pressure low temperature bearing grease



SKF LGWM 1 is a low consistency mineral oil based grease, using a lithium soap and containing extreme pressure additives. It is extremely suitable for the lubrication of bearings operating under both radial and axial loads.

- Good oil film formation at low temperatures down to $-30\text{ }^{\circ}\text{C}$ ($-20\text{ }^{\circ}\text{F}$)
- Good pumpability down to low temperatures
- Good corrosion protection
- Good water resistance

Typical applications

- Wind turbine main shafts
- Screw conveyors
- Centralised lubrication systems
- Spherical roller thrust bearing applications



Available pack sizes

Pack size	Designation
420 ml cartridge	LGWM 1/0.4
5 kg can	LGWM 1/5
18 kg pail	LGWM 1/18
50 kg drum	LGWM 1/50
180 kg drum	LGWM 1/180
TLMR	page 187



Technical data

Designation	LGWM 1		
DIN 51825 code	KP1G-30	Water resistance DIN 51 807/1, 3 hrs at 90 °C	1 max.
NLGI consistency class	1	Oil separation DIN 51 817, 7 days at 40 °C, static, %	8–13
Thickener	Lithium	Lubrication ability R2F, running test B at 120 °C	Pass at 100 °C (212 °F)
Colour	Brown	Copper corrosion DIN 51 811	2 max. at 100 °C (212 °F)
Base oil type	Mineral	Rolling bearing grease life ROF test L ₅₀ life at 10 000 r/min., hrs	1 000 at 110 °C (230 °F)
Operating temperature range	$-30\text{ to }+110\text{ }^{\circ}\text{C}$ ($-20\text{ to }+230\text{ }^{\circ}\text{F}$)	EP performance Wear scar DIN 51350/5, 1 400 N, mm	1.8 max.
Dropping point DIN ISO 2176	$>170\text{ }^{\circ}\text{C}$ ($>340\text{ }^{\circ}\text{F}$)	4-ball test, welding load DIN 51350/4, N	2 800 min.
Base oil viscosity		Shelf life	5 years
40 °C, mm ² /s	200	<i>These characteristics represent typical values.</i>	
100 °C, mm ² /s	15		
Penetration DIN ISO 2137			
60 strokes, 10 ⁻¹ mm	310–340		
100 000 strokes, 10 ⁻¹ mm	+50 max.		
Corrosion protection:			
Emcor: – standard ISO 11007	0–0		
– water washout test	0–0		
– salt water test (0.5% NaCl)	0-0		

LGEP 1

Extreme pressure bearing grease



SKF LGEP 1 is a high viscosity, low consistency mineral oil based grease, using a lithium-calcium thickener. It is extremely suitable for the lubrication of large bearings subjected to high loads and low speeds. LGEP 1 has been developed to deliver extended maintenance intervals while minimizing downtime.

- Excellent mechanical stability
- Very good protection against fretting and wear
- Good flow at low starting temperature
- Good flow properties that enable easy replenishment within the bearing design
- Low friction characteristics that help to maintain low operating temperatures
- Excellent water resistance and corrosion protection
- Good pumpability

Typical applications

- Wind turbine main shaft bearings
- Large bearing applications
- Heavy industrial applications
- Centralized lubrication systems



Available pack sizes

Pack size	Designation
18 kg pail	LGEP 1/18
180 kg drum	LGEP 1/180

Technical data

Designation	LGEP 1	
DIN 51825 code	KP1K-20	Corrosion protection
NLGI consistency class	1	Emcor: – standard ISO 11007 0–0
Thickener	Lithium-Calcium	– water washout test 0-0
Colour	Beige	– salt water test (1% NaCl) 0–0
Base oil type	Mineral	Water resistance
Operating temperature range	–20 to +120 °C (–4 to +248 °F)	DIN 51 807/1, 3 hrs at 90 °C 1 max.
Dropping point DIN ISO 2176	170 °C min. (338 °F min)	Oil separation
Base oil viscosity		DIN 51 817, 7 days at 40 °C, static, % 1–5
40 °C, mm ² /s	400	Lubrication ability
100 °C, mm ² /s	25	R2F, running test B at 120 °C Pass at 80 °C (176 °F)
Penetration DIN ISO 2137		Copper corrosion
60 strokes, 10 ⁻¹ mm	310–340	DIN 51 811, 120 °C 1 max.
100 000 strokes, 10 ⁻¹ mm	+50 max.	Rolling bearing grease life
Mechanical stability		R0F test, L ₅₀ life at 10 000 r/min., hrs 1 000 min. at 100 °C (212 °F)
Roll stability, 50 hrs at 80 °C, 10 ⁻¹ mm	+50 max.	EP performance
		Wear scar DIN 51350/5, 1 400 N, mm 1.8 max.
		4-ball test, welding load DIN 51350/4. N 3400 min.

These characteristics represent typical values.

Lubricants

LGWM 2

High load, wide temperature bearing grease



SKF LGWM 2 is a synthetic-mineral oil based grease using calcium sulphonate complex thickener. It is suitable for applications subjected to high loads, wet environments and fluctuating temperatures.

- Excellent corrosion protection
- Excellent mechanical stability
- Excellent high load lubricating capacity
- Good false brinelling protection
- Good pumpability down to low temperatures



Typical applications

- Wind turbine mains shafts
- Heavy duty off road applications
- Snow exposed applications
- Marine and offshore applications
- Spherical roller thrust bearing applications

Available pack sizes

Pack size	Designation
420 ml cartridge	LGWM 2/0.4
5 kg can	LGWM 2/5
18 kg pail	LGWM 2/18
50 kg drum	LGWM 2/50
180 kg drum	LGWM 2/180
LAGD, TLMR	page 177, 187



Technical data

Designation	LGWM 2	
DIN 51825 code	KP2G-40	Corrosion protection
NLGI consistency class	1-2	Emcor: – standard ISO 11007 0-0
Thickener	Calcium sulphonate complex	– water washout test 0-0
Colour	Light brown	– salt water test (0.5% NaCl) 0-0
Base oil type	Synthetic (PAO)/ Mineral	Water resistance
Operating temperature range	-40 to +110 °C (-40 to +230 °F)	DIN 51 807/1, 3 hrs at 90 °C 1 max.
Dropping point DIN ISO 2176	>300 °C (>570 °F)	Oil separation
Base oil viscosity		DIN 51 817, 7 days at 40 °C, static, % 1-3 at 60 °C (140 °F)
40 °C, mm ² /s	80	Lubrication ability
100 °C, mm ² /s	10	R2F, running test B at 120 °C (248 °F) Pass
Penetration DIN ISO 2137		Copper corrosion
60 strokes, 10 ⁻¹ mm	280-310	DIN 51 811 2 max. at 100 °C (210 °F)
100 000 strokes, 10 ⁻¹ mm	+30 max.	Rolling bearing grease life
Mechanical stability		R0F test, L ₅₀ life at 10 000 r/min., hrs 1 000 at 110 °C (230 °F)
Roll stability, 50 hrs at 80 °C, 10 ⁻¹ mm	+30 max.	EP performance
		Wear scar DIN 51350/5, 1 400 N, mm 2 max.
		4-ball test, welding load DIN 51350/4, N 4 000 min.
		Shelf life 5 years

These characteristics represent typical values.

LGEM 2

High viscosity bearing grease with solid lubricants



SKF LGEM 2 is a high viscosity, mineral oil based grease using a lithium/calcium soap. Its content of molybdenum disulphide and graphite provides extra protection for harsh applications subjected to high loads, heavy vibrations and slow rotations.

- High oxidation stability
- Molybdenum disulphide and graphite provide lubrication even if the oil film breaks down

Typical applications

- Rolling element bearings running at low speed and very high loads
- Jaw crushers
- Track laying machines
- Lift mast wheels
- Building machines such as mechanical rams, crane arms and crane hooks



Available pack sizes

Pack size	Designation
420 ml cartridge	LGEM 2/0.4
5 kg can	LGEM 2/5
18 kg pail	LGEM 2/18
180 kg drum	LGEM 2/180
LAGD, TLSD	page 177, 187



Technical data

Designation	LGEM 2	
DIN 51825 code	KPF2K-20	Corrosion protection
NLGI consistency class	2	Emcor: – standard ISO 11007 0–0
Thickener	Lithium/calcium	– water washout test 0–0
Colour	Black	Water resistance
Base oil type	Mineral	DIN 51 807/1, 3 hrs at 90 °C 1 max.
Operating temperature range	–20 to +120 °C (–5 to +250 °F)	Oil separation
Dropping point DIN ISO 2176	>180 °C (>355 °F)	DIN 51 817, 7 days at 40 °C, static, % 1–5
Base oil viscosity		Lubrication ability
40 °C, mm ² /s	500	R2F, running test B at 120 °C Pass
100 °C, mm ² /s	32	Copper corrosion
Penetration DIN ISO 2137		DIN 51 811 2 max. at 100 °C (210 °F)
60 strokes, 10 ⁻¹ mm	265–295	Rolling bearing grease life
100 000 strokes, 10 ⁻¹ mm	+50 max.	R0F test, L ₅₀ life at 10 000 r/min., hrs 1 000 min. at 100 °C (212 °F)
Mechanical stability		EP performance
Roll stability, 50 hrs at 80 °C, 10 ⁻¹ mm	+50 max.	Wear scar DIN 51350/5, 1 400 N, mm 1.2 max.
V2F test	'M'	4–ball test, welding load DIN 51350/4, N 3 400 min.
		Shelf life
		5 years

These characteristics represent typical values.

Lubricants

LGEV 2

Extremely high viscosity bearing grease with solid lubricants



SKF LGEV 2 is a mineral oil based grease, using a lithium-calcium soap. Its high content of molybdenum disulphide and graphite, in conjunction with an extremely high viscosity oil, provide outstanding protection under the harshest conditions involving high loads, slow rotations and severe vibrations.

- Extremely suitable for lubricating large sized spherical roller bearings subject to high loads and slow rotations, a situation where microslip is likely to occur
- Extremely mechanically stable providing good corrosion protection

Typical applications

- Trunnion bearings on rotating drums
- Support and thrust rollers on rotary kilns and dryers
- Bucket wheel excavators
- Slewing ring bearings
- High pressure roller mills
- Crushers

Available pack sizes

Pack size	Designation
35 g tube	LGEV 2/0.035
420 ml cartridge	LGEV 2/0.4
5 kg can	LGEV 2/5
18 kg pail	LGEV 2/18
50 kg drum	LGEV 2/50
180 kg drum	LGEV 2/180
TLMR	page 187



Technical data

Designation	LGEV 2	
DIN 51825 code	KPF2K-10	Corrosion protection
NLGI consistency class	2	Emcor: – standard ISO 11007 0–0
Thickener	Lithium/calcium	– water washout test 0–0
Colour	Black	Water resistance
Base oil type	Mineral	DIN 51 807/1, 3 hrs at 90 °C 1 max.
Operating temperature range	–10 to +120 °C (15 to 250 °F)	Oil separation
Dropping point DIN ISO 2176	>180 °C (>355 °F)	DIN 51 817, 7 days at 40 °C, static, % 1–5
Base oil viscosity		Lubrication ability
40 °C, mm ² /s	1 300	R2F, running test B at 120 °C Pass at 100 °C (210 °F)
100 °C, mm ² /s	47.5	Copper corrosion
Penetration DIN ISO 2137		DIN 51 811 1 max. at 100 °C (210 °F)
60 strokes, 10 ⁻¹ mm	265–295	Rolling bearing grease life
100 000 strokes, 10 ⁻¹ mm	+50 max.	R0F test, L ₅₀ life at 10 000 r/min., hrs 1 000 at 100 °C (210 °F)
Mechanical stability		EP performance
Roll stability, 72 hrs at 100 °C, 10 ⁻¹ mm	+50 max.	Wear scar DIN 51350/5, 1 400 N, mm 1.2 max.
V2F test	'M'	4–ball test, welding load DIN 51350/4, N 3 000 min.
		Shelf life
		5 years

These characteristics represent typical values.

LGHB 2

High load, high temperature, high viscosity bearing grease



SKF LGHB 2 is a high viscosity, mineral oil based grease, using calcium sulphonate complex thickener. Formulated to withstand high temperatures and extreme loads, it is suitable for a wide range of applications, especially in the cement, mining and metals segments. It also has very good pumpability properties.

- Excellent load capacity, anti-oxidation and corrosion protection even with large water ingress
- Very good pumpability properties
- Withstands peak temperatures of 200 °C (390 °F)

Typical applications

- Steel on steel plain bearings
- Pulp and paper making machines
- Asphalt vibrating screens
- Continuous casting machines
- Sealed spherical roller bearings operating up to 150 °C (300 °F)
- Work roll bearings in steel industry
- Mast rollers of fork lift trucks
- Slewing bearings

Available pack sizes

Pack size	Designation
420 ml cartridge	LGHB 2/0.4
5 kg can	LGHB 2/5
18 kg pail	LGHB 2/18
50 kg drum	LGHB 2/50
180 kg drum	LGHB 2/180
LAGD, TLSD, TLMR	page 177, 179, 187



Technical data

Designation	LGHB 2		
DIN 51825 code	KP2N-20	Corrosion protection	
NLGI consistency class	2	Emcor: – standard ISO 11007	0–0
Thickener	Calcium sulphonate complex	– water washout test	0–0
Colour	Brown	– salt water test (0.5% NaCl)	0–0
Base oil type	Mineral	Water resistance	
Operating temperature range	–20 to +150 °C (–5 to +300 °F)	DIN 51 807/1, 3 hrs at 90 °C	1 max.
Dropping point DIN ISO 2176	300 °C (572 °F)	Oil separation	
Base oil viscosity		DIN 51 817, 7 days at 40 °C, static, %	1–3 at 60 °C (140 °F)
40 °C, mm ² /s	425	Lubrication ability	
100 °C, mm ² /s	28	R2F, running test B at 120 °C	Pass at 140 °C (285 °F)
Penetration DIN ISO 2137		Copper corrosion	
60 strokes, 10 ⁻¹ mm	265–295	DIN 51 811	2 max. at 150 °C (300 °F)
100 000 strokes, 10 ⁻¹ mm	–20 to +50 max.	Rolling bearing grease life	
Mechanical stability		ROF test, L ₅₀ life at 10 000 r/min., hrs	>1 000 at 130 °C (265 °F)
Roll stability, 50 hrs at 100 °C, 10 ⁻¹ mm	–20 to +50 max.	EP performance	
V2F test	'M'	Wear scar DIN 51350/5, 1 400 N, mm	2 max.
		4–ball test, welding load DIN 51350/4, N	4 000 min.
		Shelf life	5 years

These characteristics represent typical values.

Lubricants

LGHC 2

High load, water resistant, high temperature bearing grease



LGHC 2 is a mineral oil based grease based on calcium sulphonate complex technology. It is formulated to withstand high loads, large amounts of water and high temperatures. It is most suitable for heavy applications, especially in the cement, mining and metals segments.

- Good mechanical stability
- Excellent corrosion protection
- Excellent high load lubricating capacity

Typical applications

- Roll stands in metallurgical industry
- Continuous casters
- Vibrating screens
- Ball mills bearings



Available pack sizes

Pack size	Designation
420 ml cartridge	LGHC 2/0.4
18 kg pail	LGHC 2/18
50 kg drum	LGHC 2/50
180 kg drum	LGHC 2/180



Technical data

Designation	LGHC 2		
DIN 51825	KP2N-20	Water resistance DIN 51 807/1, 3 hrs at 90 °C	1 max.
NLGI consistency class	2	Corrosion protection Emcor: – standard ISO 11007 – salt water test (0.5% NaCl)	0–0 0–1
Soap type	Calcium sulphonate complex	Oil separation DIN 51 817, 7 days at 60 °C, static, %	1-3
Colour	Brown/beige	Lubrication ability R2F, running test B at 120 °C	Pass at 140 °C
Base oil type	Mineral	Copper corrosion DIN 51 811, 100 °C	2 max.
Operating temperature range	–20 to +140 °C (–4 to +284 °F)	Rolling bearing grease life R0F test, L ₅₀ life at 10 000 r/min., hrs	1 000 at 110 °C (230 °F)
Dropping point, DIN ISO 2176	>300 °C (>572 °F)	EP performances Wear scar, DIN 51350/5, 1 400 N, mm Weld load, DIN 51350/4, N	1.4 4 000
Base oil viscosity		Shelf life	5 years
40 °C, mm ² /s	450		
100 °C, mm ² /s	31		
Penetration DIN ISO 2137			
60 strokes, 10 ⁻¹ mm	265-295		
100 000 strokes, 10 ⁻¹ mm	+30 max.		
Mechanical stability			
Roll stability, 50 hrs at 80 °C, 10 ⁻¹ mm	+30 max.		

These characteristics represent typical values.

LGHP 2

High performance, high temperature bearing grease



SKF LGHP 2 is a premium quality mineral oil based grease, using a modern Polyurea (di-urea) thickener. It is suitable for electric motors and similar applications.

- Extremely long life at high temperatures
- Wide temperature range
- Excellent corrosion protection
- High thermal and mechanical stability
- Good start-up performance at low temperatures
- Compatibility with common polyurea and lithium thickened greases
- Low noise properties

Typical applications

- Electric motors: Small, medium and large
- Industrial fans, including high speed fans
- Water pumps
- Rolling bearings in textile, paper processing and drying machines
- Applications with medium and high speed ball (and roller) bearings operating at medium and high temperatures
- Clutch release bearings, Vertical shaft applications, Kiln trucks and rollers

Available pack sizes

Pack size	Designation
420 ml cartridge	LGHP 2/0.4
1 kg can	LGHP 2/1
5 kg can	LGHP 2/5
18 kg pail	LGHP 2/18
50 kg drum	LGHP 2/50
170 kg drum	LGHP 2/170



Technical data

Designation	LGHP 2	
DIN 51825 code	K2N-40	Corrosion protection
NLGI consistency class	2-3	Emcor: – standard ISO 11007 0-0
Thickener	Di-urea	– water washout test 0-0
Colour	Blue	– salt water test (0.5% NaCl) 0-0
Base oil type	Mineral	Water resistance
Operating temperature range	-40 to +150 °C (-40 to +300 °F)	DIN 51 807/1, 3 hrs at 90 °C 1 max.
Dropping point DIN ISO 2176	>240 °C (>465 °F)	Oil separation
Base oil viscosity		DIN 51 817, 7 days at 40 °C, static, % 3 max.
40 °C, mm ² /s	96	Lubrication ability
100 °C, mm ² /s	10.5	R2F, running test B at 100 °C Pass
Penetration DIN ISO 2137		Copper corrosion
60 strokes, 10 ⁻¹ mm	245-275	DIN 51 811 1 max. at 150 °C (300 °F)
100 000 strokes, 10 ⁻¹ mm	365 max.	Rolling bearing grease life
Mechanical stability		R0F test, L ₅₀ life at 10 000 r/min., hrs 1 000 min. at 150 °C (300 °F)
Roll stability, 50 hrs at 80 °C, 10 ⁻¹ mm	365 max.	Shelf life
		5 years

These characteristics represent typical values.

Lubricants

LGHQ 2

Electric motor bearing grease



SKF LGHQ 2 is a mineral oil based grease using a di-urea thickener. It is suitable for electric motors and similar applications. It is specifically designed for usage with single point lubricators.

- Excellent dispensability in lubricators
- Extremely long grease life
- Wide temperature range
- High thermal and mechanical stability
- Excellent corrosion protection

Typical applications

- Electric motors: Small, medium and large
- Industrial fans, including high speed fans
- Water pumps
- Rolling bearings in textile, paper processing and drying machines
- Vertical shaft applications

Available pack sizes

Pack size	Designation
420 ml cartridge	LGHQ 2/0.4
1 kg can	LGHQ 2/1
5 kg can	LGHQ 2/5
18 kg pail	LGHQ 2/18
LAGD, TLSD, TLMR	page 177, 179, 187



Technical data			
Designation	LGHQ 2		
DIN 51825 code	K2P-30	Corrosion protection	
NLGI consistency class	2	Emcor: – standard ISO 11007	0–0
Thickener	Di-urea	– water washout test	0–1
Colour	Blue	– 0.5% NaCl	2–2
Base oil type	Mineral	Water resistance	
Operating temperature range	–30 to +160 °C (–2 to +320 °F)	DIN 51 807/1, 3 hrs at 90 °C	1 max.
Dropping point DIN ISO 2176	>260 °C (>500 °F)	Oil separation	
Base oil viscosity		DIN 51 817, 7 days at 40 °C, static, %	1–3
40 °C, mm ² /s	110	Copper corrosion	
100 °C, mm ² /s	12	DIN 51 811	2 max. at 100 °C
Penetration DIN ISO 2137		Rolling bearing grease life	
60 strokes, 10 ⁻¹ mm	265–295	R0F test, L ₅₀ life at 10 000 r/min., hrs	1 000 min. at 160 °C (302 °F)
100 000 strokes, 10 ⁻¹ mm	385 max.	EP performance	
Mechanical stability		Wear scar DIN 51350/5, 1 400 N, mm	1 max.
Roll stability, 50 hrs at 80 °C, 10 ⁻¹ mm	385 max.	4-ball test, welding load DIN 51350/4, N	2600 min.
		Shelf life	5 years

These characteristics represent typical values.

LGET 2

Extreme temperature, extreme condition bearing grease



SKF LGET 2 is a synthetic fluorinated oil based grease, using a PTFE thickener. It is especially suitable for applications at extremely high temperatures from 200 °C (390 °F) up to 260 °C (500 °F).

- Long life in aggressive environments such as very reactive areas with a presence of high purity gaseous oxygen and hexane
- Excellent oxidation resistance
- Good corrosion resistance
- Excellent water and steam resistance

Typical applications

- Kiln truck wheels
- Load rollers in copying machines
- Textile dryers
- Film stretching tenders
- Electric motors running at extreme temperatures
- Emergency / hot fans
- Vacuum pumps

Important note:

LGET 2 is a fluorinated grease and is not compatible with other greases, oils and preservatives (except LGED 2). Therefore, very thorough cleaning of bearings and systems is essential before applying fresh grease.

Note: the density of LGET 2 is about 1.9 g.cm³. This value is twice as high as the average density of a typical bearing grease.

Available pack sizes

Pack size	Designation
50 g (25 ml) syringe	LGET 2/0.050
1 kg can	LGET 2/1



Technical data

Designation	LGET 2		
DIN 51825 code	KFK2U-40	Corrosion protection	
NLGI consistency class	2	Emcor: – standard ISO 11007	1–1 max.
Thickener	PTFE	Water resistance	
Colour	White	DIN 51 807/1, 3 hrs at 90 °C	0 max.
Base oil type	PFPE	Oil separation	
Operating temperature range	–40 to +260 °C (–40 to +500 °F)	DIN 51 817, 7 days at 40 °C, static, %	1-3
Dropping point DIN ISO 2176	>300 °C (>570 °F)	Copper corrosion	
Base oil viscosity		DIN 51 811	1 max. at 150 °C (300 °F)
40 °C, mm ² /s	400	Rolling bearing grease life	
100 °C, mm ² /s	38	ROF test, L ₅₀ life at 10 000 r/min., hrs	>1 000 at 220 °C (428 °F)
Penetration DIN ISO 2137		EP performance	
60 strokes, 10 ⁻¹ mm	265–295	4–ball test, welding load DIN 51350/4, N	8 000 min.
Mechanical stability		Shelf life	5 years
Roll stability, 50 hrs at 80 °C, 10 ⁻¹ mm	±30 max. 130 °C (265 °F)		

These characteristics represent typical values.

Food grade lubricants

Grease	Description	Application examples	Base oil	Temperature range ¹⁾	
				LTTL	HTPL
LGFG 2	General purpose food grade grease	Conveyor bearings Wrapping machines Bottling machines	White mineral oil	-30 °C (-22 °F)	+140 °C (+284 °F)
LGFQ 2	High load, water resistant and wide temperature food grade grease	Pellet presses Mills Mixers	PAO/White mineral oil	-40 °C (-40 °F)	+130 °C (+265 °F)
LGED 2	High temperature & harsh environment bearing grease	Bakery/brick oven equipment Glass industry Vacuum pumps	PFPE	-30 °C (-22 °F)	+240 °C (+464 °F)
LFFM 100	Food grade chain oil	General chain lubrication as in confectionery industries and fruit and vegetable processing. Even in the presence of moisture.	PAO	-30 °C (-22 °F)	+130 °C (+265 °F)
LFFT 220	Food grade chain oil	High temperature applications as bakery ovens	Ester	0 °C (32 °F)	+250 °C (482 °F)
LDS 1	Food grade dry film lubricant	Conveyors in bottling lines using PET, carton, glass or can packages	Mineral/PTFE	-5 °C (25 °F)	+60 °C (140 °F)

These characteristics represent typical values.

Lubricants for non rolling bearing applications

Grease	Description	Application examples	Thickener/Base oil	Temperature range ¹⁾	
				LTTL	HTPL
LMCG 1	Grid and gear coupling grease	Grid and gear couplings Flexible heavy duty grid and gear coupling	Polyethylene / mineral	0 °C (32 °F)	120 °C (248 °F)
LGTE 2	Biodegradable grease for total loss applications	Marine and wire rope applications Construction as well as forestry and agricultural equipment. Ecolabel certified.	Anhydrous calcium / ester	-40 °C (-40 °F)	+100 °C (+212 °F)
LGCC 2	General purpose lubrication systems grease	Plain bearings and sliding guides in off-road and construction machinery	Anhydrous calcium / mineral	-50 °C (-58 °F)	+100 °C (+212 °F)
LGLS 0	Wide temperature lubrication systems grease	Plain bearings and chassis sliding surfaces Centralized lubrication systems	Anhydrous calcium / mineral	-40 °C (-40 °F)	+100 °C (+212 °F)
LGLS 2	High viscosity lubrication systems grease	Slow plain bearings, joints, wire ropes Lubrication systems under medium to high ambient temperatures	Anhydrous calcium / mineral	-20 °C (-4 °F)	+120 °C (+248 °F)
LHMT 68	Medium temperature chain oil	Ideal for medium temperatures and dusty environments	Mineral	-20 °C (-4 °F)	+100 °C (212 °F)
LHHT 250	High temperature chain oil	Ideal for high load and/or high temperature conditions	Ester	-0 °C (32 °F)	+250 °C (482 °F)

These characteristics represent typical values.

¹⁾ LTTL = Low Temperature Torque Limit
HTPL = High Temperature Performance Limit

LGFG 2

General purpose food grade grease



SKF LGFG 2 is a high performance food grade grease using complex calcium sulphonate thickener technology and a white mineral oil. It is suitable for applications subjected to high loads, wet environment and fluctuating temperatures encountered in the among others food and beverage industry.

- Wide temperature range
- Outstanding water resistance and corrosion protection
- Excellent mechanical stability
- Great dispensability in single point automatic lubricators
- Excellent protection against high loads and wear
- NSF ISO 21469 registered as well as Halal and Kosher certified

Typical applications

- Conveyor bearings
- Wrapping machines
- Bottling machines

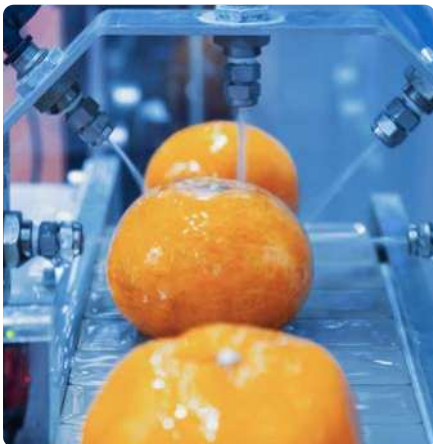

Available pack sizes

Pack size	Designation
420 ml cartridge	LGFG 2/0.4
1 kg can	LGFG 2/1
18 kg pail	LGFG 2/18
180 kg drum	LGFG 2/180
LAGD, TLSD, TLMR	page 177, 179, 187



Technical data

Designation	LGFG 2	
DIN 51825	KP2N-30	Corrosion protection
Thickener	Calcium sulphonate complex	Emcor: – standard ISO 11007 0–0
NLGI grade	2	– salt water test (0.5% NaCl) 0–0
Colour	Brown	– water wash out 0-0
Base oil type	White mineral	Water resistance
Operating temperature range	–30 to +140 °C (–22 to +285 °F)	DIN 51807/1, 3 hrs at 90 °C 1 max.
Dropping point, DIN ISO 2176	>280 °C (>536 °F)	Oil separation
Base oil viscosity		DIN 51817, 7 days at 40 °C, % 1 - 5
40 °C, mm ² /s	150	Lubrication ability
100 °C, mm ² /s	16	R2F, running test B at 120 °C Pass
Penetration DIN ISO 2137		Copper corrosion
60 strokes	265–295	DIN 51811 at 100 °C (210 °F) 1 max.
100 000 strokes	+50 max.	Rolling bearing grease life
Mechanical stability		R0F test, L ₅₀ life at 10 000 r/min., hrs 1 000 min. at 120 °C (248 °F)
Roll stability, 50h at 80 °C, 10 ⁻¹ mm	+50 max.	EP performances
		DIN 51350/5, wear scar, 1 400 N, mm 1 max.
		DIN 51350/4, weld load, N >4 000
		Shelf life 2 years
		NSF Reg. No. 164513

These characteristics represent typical values.

Food grade lubricants

LGFAQ 2

High load, water resistant and wide temperature food grade grease



SKF LGFAQ 2 is a synthetic oil based grease using calcium sulphonate complex thickener. It is suitable for applications subjected to high loads, wet environment and fluctuating temperatures encountered in the food and beverage industry.

- Excellent corrosion protection
- Excellent mechanical stability
- Excellent high load lubricating capacity
- Good false brinelling protection
- Good pumpability down to low temperatures
- NSF ISO 21469 registered and Halal and Kosher certified



Typical applications

- Pellet presses (pet food, sugar, salt)
- Mixers
- Mills
- Centralized lubrication systems

Available pack sizes

Pack size	Designation
420 ml cartridge	LGFAQ 2/0.4
18 kg pail	LGFAQ 2/18
180 kg drum	LGFAQ 2/180
LAGD, TLSD	page 177, 179



Technical data

Designation	LGFAQ 2		
DIN 51825	KP1/2K-40	Water resistance DIN 51807/1, 3 hrs at 90 °C	1 max.
Thickener	Calcium sulphonate complex	Oil separation DIN 51817, 7 days at 40 °C, %	1-3
NLGI grade	1-2	Lubrication ability R2F, running test B at 120 °C	Pass
Colour	Pale brown	Copper corrosion DIN 51811 / ASTM D4048, 24 hrs at 100 °C (210 °F)	2 max.
Base oil type	Synthetic (PAO) / White mineral	Rolling bearing grease life R0F test, L ₅₀ life at 10 000 r/min., hrs	1 000 min. at 120 °C (248 °F)
Operating temperature range	-40 to +130 °C (-40 to +265 °F)	EP performances DIN 51350/5, wear scar, 1 400 N, mm DIN 51350/4, weld load, N	1.5 max. >3 400
Dropping point, DIN ISO 2176	>300 °C (>570 °F)	Shelf life	2 years
Base oil viscosity 40 °C, mm ² /s 100 °C, mm ² /s	320 30	NSF Reg. No.	153759
Penetration DIN ISO 2137 60 strokes 100 000 strokes	280-310 +30 max.	<i>These characteristics represent typical values.</i>	
Mechanical stability Roll stability, 50h at 80 °C, 10 ⁻¹ mm	+30 max.		
Corrosion protection Emcor: - standard ISO 11007 - salt water test (0.5% NaCl)	0-0 0-0		

LGED 2

High temperature and harsh environment food grade grease



Important note:

LGED 2 is a fluorinated grease and is not compatible with other greases, oils and preservatives (except LGET 2). Therefore, very thorough cleaning of bearings and systems is essential before applying fresh grease.

Note:

The density of LGED 2 is about 1.9 cm³. This value is twice as high as the average density of a typical bearing grease.

SKF LGED 2 is a food grade NSF H1 certified grease based on a synthetic fluorinated oil using a PTFE thickener. It is suitable for extremely high temperature from 180 °C (392 °F) up to 240 °C (464 °F) and/or aggressive environments such as acids/alkalis, vacuum, oxygen etc.

- Excellent oxidation resistance
- Very low evaporation losses at high temperature
- Good corrosion resistance
- Long life in aggressive environments such as very reactive areas with a presence of high purity gaseous oxygen and hexane
- NSF H1 registered

Typical applications

- Bakery/brick oven equipment
- Glass industry
- Kiln truck wheels
- Load rollers in copying machines
- Wafer baking equipment
- Textile dryers
- Film stretching tenders
- High temperature fans
- Vacuum pumps

Available pack sizes

Pack size	Designation
1 kg can	LGED 2/1



Technical data

Designation	LGED 2		
DIN 51825 code	KFK2U-30	EP performance 4-ball test, welding load DIN 51350/4, N	8 000 min.
NLGI consistency class	2	Water resistance DIN 51 807/1, 3 hrs at 90 °C	1 max.
Thickener	PTFE	Oil separation DIN 51 817, 7 days at 40 °C, %	1-3
Colour	White	Copper corrosion ISO 2160	1 max. at 100 °C (210 °F)
Base oil type	PFPE	Rolling bearing grease life ROF test, L ₅₀ life at 10 000 r/min., hrs	1000 at 200 °C (392 °F)
Operating temperature range	-30 to +240 °C (-22 to +464 °F)	Evaporation losses 6 weeks at 200 °C, % weight losses	<3.5%
Dropping point DIN ISO 2176	>300 °C (>570 °F)	Oxygen pressure surge ISO 21010	70 bar
Base oil viscosity 40 °C, mm ² /s	460	Shelf life	2 years
100 °C, mm ² /s	42	NSF Reg. No.	156010
Penetration DIN ISO 2137 60 strokes, 10 ⁻¹ mm	265-295		
100 000 strokes, 10 ⁻¹ mm	+30		
Corrosion protection Emcor: - standard ISO 11007	0-0		

These characteristics represent typical values.

Food grade lubricants

LFFM 100

LFFT 220

Food grade chain oil

The SKF food grade chain oils are specifically designed and certified for use in chain applications in food processing and pharmaceutical industries

LFFM 100 - General purpose food grade chain oil

SKF LFFM 100 is a high-performance synthetic chain oil specially formulated for the lubrication of chains operating in food processing and pharmaceutical industries. It provides excellent load and anti-wear properties even in the presence of moisture and in low temperature environments.

- Certified for food industry with: NSF H1, NSF ISO 21469, Halal and Kosher
- Especially suitable for moist and low temperature environments
- Excellent steel and copper corrosion inhibition properties
- Excellent anti-wear protection
- Excellent oxidation stability
- Low residue formation

LFFT 220 - High temperature food grade chain oil

SKF LFFT 220 is a high performance synthetic oil specially formulated for the lubrication of chains operating at high temperatures and high loads in food processing and pharmaceutical industries. It provides excellent load and anti-wear properties and forms virtually no lacquers or residues, even when working at high temperatures.

- Certified for food industry with: NSF H1, NSF ISO 21469, Halal and Kosher
- Especially suitable for high operating temperatures, long relubrication intervals and low friction coefficients
- Excellent anti-wear protection
- Excellent steel and copper corrosion inhibition properties
- Excellent oxidation stability
- Virtually residue-free



Available pack sizes

Pack sizes	LFFM 100	LFFT 220
5 litre can	LFFM 100/5	LFFT 220/5
LAGD, TLSD	page 177, 179	page 177, 179

Technical data

Designation	LFFM 100	LFFT 220
Colour	Colourless	Yellow reddish
Base oil type	PAO	Ester
Density, DIN 51757, at 20°C (68 °F)	0.84 g/cm ³ (0.03 lb/in ³)	1.1 g/cm ³ (0.03 lb/in ³)
Operating temperature range	-30 to +130 °C (-22 to +265 °F)	Up to 250 °C (482 °F)
Flash point, DIN ISO 2592	>200 °C (>392 °F)	>250 °C (482 °F)
Pour point, DIN ISO 3016	≤-50 °C (-58 °F)	≤-30 °C (-22 °F)
Base oil viscosity ISO 3104:		
40 °C (104 °F), mm ² /s	ISO VG 100	ISO VG 220
100 °C (212 °F), mm ² /s	approx. 15	approx. 25
Water and corrosion		
Steel corrosion DIN ISO 7120-B	Pass	Pass
Copper corrosion DIN 51811 (3h/100 °C (212 °F))	1 max	1 max
NSF Registration number	162872	162871
Shelf life	2 years	2 years

These characteristics represent typical values.

LDTS 1

Food grade dry film lubricant



Dry film lubricant LDTS 1 has been specially developed for automatic lubrication of plastic flat top chain conveyors in the beverage processing industry. The lubricant consists of mineral oil and is doped with PTFE solid lubricant.

After storage a separation of the ingredients could be observed in the container, this is normal. Shaking the product will bring it to a normal status. Automatic lubrication systems must have an stirring mechanism.

- Cost savings by eliminating high volume of water and soluble lubricant
- Improved operator safety by reducing slip hazards
- Quality of packaging is maintained by elimination of moisture
- Reduced risk of product contamination by minimising microbiological growth
- Enhanced line efficiency by avoiding replacement costs and associated unplanned production stops
- Reduced cleaning costs
- NSF H1 registered

Typical applications

- Conveyors in bottling lines using PET, carton, glass or can packages.



Available pack sizes

Pack sizes	Designation
5 l can	LDTS 1/5



Technical data

Designation	LDTS 1		
Composition	Mineral oils, hydrocarbons, additives, PTFE	Density 25 °C (77 °F)	ca. 841 kg/m ³
Appearance	White	Flash point of the preparation	ca. 100 °C (210 °F)
Operating temperature range	-5 to +60 °C (25 to 140 °F)	Flash point after evaporation of the solvent	>170 °C (340 °F)
Viscosity at 40 °C (104 °F)	ca. 28 mm ² /s	NSF Reg. No.	139739
Pour point	<0 °C	Shelf life	2 years

These characteristics represent typical values.

Lubricants for non rolling bearing applications

LMCG 1

Grid and gear coupling grease



LMCG 1 is a polyethylene thickened and mineral oil based grease which also uses a lithium complex thickening technology. The grease is formulated to withstand high centrifugal forces and high-torque applications for grid and gear (flexible) couplings even where severe shock loadings, misalignment and vibration occur.

Leakage is prevented at high speeds and the grease is stable in consistency. The special additive formulations make the grease suitable for applications subjected to high loads, high torque, wet environments, a wide range of speed regimes and wide range of temperatures.

- Excellent resistance to oil separation
- High acceleration and high operating speeds
- Excellent high-torque lubrication
- High corrosion protection
- Exceeds AGMA Type CG-1 and AGMA Type CG-2 requirements

Typical industries

- Heavy industries (mining, mineral processing, cement, steel, pulp & paper).
- Marine industry.
- General machinery (petrochemical, power generation plants, etc.).



Applications

- Grid and gear couplings
- Flexible heavy duty grid and gear coupling

Available pack sizes

Pack size	LMCG 1
420 ml cartridge	LMCG 1/0.4
2 kg can	LMCG 1/2
18 kg pail	LMCG 1/18



Technical data

Designation	LMCG 1		
DIN 51825 code	AGMA CG- 2	Corrosion protection, Emscor	ISO 11007, Distilled water
NLGI consistency class	1	Water resistance (max.)	0-0
Thickener	Polyethylene	Water wash-out test, ISO 11009	<10% at 38 °C
Colour	Brown	Copper corrosion (max.)	
Base oil type	Mineral	DIN 51811 / ASTM D4048, 24 hrs at 100 °C	1b max.
Operating temperature range	0 to 120 °C (32 to 248 °F)	EP performance	
Dropping point (min), ISO 2176	160 °C (320 °F)	4 ball - Wear scar (max.) DIN 51 350,	
Base oil viscosity, DIN 51562		1 400 N, mm	ASTM D2266 - 0.5 mm
40 °C, mm ² /s	761	4 ball - Weld load (min.) DIN 51350/4, N	ASTM D2539 - 315 kgf
100 °C, mm ² /s	44	Other data	
Penetration DIN ISO 2137		Koppers Method ASTM D4425. K36, 24h	<24%
Worked, 60 strokes, 10 ⁻¹ mm	310-340	Flow pressure, DIN 51805-2	<1 400 mbar at -10°C
Prolonged (max.), 100 000 strokes, 10 ⁻¹ mm	+50 max.	Density (DIN 51757) at 20 °C (68 °F)	0.94
Prolonged (max.), 10 000 strokes, 10 ⁻¹ mm	+25 max.	Shelf life	5 years

These characteristics represent typical values.

LGTE 2

Biodegradable grease for total loss applications



LGTE 2 is grease for total loss applications based on biodegradable esters and anhydrous calcium thickener. The grease is environmentally acceptable and certified with Ecolabel, making it the ideal grease for marine applications such as wire ropes.

- Biodegradable and categorized as “Total loss lubricant (TLL)” as defined by Ecolabel
- Environmentally acceptable lubricant according to “2013 Vessel General Permit”
- Excellent pumpability at low to medium temperatures
- Excellent adhesion to surfaces
- Excellent water resistance
- High load capacity

Typical applications

- Wire ropes
- Marine
- Construction equipment
- Forestry and agricultural equipment
- Heavy duty off-road application
- Plain bearings and bushings



Available pack sizes

Pack size	Designation
18 kg pail	LGTE 2/18

Technical data

Designation	LGTE 2		
DIN 51825 code	KPE2G-40	Water resistance (max.)	
NLGI consistency class	2	DIN 51 807/1, 3 hrs at 90 °C	1 max.
Thickener	Anhydrous calcium	Water wash-out test, ISO 11009	<5%
Colour	Yellow	Copper corrosion (max.)	
Base oil type	Ester	DIN 51811 / ASTM D4048, 24 hrs at 100 °C	2 max.
Operating temperature range	-40 to 100 °C (-40 to 212 °F)	EP performance	
Dropping point (min), ISO 2176	>140 °C (>284 °F)	4 ball - Wear scar (max.) DIN 51 350, 1 400 N, mm	2 max.
Base oil viscosity, DIN 51562		4 ball - Weld load (min.) DIN 51350/4, N	3 200 min.
40 °C, mm ² /s	500	Other data	
100 °C, mm ² /s	50	Flow pressure, DIN 51805-2	<1 400@ -40 °C
Penetration DIN ISO 2137		Density (DIN 51757) at 20 °C (68 °F)	0.95
Worked, 60 strokes, 10 ⁻¹ mm	265 - 295	Shelf life	2 years
Prolonged (max.), 100 000 strokes, 10 ⁻¹ mm	+35 max.	Certifications	ECOLABEL SE/027/008
Corrosion protection, Emscor			
ISO 11007, Distilled water	0 - 0		
ISO 11007 modified, Water washout	0 - 0		
ISO 11007 modified, 0.5% NaCl	<2 - 2		

These characteristics represent typical values.

Lubricants for non rolling bearing applications

LGCC 2

General purpose lubrication systems grease

SKF LGCC 2 is a general purpose grease specially engineered to deliver superior performance in a wide range of lubrication systems, particularly excelling in environments with very low temperatures. Its advanced formulation ensures exceptional water resistance and robust corrosion protection, making it ideal for demanding non-rolling bearing applications.

- Outstanding low-temperature performance
- Excellent water resistance
- Enhanced corrosion protection

Typical applications

- Lubrication systems exposed to low to medium temperatures
- Construction machinery
- Forestry and agricultural equipment
- Collector trucks
- Chassis applications
- Hinges, Joints, articulations and linkages
- Slow rotating sliding bearings and bushings



Available pack sizes

Pack size	Designation
420 ml cartridge	LGCC 2/0.4
18 kg pail	LGCC 2/18
180 kg drum	LGCC 2/180



Technical data

Designation	LGCC 2	
DIN 51825 code	K1/2 G-50	Corrosion protection, Emscor ISO 11007, Distilled water 0-0
NLGI consistency class	1-2	Water resistance (max.) DIN 51 807/1, 3 hrs at 90 °C 1 max.
Thickener	Anhydrous calcium	Copper corrosion (max.) DIN 51811 / ASTM D4048, 24 hrs at 100 °C 1 max.
Colour	Light brown	EP performance 4 ball - Weld load (min.) DIN 51350/4, N 2 000 min
Base oil type	Mineral	Other data Flow pressure, DIN 51805-2 <1 400 at -50 °C (-58 °F)
Operating temperature range	-50 to +100 °C (-58 to +212 °F)	Pumpability (P203), SKF FTG 6, °C/°F Pumpable at -35
Dropping point (min), ISO 2176	>135 °C (275 °F)	Density (DIN 51757) at 20 °C (68 °F) 0.87
Base oil viscosity, DIN 51562		Shelf life 5 years
40 °C, mm ² /s	110	
100 °C, mm ² /s	9	
Penetration DIN ISO 2137		
Worked, 60 strokes, 10 ⁻¹ mm	300-325	
Prolonged (max.), 100 000 strokes, 10 ⁻¹ mm	+70 max.	

These characteristics represent typical values.

LGLS 0

Wide temperature lubrication systems grease



SKF LGLS 0 is a semi-fluid chassis grease that has been developed to be used via lubrication systems under low to medium temperatures. Its anhydrous calcium thickener, combined with a high base oil viscosity, offers excellent water resistance and stickiness to surfaces as well as very good anti-wear properties.

- Excellent pumpability at low to medium temperatures
- Excellent water resistance and corrosion protection
- Excellent anti-wear properties
- Excellent adhesion to surfaces

Typical applications

- Construction equipment
- Heavy duty off-road applications such as excavators, wheel loaders, etc
- Forestry and agricultural equipment such as forwarders and harvesters
- Collector trucks
- Joints
- Slow plain and rolling bearings

Available pack sizes

Pack size	Designation
18 kg pail	LGLS 0/18
50 kg drum	LGLS 0/50
180 kg drum	LGLS 0/180



Technical data

Designation	LGLS 0		
DIN 51825 code	KPOG-40	Water resistance (max.)	
NLGI consistency class	0	DIN 51 807/1, 3 hrs at 90 °C	0
Thickener	Anhydrous calcium	Water wash-out test, ISO 11009	<10%
Colour	Red	EP performance	
Base oil type	Mineral oil & polymers	4 ball - Wear scar (max.) DIN 51 350, 1 400 N, mm	2 max.
Operating temperature range	-40 to +100 °C (-40 to +212 °F)	4 ball - Weld load (min.) DIN 51350/4, N	2 600 N
Dropping point (min), ISO 2176	> 120	Other data	
Base oil viscosity, DIN 51562		Koppers Method ASTM D4425, K36, 24h	
40 °C, mm ² /s	1 370	Flow pressure, DIN 51805-2	<1 400 at -40 °C
100 °C, mm ² /s	96	Density (DIN 51757) at 20 °C (68 °F)	0.89
Penetration DIN ISO 2137		Shelf life	5 years
Worked, 60 strokes, 10 ⁻¹ mm	355-385		
Prolonged (max.), 100 000 strokes, 10 ⁻¹ mm	+50 max.		
Corrosion protection, Emcor			
ISO 11007, Distilled water	0-0		

These characteristics represent typical values.

Lubricants for non rolling bearing applications

LGLS 2

High viscosity lubrication systems grease



SKF LGLS 2 is a high viscosity grease that has been developed to be used ideally via lubrication systems under medium to high ambient temperatures. Its anhydrous calcium thickener, combined with a high base oil viscosity, offers excellent water resistance and stickiness to surfaces as well as very good anti-wear properties.

- Excellent pumpability at medium to high ambient temperatures
- Excellent water resistance and corrosion protection
- Excellent anti-wear properties
- Excellent adhesion to surfaces

Typical applications

- Construction equipment
- Heavy duty off-road applications such as excavators, wheel loaders, etc
- Forestry and agricultural equipment such as forwarders and harvesters
- Collector trucks
- Chassis
- Harbour equipment
- Marine
- Wire rope lubrication
- Joints
- Slow plain bearings

Available pack sizes

Pack size	Designation
420 ml cartridge	LGLS 2/0.4
18 kg pail	LGLS 2/18
50 kg drum	LGLS 2/50
180 kg drum	LGLS 2/180



Technical data

Designation	LGLS 2	
DIN 51825 code	KP2K-20	Corrosion protection, Emcor
NLGI consistency class	2	ISO 11007 modified, Water washout
Thickener	Anhydrous calcium	0-0
Colour	Red	Water resistance (max.)
Base oil type	Mineral oil & polymers	Water wash-out test, ISO 11009
Operating temperature range	-20 to +120 °C (-4 to +248 °F)	5%
Dropping point (min), ISO 2176	>140 °C (>284 °F)	EP performance
Base oil viscosity, DIN 51562		4 ball - Wear scar (max.) DIN 51 350, 1
40 °C, mm ² /s	1 300	400 N, mm
100 °C, mm ² /s	106	4 ball - Weld load (min.) DIN 51350/4, N
Penetration DIN ISO 2137		2 800 N
Worked, 60 strokes, 10 ⁻¹ mm	265-295	Other data
Prolonged (max.), 100 000 strokes, 10 ⁻¹ mm	+35 max.	Flow pressure, DIN 51805-2
		<1 400 mbar @-20°C
		Density (DIN 51757) at 20 °C (68 °F)
		0.89
		Shelf life
		5 years

These characteristics represent typical values.

LHMT 68

LHHT 250



Chain oil

SKF Chain oils are specifically designed for industrial chain applications and can be used in virtually every industry.

Typical applications

- Conveyor chains
- Drive chains
- Lift chains
- Ovens

LHMT 68 - Medium temperature chain oil

SKF LHMT 68 is a high-performance mineral oil specially formulated for the lubrication of chains operating at medium temperatures. It provides excellent anti-wear and anti-corrosion properties.

- Very good anti-wear protection
- Very good steel and copper corrosion inhibition properties
- Free from silicone

LHHT 250 - High temperature chain oil

SKF LHHT 250 is a high-performance synthetic oil specially formulated for the lubrication of chains at high temperatures and high loads. It provides excellent load and anti-wear properties and forms virtually no lacquers or residues, even when operating at high temperatures.

- High temperature and high load
- Excellent anti-wear protection
- Very good steel and copper corrosion inhibition properties
- Excellent oxidation stability
- Free from silicone
- Virtually residue-free

Available pack sizes

Pack sizes	LHMT 68	LHHT 250
5 litre can	LHMT 68/5	LHHT 250/5
LAGD, TLSD	page 177, 179	page 177, 179



Technical data

Designation	LHMT 68	LHHT 250
Colour	Yellow brown	Amber
Base oil type	Mineral	Ester
Density, DIN 51757, at 20°C (68 °F)	0.88 g/cm ³ (0.03 lb/in ³)	0.94 g/cm ³ (0.03 lb/in ³)
Operating temperature range	-20 to +100 °C (-4 to +212 °F)	Up to 250 °C (482 °F)
Flash point, DIN ISO 2592	>200 °C (392 °F)	>250 °C (482 °F)
Pour point, DIN ISO 3016	<-30 °C (-22 °F)	≤-40 °C (-40 °F)
Base oil viscosity ISO 3104:		
40 °C (104 °F), mm ² /s	ISO VG 68	approx. 250
100 °C (212 °F), mm ² /s	approx. 9	approx. 24
Water and corrosion		
Steel corrosion DIN ISO 7120-A	Pass	Pass
Copper corrosion DIN 51811 (3h/100 °C (212 °F))	1 max	1 max
Shelf life	5 years	5 years

These characteristics represent typical values.

Automatic grease dispensing tools

Manual lubrication vs. automatic lubrication

Performing manual lubrication tasks can be challenging due to the vast number of lubrication points throughout a factory. Also, most of these points have varying lubrication requirements. Utilising automatic lubricators is one solution that can improve worker safety and increase machine reliability.

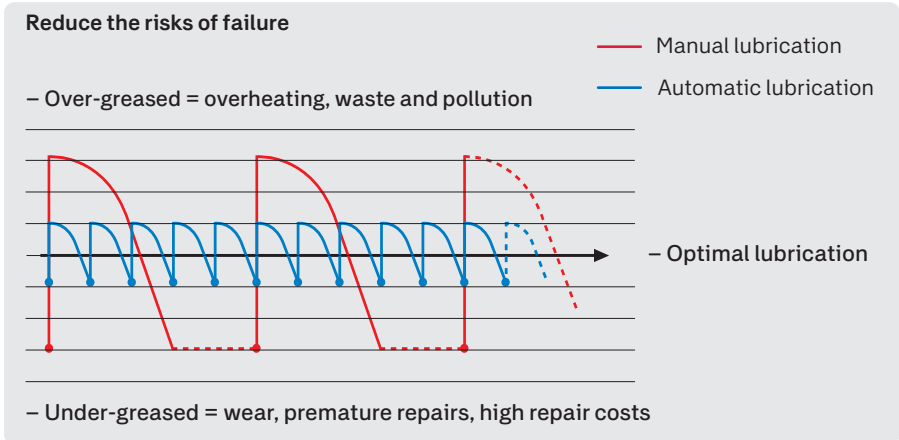

Challenges associated with manual lubrication

Manual lubrication tasks can be complex and inconvenient, often requiring equipment shutdown. Manual lubrication on difficult-to-access lubrication points also can increase the possibility of worker injury and take your valuable human resources away from other tasks.

Improper manual lubrication can be a factor in creating additional challenges. Failure to lubricate every lubrication point regularly can have a negative effect on equipment reliability, production schedules and

maintenance efficiency. Other results of improper manual lubrication can be lubricant waste, environmental issues, increased energy consumption and finished product spoilage due to contamination of lubricant.

Benefits of using automatic lubricators

A lubricator is designed to automatically supply a small quantity of clean grease or oil to a lubrication point on a regular basis, thus improving bearing performance. Key benefits of using an automatic lubricator are improved employee safety, increased

machine reliability and optimized maintenance operations.

SKF SYSTEM 24 lubricators are suitable for a variety of applications but often are used on pumps, electric motors, fans, blowers, conveyors and chains. They can be adjusted to ensure that the correct quantity of lubricant is delivered to the lubrication point during a predetermined period of time. This provides a more accurate control of the amount of lubricant supplied, when compared to traditional manual lubrication techniques.

Improving employee safety

Use of SKF SYSTEM 24 lubricators can have a positive impact on workplace safety because technicians can spend less time in confined spaces, with safety cages or guards removed, and on rooftop or elevated lubrication tasks.

Lubrication point behind safety guards

Safety cages and guards are utilised for a reason - to protect workers and others from injury caused by moving parts. By reducing the amount of time these implements are not in place, SKF SYSTEM 24 lubricators increase safety and eliminate the need to manually lubricate difficult-to-access lubrication points.

Elevated lubrication point

Lubrication points on rooftops or other high elevations can create a significant challenge, and the safety implications are evident. Due to apprehension, these lubrication points often are not lubricated properly and equipment reliability suffers.

Manual handling of lubricants

Improper handling of loose lubricant can expose technicians to chemicals. By eliminating manual handling of lubricant, SKF SYSTEM 24 lubricators reduce the potential for chemical exposure of workers.

Machine reliability

The importance of lubrication often is overlooked due to its underestimated impact on equipment total cost of ownership. However, machine reliability can be enhanced substantially with proper lubrication. As the leading supplier of bearings worldwide, SKF has conducted extensive research and determined that up to 50 percent of premature bearing failures are due to either improper lubrication practices or contamination.

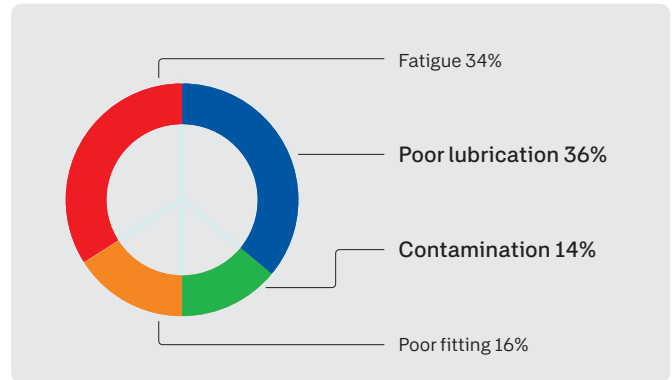

Clean, fresh lubricant

A continuous supply of clean, fresh grease or oil is essential when lubricating equipment. SKF SYSTEM 24 lubricators feature high quality SKF lubricants in a water- and dust-resistant design.

Positive pressure

Positive pressure prevents contaminants from entering the bearing through the seal. SKF SYSTEM 24 lubricators can provide fresh lubricant and purge seals of smaller-

sized bearings operating at lower speeds, while larger bearings may benefit from a separate lubricator for lubrication and seal purging.

Missed lubrication points

With manual lubrication, it is difficult and time consuming to find every lubrication point. Use of SKF SYSTEM 24 lubricators helps to ensure that each point is receiving the proper amount of lubricant on a set schedule.

Premature bearing failure

Approximately 36 percent of premature bearing failures are due to improper lubrication, such as too much, too little or the wrong type of lubricant. Another 14 percent of bearing failures occur because of contamination via poor seals or lubricant handling practices.

Supporting effective maintenance

The use of automatic lubricators can have a large impact on effective maintenance. The most significant benefits usually are found in the reduction of unplanned downtime, machine repair costs, labor and lubricant consumption.

Improved machine reliability

Using an SKF SYSTEM 24 lubricator provides increased machine reliability and, therefore, reduces unplanned downtime.

Increased productivity

Because automatic lubricators deliver lubricant while the equipment is in operation, there is less scheduled downtime and more productivity.

Better use of personnel

Automatic lubrication enables workers to focus on more value-added tasks, such as machine inspection.

Lower cost of ownership

Improved equipment reliability and performance means lower machine repair costs.

Cost savings of automatic lubrication

Based on numerous case studies, the illustration at left represents a comparison of manual vs. automatic lubrication. The results show improvement in all areas when using automatic lubrication with the most significant found in the reduction of downtime and repair costs.

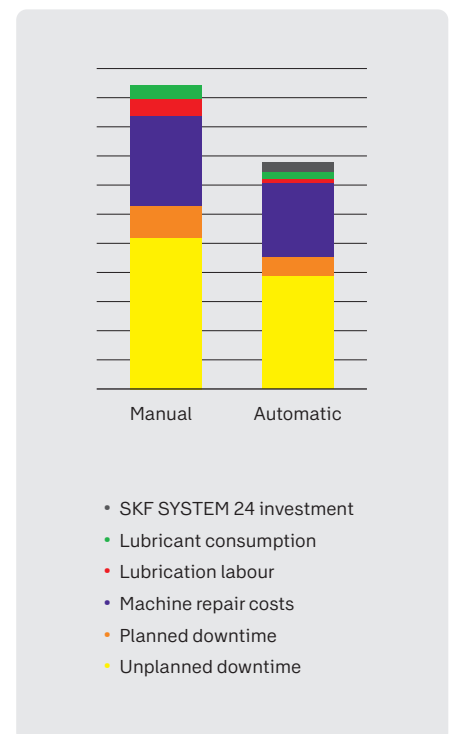

SKF SYSTEM 24

Gas driven single point automatic lubricators

LAGD series

The units are supplied ready-to-use straight from the box and filled with a wide range of high performance SKF lubricants. Tool-free activation and time-setting allow easy and accurate adjustment of lubrication flow.

- Flexible dispense rate from 1 to 12 months
- Stoppable or adjustable if required
- Intrinsic safety rating: ATEX approved for zone 0
- Transparent lubricant container allows visual inspection of dispense rate
- Compact size, permits installation in restrictive areas
- Greases and chain oils available

Typical applications

- Applications in restrictive and hazardous locations
- Bearing housing lubrication
- Electric motors
- Fans and pumps
- Conveyors
- Cranes
- Chains (oil)
- Elevators and escalators (oil)

SKF DialSet (dialset.skf.com) helps to calculate the correct dispense rate.

Multiple accessories are available for LAGD lubricators. More information can be found on pages 190-191.



Easy-grip top-cover

Specially designed top ring for an optimum grip

Gas cell

Detachable batteries for an environmentally friendly disposal

Lubricant container

Transparent lubricant container allows visual inspection of dispense rate

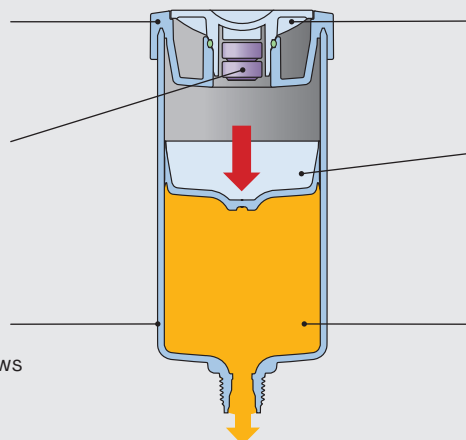

Toolless dial

Allows easy and accurate adjustment of flow rate

Piston

Special piston shape helps ensure optimum emptying of lubricator

SKF Lubricants

Filled with high quality SKF lubricants



Grease	Description	Unit 60 ml	Unit 125 ml
LGWA 2	High load, extreme pressure, wide temperature range	LAGD 60/WA2	LAGD 125/WA2
LGEM 2	High viscosity with solid lubricants	LAGD 60/EM2	LAGD 125/EM2
LGGB 2	Biodegradable	–	LAGD 125/GB2
LGHB 2	High load, high temperature, high viscosity	LAGD 60/HB2	LAGD 125/HB2
LGHQ 2	High load, high temperature, high viscosity	LAGD 60/HQ2	LAGD 125/HQ2
LGWM 2	High loads, wide temperature	–	LAGD 125/WM2
LGFG 2	General purpose food grade (NSF H1)	LAGD 60/FG2	LAGD 125/FG2
LGFQ 2	High load and wide temperature food grade (NSF H1)	–	LAGD 125/FQ2
Chain oils ¹⁾			
LHMT 68	Medium temperature	LAGD 60/HMT68	LAGD 125/HMT68
LHHT 250	High temperature	–	LAGD 125/HT250
LFFM 100	General purpose food grade (NSF H1)	–	LAGD 125/FM100
LFFT 220	High temperature food grade (NSF H1)	–	LAGD 125/FT220
	Empty unit suitable for oil filling only	LAGD 60/U	LAGD 125/U

¹⁾ Includes non-return valve

Technical data			
Designation	LAGD 60 and LAGD 125		
Grease capacity		Intrinsically safe approval	
LAGD 60	60 ml (2 US fl. oz)		II 1G Ex ia IIC T6 Ga
LAGD 125	125 ml (4.2 US fl. oz)		II 1D Ex ia IIIC T ₂₀₀ 85°C Da
			I M1 Ex ia I Ma
Nominal emptying time	Adjustable; 1–12 months	EC Type examination certificate	DEKRA 21ATEX0015 X
Ambient temperature range		Protection class	IP 68
LAGD 60/.. and LAGD 125/..	–20 to +60 °C (–5 to +140 °F)	Recommended storage temperature	20 °C (70 °F)
Maximum operating pressure	5 bar (75 psi) (at start-up)	Storage life of lubricator	2 years
Drive mechanism	Gas cell producing inert gas	Weight	
Connection thread	R ¹ / ₄	LAGD 60	approx 130 g (4.6 oz)
Maximum feed line length with:		LAGD 125	approx 200 g (7.1 oz)
grease	300 mm (11.8 in.)		Lubricant included
oil	1 500 mm (59.1 in.)		

Note: If ambient temperature is constant between 40 °C and 60 °C (105 °F and 140 °F), do not select a setting of more than 6 months for optimum performance.

SKF SYSTEM 24

Electro-mechanical single point automatic lubricators

TLSD series

The SKF TLSD series is the first choice when a simple and reliable automatic lubricator is required under variable temperatures, or when the application conditions (such as vibration, limited space or hazardous environments) require a remote mounting.

- Filled with SKF Lubricants especially developed for bearing applications
- Maximum discharge pressure of 5 bar over the whole dispensing period
- Transparent reservoir allows visual inspection
- Refill sets include battery pack
- Suitable for both direct and remote installation
- Complete sets are supplied ready to use, including the drive unit, battery pack, filled lubricant canister and matching support plate.

Typical applications

- Critical applications where extreme reliability and additional monitoring is required
- Applications in restrictive and hazardous locations
- Applications requiring high volumes of lubricant

SKF DialSet (dialset.skf.com) helps to calculate the correct dispense rate.

Multiple accessories are available for TLSD lubricators. More information can be found on pages 190-191.



- A** The unit can be programmed to dispense lubricant in 1, 2, 3, 4, 6, 8, 9, 10 and 12 month settings.
- B** The same drive unit can be used with both cartridge versions by simply adjusting the 125/250 ml switch.
- C** Traffic light LEDs are visual from all sides because of the presence of dual LEDs on the sides of the lubricator. The meaning of the lights is as follows:
 - Green light: The lubricator is properly functioning.
 - Yellow light: The lubricator is still functioning, but soon some action will be required. Yellow light serves as a pre-warning light.
 - Red light: The lubricator stopped operating.





Ordering details

Grease	Description	Complete unit 125	Complete unit 250	Cartridge set 125	Cartridge set 250
LGWA 2	High load, extreme pressure, wide temperature range	TLSD 125/WA2	TLSD 250/WA2	LGWA 2/SD125	LGWA 2/SD250
LGEM 2	High viscosity bearing grease with solid lubricants	TLSD 125/EM2	TLSD 250/EM2	LGEM 2/SD125	LGEM 2/SD250
LGHB 2	High load, high temperature, high viscosity	TLSD 125/HB2	TLSD 250/HB2	LGHB 2/SD125	LGHB 2/SD250
LGHQ 2	High performance, high temperature	TLSD 125/HQ2	TLSD 250/HQ2	LGHQ 2/SD125	LGHQ 2/SD250
LGFG 2	General purpose food grade (NSF H1)	TLSD 125/FG2	TLSD 250/FG2	LGFG 2/SD125	LGFG 2/SD250
LGFQ 2	High load and wide temperature food grade (NSF H1)	–	–	LGFQ 2/SD125	LGFQ 2/SD250

Chain oils

LHMT 68	Medium temperature oil	TLSD 125/HMT68 ¹⁾	TLSD 250/HMT68 ¹⁾	LHMT 68/SD125 ²⁾	LHMT 68/SD250 ²⁾
LFFM 100	General purpose food grade (NSF H1)	–	–	LFFM 100/SD125 ²⁾	LFFM 100/SD250 ²⁾

¹⁾ Includes support plate with non-return valve.

²⁾ Support plate with non return valve (TLSD 1-SPV) can be ordered separately.

Technical data

Designation	TLSD 125/... and TLSD 250/...	
Grease capacity	TLSD 125	125 ml (4.2 US fl. oz)
	TLSD 250	250 ml (8.5 US fl. oz)
Emptying time	User adjustable: 1, 2, 3, 4, 6, 8, 9, 10 and 12 months	
Lowest grease purge	TLSD 125	0.3 ml (0.01 US fl. oz) per day
	TLSD 250	0.7 ml (0.02 US fl. oz) per day
Highest grease purge	TLSD 125	4.1 ml (0.13 US fl. oz) per day
	TLSD 250	8.3 ml (0.28 US fl. oz) per day
Ambient temperature range	TLSD 1-BAT	0 to 50 °C (30 to 120 °F)
	TLSD 1-BATC (optional)	-10 to 50 °C (14 to 122 °F)
Maximum operating pressure	5 bar (75 psi)	
Drive mechanism	Electro mechanical	
Connection thread	G ¹ / ₄	
Maximum feed line length with:	grease	Up to 3 meters (10 ft) ¹⁾
	oil	Up to 5 meters (16 ft)
LED status indicators	Green led (each 30 sec)	OK
	Yellow led (each 30 sec)	Pre warning, low battery power
	Yellow led (each 5 sec)	Pre warning, high back pressure
	Red led (each 5 sec)	Warning, stopped on error
	Red led (each 2 sec)	Warning, empty cartridge
Protection class assembled lubricator	IP 65	
Battery pack	TLSD 1-BAT	4.5 V 2.7 Ah/Alkaline manganese
	TLSD 1-BATC (optional)	4.5 V. 2.7 Ah/Lithium
Recommended storage temperature	20 °C (70 °F)	
Storage life of lubricator	3 years ²⁾ (2 years for food grade lubricants and oils)	
Total weight (incl. packaging)	TLSD 125	635 g (22.5 oz)
	TLSD 250	800 g (28.2 oz)

¹⁾ The maximum feed line length is dependent on ambient temperature, grease type and back pressure created by the application.

²⁾ Maximum storage life is 3 years from production date, which is printed on the side of the canister. The canister and battery pack may be used at 12 month setting even if activated 3 years from production date.

SKF SYSTEM 24

Cabled single point automatic lubricator

TLSD 1-DK

The Cabled single point automatic lubricator is based on the proven single point automatic lubricator TLSD series. Main differentiators are the direct power supply from the machine's control panel and the wired signal function towards the machine's PLC.

Cabled single point automatic lubricators can be set to help ensure that the correct quantity of lubricant is delivered over a set time period and when the machine is running. Because of being powered from an external power supply, it can be switched on and off when necessary. This allows improved accuracy of the amount of lubricant supplied compared to traditional manual re-lubrication techniques. The lubricator's output signals can be used and stored within the equipment's PLC. The Cabled single point automatic lubricator has been developed for applications which are not running continuously.

- Possibility to lubricate only when the equipment is running
- Control and monitoring through machine PLC connection
- Suitable for both direct and remote installation
- Direct power supply
- Temperature independent dispense rate
- Maximum discharge pressure of 5 bar (75 psi) over the whole dispensing period
- Dispense rate available in various settings
- Red-yellow-green LEDs indicate the lubricator's status
- Reduce the service visits
- Cartridges filled with SKF lubricants especially developed for bearing applications
- Transparent cartridge reservoir allows visual inspection

Typical applications

- Critical applications where extreme reliability and additional monitoring is required
- Industrial equipment
- Elevators
- Compressors

SKF DialSet (dialset.skf.com) helps to calculate the correct dispense rate.

Multiple accessories are available for TLSD lubricators. More information can be found on pages 190-191.

Drive unit - TLSD 1-DK

Top part with electric drive and time setting wheel. Supplied with cable, plastic cap and support plate for grease lubrication (TLSD 1-SP).

Cartridge - e.g. LGWA 2/SD125NB

Replaceable cartridge filled with 125 ml or 250 ml of SKF grease or oil. Cartridges are to be ordered separately.

Support plate

TLSD 1-SP is the support plate for grease lubrication.

TLSD 1-SPV is the support plate with integrated non-return valve for oil lubrication and can be ordered separately.





Ordering details - Cartridges (excl. a battery)

Grease	Description	Cartridge 125	Cartridge 250
LGWA 2	High load, extreme pressure, wide temperature range	LGWA 2/SD125NB	LGWA 2/SD250NB
LGEM 2	High viscosity bearing grease with solid lubricants	LGEM 2/SD125NB	LGEM 2/SD250NB
LGHB 2	High load, high temperature, high viscosity	LGHB 2/SD125NB	LGHB 2/SD250NB
LGHQ 2	High performance, high temperature	LGHQ 2/SD125NB	LGHQ 2/SD250NB
LGFG 2	General purpose food grade (NSF H1)	LGFG 2/SD125NB	LGFG 2/SD250NB
LGFQ 2	High load and wide temperature food grade (NSF H1)	LGFQ 2/SD125NB	LGFQ 2/SD250NB

Ordering details - Components

Designation	Description
TLSD 1-DK	Cabled drive-unit
TLSD 1-SP	Support plate (supplied with TLSD 1-DK)
TLSD 1-SPV	Support plate with integrated non-return valve
.../SD125NB	Cartridge filled with SKF bearing grease or chain oil (see table to the left)
.../SD250NB	

Chain oils

LHMT 68	Medium temperature oil	-	LHMT 68/SD250NB ¹⁾
----------------	------------------------	---	-------------------------------

¹⁾ Support plate with non return valve (TLSD 1-SPV) can be ordered separately.



Technical data

Product Cabled automatic lubricator TLSD series

Grease capacity	125 ml (4.2 US fl. oz)	LED status indicators	OK
.../SD125	250 ml (8.5 US fl. oz)	Green led (each 3 sec)	Warning, high back pressure
.../SD250		Yellow led (each 1 sec)	Warning, cartridge almost empty (3% left)
Emptying time	User adjustable: 1, 2, 3, 4, 6, 8, 9, 10 and 12 months	Yellow led (each 3 sec)	Alarm, high back pressure
Lowest grease purge		Red led (each 1 sec)	Alarm, empty cartridge
.../SD125	0.3 ml (0.01 US fl. oz) per day	Red led (each 3 sec)	Alarm, error in lubricator
.../SD250	0.7 ml (0.02 US fl. oz) per day	Red led (each 5 sec)	
Highest grease purge		IP rating	IP 41
.../SD125	4.1 ml (0.13 US fl. oz) per day	Total weight (incl. packaging)	
.../SD250	8.3 ml (0.28 US fl. oz) per day	Drive unit TLSD 1-DK	355 g (12.5 oz)
Ambient temperature range	-20 to 50 °C (-4 to 122 °F)	Power supply	7 V - 35 V / up to 1.5A
Maximum operating pressure	5 bar (75 psi)	Cable length	1 500 mm (59 in.)
Drive mechanism	Electro mechanical	Cable diameter	4.8 mm (0.2 in) max.
Connection thread	G ¹ / ₄	Wire size	24 AWG 7/32 (0.25 mm ²)
Maximum feed line length with:		Wire colours	
grease	Up to 3 meters (10 ft) ¹⁾	White/Brown	+Positive (VCC) / -Negative (GND)
oil	Up to 5 meters (16 ft)	Green/Yellow	Relay contact 1 (NO) / Relay contact 2 (NO)

¹⁾ The maximum feed line length is dependent on ambient temperature, grease type and back pressure created by the application.

SKF SYSTEM 24

Connected single point lubricator

TLDD Series

The SKF SYSTEM 24 portfolio includes a solution for wireless monitoring of automatic single point lubricators the “TLDD series”. The connected single point lubricator, utilizes a web dashboard and interface to monitor the status of each lubricator and change its settings.

Main benefits

- Automatic lubrication helps to increase workplace safety, reliable machine operation and maintenance efficiency
- Scalable solution which is easy to install
- Visibility and control of all lubricators registered in the online platform from one single access point
- Automatic warning and alarm messages that help to ensure reliable lubrication
- Reduce the frequency of inspecting lubrication points in the field
- Empty time overview of all lubricators helps to optimize logistics



The TLDD lubricator is based on the proven automatic single point lubricator from the TLSL series. The difference is that the manual set-up of the lubricator is replaced by wireless control through the online Lubrication Cloud platform. The connectivity is realized by three components which form the TLDD system.

Lubricator

The wireless communication of the lubricator is achieved by utilising encrypted long range network communication inside and outside the factory. The wireless communication allows secure remote monitoring and control of the lubricators, reducing the necessity of frequent visits of the lubricators in the field. Two cartridge sizes and a wide variety of lubricants are available for the lubricator with adjustable emptying times of 1 to 12 months. The electro-mechanical drive system allows installations in all orientations and short feed lines can be used if the lubricator cannot be mounted directly on the machine.

Gateway

The gateway supports the communication between the lubricators and the data cloud. Using the long-range network, each gateway can connect with several different lubricators (there is virtually no limit) that are distributed across the factory. Should one gateway not offer sufficient network coverage, multiple gateways can be used together, creating a scalable system. To enable easy installation without a complex IT setup, the gateway uses the GSM network to communicate with the data cloud. All communication is encrypted to prevent access except by authorized users of the Lubrication Cloud platform. Two gateway options are offered: the standard option for indoor installation, and the heavy-duty IP67 option, which can work in harsh environments, including outdoor (heat, cold, rain, snow, wind, etc.)

Lubrication Cloud platform

The system is monitored and controlled via the Lubrication Cloud platform. The web-interface visualizes the lubricator data in the

cloud and offers intuitive interaction with the lubricator data. The platform can be easily accessed by computers, tablets and mobile devices through the web browser.

Features of the Lubrication Cloud platform

- Access and data consolidation of multiple organizations/sites with a single account
- One platform for your different SKF Connected Lubrication products
- Intuitive web interface for managing TLDD lubricators, including an advanced hierarchy function for grouping assets and organizing the local installation
- Dashboard with summary of lubrication status, allowing the user to track and log the behavior of the installed units over time
- Automatic alarms and email notifications for troubleshooting
- Easy monitoring and changing of settings of each lubricator
- Access management for multiple users
- Batch upload of lubrication points (with Excel.csv files)
- Multilingual interface

The TLDD system consists of different components that need to be ordered separately.



Lubricator drive unit

Each lubrication point requires one drive unit. Different drive unit versions comply with regional communication regulations.



Lubricant cartridge sets

Lubricant cartridge sets are available for a wide range of grease and oil lubricants in two different sizes. The TLDD uses the same cartridge sets and batteries as TLSD lubricators.



Support plate for grease or oil lubrication

The support plate is a mandatory component for each drive unit for installing the lubricator. A support plate for grease lubrication is included with every drive unit with “-DS” suffix. For oil lubrication, a special support plate with none-return valve needs to be ordered separately.



Gateway

The gateways connect a group of lubricators with the cloud of the Lubrication Cloud platform. The gateways are available in matching versions to the drive units.

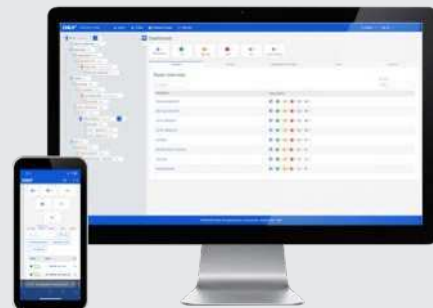

Lubrication Cloud platform

The lubrication cloud platform (www.lubrication-cloud.skf.com) allows registered users to see the status of connected lubricators and control them.

TLDD components

Description	Region	Designation
Lubricator drive-unit	Europe	TLDD 1/EU-DS *
	North and Central America	TLDD 1/US-DS *
	Australia and South America	TLDD 1/AU-DS *
Gateway	Europe	TLDD 1/EU-GAT or TLDD 2/EU-GAT
	North and Central America	TLDD 1/US-GAT or TLDD 2/US-GAT
	Australia	TLDD 1/AU-GAT or TLDD 2/AU-GAT
	South America	TLDD 1/AU-GAT or TLDD 2/LA-GAT

* With support plate TLSD 1-SP included

Note: refer to the Technical data table in the next page for more information on which version to use in your region.

Available lubricants

A wide range of SKF lubricants is available for TLDD lubricators. The cartridge sets are available in two sizes and are supplied with a battery pack. Please see page 179 for more details and specifications.



Connected single point lubricator TLDD Series

Technical data

Lubricator

Grease capacity	
.../SD125 refill set	125 ml (4.2 US fl. oz)
.../SD250 refill set	250 ml (8.5 US fl. oz)
Emptying time	1 to 12 months, user adjustable via Lubrication Cloud Platform
Lowest grease purge	
.../SD125 refill set	0.3 ml (0.01 US fl. oz) per day
.../SD250 refill set	0.7 ml (0.02 US fl. oz) per day
Highest grease purge	
.../SD125 refill set	4.1 ml (0.13 US fl. oz) per day
.../SD250 refill set	8.3 ml (0.28 US fl. oz) per day
Operating temperature range	0 to 50 °C (30 to 120 °F)
Maximum operating pressure	5 bar (75 psi)
Drive mechanism	Electro mechanical
Connection thread	G ¹ / ₄
Maximum feed line length with:	
Grease	Up to 3 meters (10 ft)
Oil	Up to 5 meters (16 ft)
LED status indicators	Green, yellow, red, blue and purple to indicate the lubricator status
Total weight (incl. packaging)	0.34 kg (0.75 lb)
IP rating	IP 65
Battery	Battery pack 4.5 V, 2.7 Ah Alkaline manganese (TLSD 1-BAT)

Regional differentiation

Country availability	See the list below of countries to select the correct regional version. If your country is not listed, please reach out to your SKF local representative for more information.
Europe	Austria, Belgium, Bulgaria, Croatia, Cyprus, Czech Republic, Denmark, Estonia, Finland, France, Germany, Greece, Hungary, Iceland, Ireland, Italy, Latvia, Liechtenstein, Lithuania, Luxembourg, Malta, Netherlands, Norway, Poland, Portugal, Romania, Slovakia, Slovenia, Spain, Switzerland, Sweden, United Kingdom
North and Central America	United States of America, Canada*, Mexico*, Puerto Rico
Australia	Australia, New Zealand
South America	Chile*, Colombia*, Argentina*, Brazil*, Paraguay*, Peru*, Uruguay*
Other regions	Contact your local SKF representative for information

*Pending local radio communications approval - please visit skf.com or contact your local SKF representative to confirm availability.

Standard gateway

Designation	TLDD 1/xx-GAT
Distance to lubricators	Up to 300 m (985 ft) in open factory environments
Number of lubricators	Virtually no limit
Power	100-240 V, 50/60 Hz, plugs for EU, US, UK, AU included
Power over Ethernet	N/A
Operating temperature range	-10 to +60 °C (+14 to +140 °F)
Relative humidity	20 to 90 %, non-condensing
Product dimensions	165 x 133 x 45 mm (6.5 x 5.2 x 1.8 in.)
Total weight (incl. packaging)	0.73 kg (1.6 lb)

Heavy duty gateway

Designation	TLDD 2/xx-GAT
Distance to lubricators	Up to 300 m (985 ft) in open factory environments
Number of lubricators	Virtually no limit
Power	Ethernet Input Power: 37 - 57 VDC, 25 W min. power rating
Power over Ethernet	PoE Standard IEEE 802.3at, PoE adapter available (Input 100-240V, 50/60 Hz, 0.6A max.)
Power adapters *	
TLDD 2/EU-POE	PoE power adapter with EU plug (type E)
TLDD 2/US-POE	PoE power adapter with US plug (type A)
TLDD 2/AU-POE	PoE power adapter with Australian plug (type I)
Operating temperature range	-40 to +70 °C (-40 to +158 °F)
Relative humidity	20 to 90 %, non-condensing
Product dimensions	232 x 199 x 102 mm (9.1 x 7.8 x 4.0 in.)
Total weight (incl. packaging)	1.43 kg (3 lb)
Protection index	IP 67

* A plug adapter or an alternative 3-pin power cable (type C13) may be used to adapt to local requirements.

Gateway and communication

Lubricator and gateway	LoRaWAN®, Long Range Wide Area Network		
Region	Lubricator	Gateway	Frequency range
Europe	EU version	EU version	863-870 MHz
North America	US version	US version	902-928 MHz
Australia, New Zealand	AU version	AU version	915-928 MHz
South America	AU version	LA version *	915-928 MHz
Other regions	Contact SKF		
Gateway	GSM 4G, 3FF micro sim card pre-installed, not exchangeable		
Security	Encrypted communication		

* The TLDD 1/AU-GAT may also be used in this region

Multiple accessories are available for TLDD lubricators. More information can be found on pages 190-191.

Refillable automatic grease dispenser

TLRD series

The TLRD series is a refillable electro-mechanical single-point grease dispenser, which can be reused by simply refilling it with fresh grease and installing with a new battery pack. It brings additional value compared to gas-driven lubricators as it can be operated under variable temperatures, or when the application conditions require a remote mounting (in case of vibration, limited space or hazardous environment), or when a simple filling / refilling process is required.

- Available in 2 sizes (150 and 250 ml)
- To be filled with any compatible grease (it is supplied without lubricant)
- Can be filled and refilled easily with a standard grease gun/pump
- Maximum discharge pressure of 5 bars over the full dispensing period
- Visual inspection is easy through the translucent reservoir
- Normal / abnormal working conditions are indicated by a LED
- Connection nipples and other installation accessories are available
- Suitable for both direct and remote installation



TLRD 1-FA

Ordering details

Designation	Description
TLRD 150	Drive unit kit (150 ml) incl. empty cartridge, drive unit with cap and battery pack
TLRD 250	Drive unit kit (250 ml) incl. empty cartridge, drive unit with cap and battery pack
TLRD 1-FA	Filling adapter (all cartridges)

Technical data

Designation	TLRD 150	TLRD 250
Approx. dimensions	152 × 89 mm (6 × 3.5 in.)	196 × 102 mm (7.7 × 4 in.)
Weight	0.58 kg (1.28 lb)	0.68 kg (1.50 lb)
Grease capacity	150 ml (5.1 fl. oz US)	250 ml (8.5 fl. oz US)
Time setting	Adjustable 1 to 12 months	Adjustable 1 to 12 months
Outlet interface	G½	G½
Ambient temperature range	-20 to +60 °C (-4 to +140 °F)	-20 to +60 °C (-4 to +140 °F)
Operating pressure range	Up to 5 bar	Up to 5 bar
Electrical rating	6V CR-P2 Lithium (1 400 mAh)	6V CR-P2 Lithium (1 400 mAh)
Storage temperature range	0 to 50 °C (32 to 122 °F)	0 to 50 °C (32 to 122 °F)
Drive mechanism	Electro-mechanical	Electro-mechanical
Maximum feed line length	Up to 3 meters (10 ft)	Up to 3 meters (10 ft)
Protection class assembled lubricator	IP 65	IP 65



Electro-mechanical single point automatic lubricators TLMR series

The SKF Automatic Lubricant Dispenser – TLMR – is a single point automatic lubricator designed to supply grease to a single lubrication point. With a relatively high pressure of 30 bars, this lubricator can operate at long distances providing optimum results with difficult-to-reach and unsafe lubrication locations. With a wide temperature range and robust design, the TLMR lubricator is suitable for operating conditions with various levels of temperature and vibration.

- Filled with high quality SKF greases
- Temperature independent dispense rate
- Extended time setting up to 24 months
- Maximum discharge pressure of 30 bar over the whole dispensing period
- Available in two versions: TLMR 101 powered by batteries (standard Lithium AA type) and TLMR 201 powered by 12–24 V DC
- Available with non-refillable cartridges in two sizes: 120 and 380 ml

Typical applications

- Applications requiring high lubricant consumption
- Applications experiencing high vibration in operation
- Excellent water and dust protection makes TLMR suitable for general machinery applications and food processing machinery
- Excellent high temperature performance makes TLMR suitable for engine rooms and hot fan applications
- Excellent low temperature performance makes TLMR suitable for wind turbine applications

SKF DialSet (dialset.skf.com) helps to calculate the correct dispense rate.

Multiple accessories are available for TLMR lubricators. More information can be found on pages 190-191.



Each TLMR is supplied with a strong mounting bracket as standard. The bracket enables the TLMR to be easily mounted on a flat surface.



For ease of use, cartridges are easily exchanged by simply screwing them into the lubricator.



Ordering details

Grease	Description	TLMR 101 refill sets (cartridge and battery)		TLMR 201 cartridges	
		120 ml	380 ml	120 ml	380 ml
LGWA 2	High load, extreme pressure, wide temperature range bearing grease	LGWA 2/MR120B	LGWA 2/MR380B	LGWA 2/MR120	LGWA 2/MR380
LGEV 2	Extremely high viscosity bearing grease with solid lubricants	–	LGEV 2/MR380B	–	LGEV 2/MR380
LGHB 2	High load, high temperature, high viscosity bearing grease	–	LGHB 2/MR380B	–	LGHB 2/MR380
LGHQ 2	High performance, high temperature bearing grease	–	LGHQ 2/MR380B	–	LGHQ 2/MR380
LGFG 2	General purpose food grade (NSF H1) bearing grease	–	LGFG 2/MR380B	–	LGFG 2/MR380
LGWM 1	Extreme pressure, low temperature bearing grease	–	LGWM 1/MR380B	–	LGWM 1/MR380
LGWM 2	High load, wide temperature range bearing grease	–	LGWM 2/MR380B	–	LGWM 2/MR380
LGEP 2	Extreme pressure bearing grease	–	LGEP 2/MR380B	–	LGEP 2/MR380
LGMT 3	All purpose industrial and automotive bearinggrease	–	LGMT 3/MR380B	–	LGMT 3/MR380

Complete sets

TLMR 101/38WA2	Lubricator with 380 ml cartridge filled with LGWA 2 grease, powered by batteries.
TLMR 201/38WA2	Lubricator with 380 ml cartridge filled with LGWA 2 grease, powered by 12-24 V DC

TLMR pump

TLMR 101	Lubricator powered by batteries
TLMR 201	Lubricator powered by 12-24 V DC, plug M12-A (not included)

Technical data

Designation	TLMR 101 and TLMR 201		
Grease capacity	120 ml (4.1 US fl. oz) 380 ml (12.8 US fl. oz)	Maximum operating pressure	30 bar (435 psi)
Emptying time	User adjustable: 1,2,3,6,9,12, 18, 24 months or purge	Drive mechanism	Electro mechanical
Lowest setting		Connection thread	G ¹ / ₄ female
120 ml cartridge	0.16 ml (0.005 US fl. oz) per day	Maximum feed line length¹⁾	Up to 5 meters (16 ft)
380 ml cartridge	0.5 ml (0.016 US fl. oz) per day	LED status indicators	
Highest setting		Green LED (every 8 sec)	OK
120 ml cartridge	3.9 ml (0.13 US fl. oz) per day	Green and red LED (every 8 sec)	Almost empty
380 ml cartridge	12.5 ml (0.42 US fl. oz) per day	Red LED (every 8 sec)	Error
Purge	31 ml (1 US fl. oz) per hour	Protection class	
Ambient temperature range	–25 to +70 °C (–13 to +158 °F)	DIN EN 60529	IP 67
		DIN 40 050 Teil 9	IP 6k9k
		Power	
		TLMR 101	4 AA Lithium batteries
		TLMR 201	12 -24 Volt DC via M12-A connection

¹⁾ The maximum feed line length is dependent on ambient temperature, grease type and back pressure created by the application.

Ready-to-use centralised lubrication system

Multipoint automatic lubricators TLMP series

The multipoint automatic lubricators are intended for reliable relubrication of multiple lubrication points. This sturdy automatic lubrication system is packaged as a complete kit, including the lubricator, required tubing and connectors. Designed to supply from one to eighteen lubrication points, the TLMP series features pluggable outlets and is easy to install and program via its keypad with LED display.



Featuring a reservoir capacity of nearly one litre, this versatile lubricator has a stirring paddle to prevent grease separation, making it suitable for more lubricants. With its high IP protection rating, the durable TLMP series is vibration resistant, withstands equipment washdowns and prevents contamination ingress. Also, the unit enables machine steering to temporarily disable lubrication by removing power.

TLMP series advantages

- Easy to install and program
- Complete kit
- Suitable for one to eighteen lubrication points
- Low-level and malfunction alarms; remote notification possible
- Machine steering by removing power
- Available in versions with different voltages
- Developed for industrial applications, as well as agricultural and off-road vehicles



The TLMP series are supplied complete with the following items

TLMP 1008	TLMP 1018	
1 ×	1 ×	Pump
1 ×	1 ×	Fitting material for the pump unit
2 ×	2 ×	Electrical connectors
20 m (65 ft)	50 m (164 ft)	plastic pipe Nylon, 6 × 1.5 mm
8 ×	18 ×	Straight tube connectors for application G ^{1/8}
8 ×	18 ×	Tube connectors plugs
7 ×	17 ×	Outlet closure plugs

Filler nipple

Replaces standard grease nipple for quicker lubricant replenishment using filler pump. (LAGF 1-H)

Flexible hose with filler nipple

Replaces standard grease nipple for quicker lubricant replenishment using filler pump. (LAGF 1-F)

LAGF 1-H



LAGF 1-F



Technical data

Designation TLMP 1008 and TLMP 1018

Number of lubrication outlets

TLMP 1008 1–8
TLMP 1018 1–18

Suitable grease consistency NLGI 2, 3

Maximum pressure 205 bar (2970 psi)

Maximum distance length to lubrication point 5 m (16 ft)

Dispense rate 0.1 - 40 cm³/day (0.003 -1.35 US fl.oz./day) per outlet

Output pump element Approx. 0.2 cm³ (per cycle), approx. 1.7 cm³ (per minute)

Reservoir size 1 litre

Useable reservoir volume Approx. 0.5–0.9 litres (17–30 US fl.oz.)

Filling Via hydraulic lubrication fitting R¹/₄

Installation position Vertical (max deviation ±5°)

Power Supply Connector EN 175301-803 DIN 43650/A

Alarms

blocked feed lines, empty reservoir internal and external

External steering

By disconnecting power supply

Ambient temperature

–25 to +70 °C (–13 to +160 °F)

IP rating

IP 67

Lubrication tubes

TLMP 1008 20 m (65 ft), 6 × 1.5 mm, Nylon
TLMP 1018 50 m (164 ft), 6 × 1.5 mm, Nylon

Weight

Approx. 6 kg (13 lb)

Ordering details 8 outlets











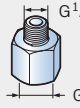

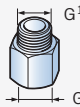

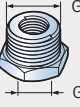
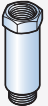
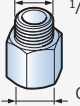
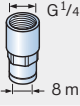
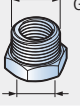

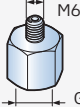

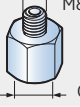
TLMP 1008/24DC 24 V DC (–20/+30%)
TLMP 1008/120V 120 V AC 60 Hz (±10%)
TLMP 1008/230V 230 V AC 50 Hz (±10%)

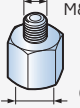
Ordering details 18 outlets

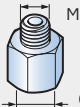
TLMP 1018/24DC 24 V DC (–20/+30%)
TLMP 1018/120V 120 V AC 60 Hz (±10%)
TLMP 1018/230V 230 V AC 50 Hz (±10%)

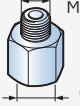

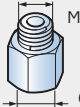
Accessories

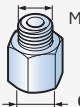
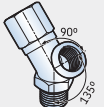
A full range for enhanced versatility of SKF automatic lubricators



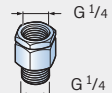

Connectors			Connectors		
	LAPA 45 ● ● ●	Angle connection 45°		LAPN 1/8 ● ● ●	Nipple G ^{1/4} – G ^{1/8}
	LAPA 90 ● ● ●	Angle connection 90°		LAPN 1/4 ● ● ●	Nipple G ^{1/4} – G ^{1/4}
	LAPE 35 ● ● ●	Extension 35 mm		LAPN 1/2 ● ● ●	Nipple G ^{1/4} – G ^{1/2}
	LAPE 50 ● ● ●	Extension 50 mm		LAPN 1/4 UNF ● ● ●	Nipple G ^{1/4} – 1/4 UNF
	LAPF F ^{1/4} ● ●	Tube connection female G ^{1/4}		LAPN 3/8 ● ● ●	Nipple G ^{1/4} – G ^{3/8}
	LAPF M ^{1/8} S ●	Tube connection male G ^{1/8} for 6 × 4 tube		LAPN 6 ● ● ●	Nipple G ^{1/4} – M6
	LAPF M ^{1/4} S ●	Tube connection male G ^{1/4} for 6 × 4 tube		LAPN 8 ● ● ●	Nipple G ^{1/4} – M8
	LAPF M ^{1/8} ● ●	Tube connection male G ^{1/8}		LAPN 8x1 ● ● ●	Nipple G ^{1/4} – M8 × 1
	LAPF M ^{1/4} ● ●	Tube connection male G ^{1/4}		LAPN 10 ● ● ●	Nipple G ^{1/4} – M10
	LAPF M ^{1/4} SW ● ● ●	Extra strong tube connection male G ^{1/4}		LAPN 10x1 ● ● ●	Nipple G ^{1/4} – M10 × 1
	LAPF M ^{3/8} ● ●	Tube connection male G ^{3/8}		LAPN 12 ● ● ●	Nipple G ^{1/4} – M12
	LAPG 1/4 ● ● ●	Grease nipple G ^{1/4}		LAPN 12x1.5 ● ● ●	Nipple G ^{1/4} – M12 × 1.5
	LAPM 2 ● ● ●	Y-connection			

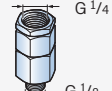
- SKF LAGD Series
- SKF TLSD Series
- SKF TLMR Series

Non return valves (for oil applications)

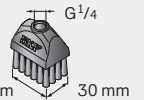
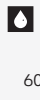
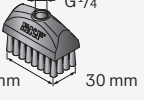
		LAPV 1/4	Non-return valve G 1/4
		• • •	
		LAPV 1/8	Non-return valve G 1/8
		• • •	



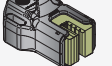



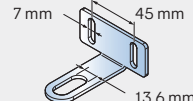
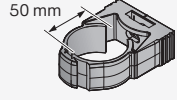
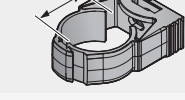
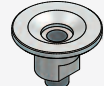
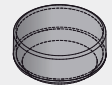

Brushes (for oil applications)

		LAPB 3x4E1	Brush 30 × 40 mm
		• • •	
		LAPB 3x7E1	Brush 30 × 60 mm
		• • •	
		LAPB 3x10E1	Brush 30 × 100 mm
		• • •	
		LAPB 5-16E1	Elevator brush, 5–16 mm gap
		• •	

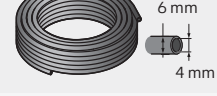
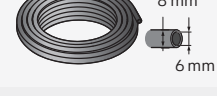
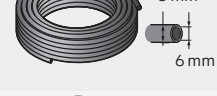

LAPB 5-16/2K
Elevator kit for 5, 9 or 16 mm rail

Mounting and protecting devices and extras

	LAPC 13	Bracket
	•	
	LAPC 50	Clamp
	•	
	LAPC 63	Clamp
	•	
	LAPP 4	Protection base
	•	
	LAPP 6	Protection cap
	•	
	LAPT 1000	Flexible tube, 1 000 mm long, 8 × 6 mm
	• •	
	LAPT 5000	Flexible tube, 5 000 mm long, 8 × 6 mm
	• •	
	LAPT 1000S	Extra strong flexible tube, 1 000 mm long, 6 × 4 mm
	•	
	LAPT 5000S	Extra strong flexible tube, 5 000 mm long, 6 × 4 mm
	•	
	LAPT 1000SW	Extra strong flexible tube, 1 000 mm long, 8 × 6 mm
	• • •	
	LAPT 5000SW	Extra strong flexible tube, 5 000 mm long, 8 × 6 mm
	• • •	
	TLMR 201-1	Cable plug M12x1 for TLMR 201, type M12-A
	•	
	TLSD 1-BAT	Alkaline battery pack
	•	
	TLSD 1-BATC	Lithium battery pack
	•	

Manual grease dispensing tools



A basic element of lubrication plans

The main pitfall of manual lubrication is ensuring accuracy and top cleanliness. Lubricant film in the application can be over 40 times thinner than the smallest visible particle. The SKF range of manual lubrication tools is designed to help you with the storage, handling, dosing and supplying of lubricants for your machinery in a clean and easy way.

A comprehensive range to meet your needs

Grease guns

SKF Grease guns are suitable for agricultural, industrial, automotive and construction industries amongst others. All of them are equipped with a grease filling fitting. This fitting enables the use of SKF Grease filler pumps to refill the guns with loose grease, thus keeping contaminants out of the grease.

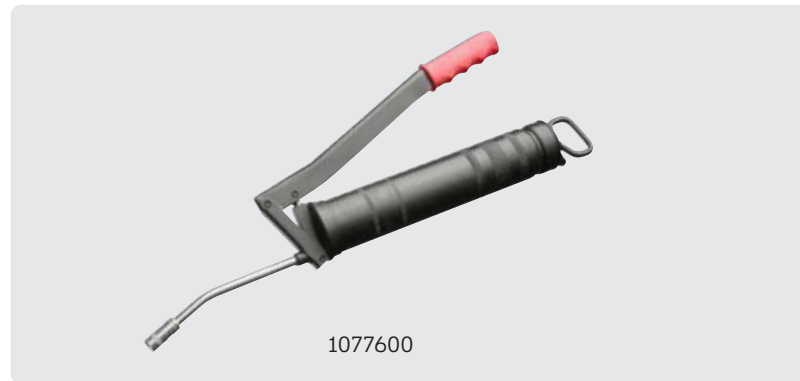
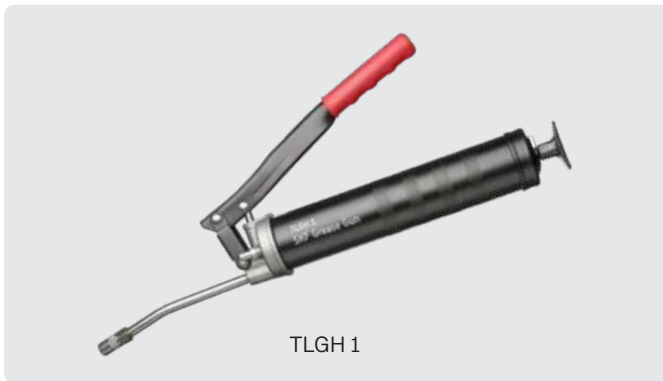

Easy grease filling

Grease guns TLGH 1 and 1077600

The SKF Grease Guns are ideal for agricultural, industrial and construction industries and for private use. The SKF Grease Guns are delivered with a 175 mm (6.9 in.) long extension pipe with hydraulic gripping nozzle.

- For use with cartridges and loose grease
- Knurled body for firm and safe grip
- High quality steel is dent-resistant for easy cartridge loading
- Special piston design for smooth emptying of cartridges
- Volume/stroke
 - TLGH 1: 0.9 cm³ (0.055 in.³)
 - 1077600: 1.5 cm³ (0.092 in.³)

Selection chart and technical data – SKF Grease guns

Designation	TLGH 1	1077600	1077600/SET	LAGH 400
Drive	Manual	Manual	Manual	Manual One hand
Maximum pressure	400 bar (5 800 psi)	400 bar (5 800 psi)	400 bar (5 800 psi)	300 bar (4 350 psi)
Volume per stroke	Approx. 0.9 cm ³ (0.05 in. ³)	Approx. 1.5 cm ³ (0.09 in. ³)	Approx. 1.5 cm ³ (0.09 in. ³)	Approx. 0.46 cm ³ (0.03 in. ³)
Weight	1.5 kg (3.3 lb)	1.5 kg (3.3 lb)	Complete: 2.4 kg (5.3 lb)	1.3 kg (2.9 lb)
Reservoir	Loose grease (ca. 500 cm ³) or grease cartridges.	Loose grease (ca. 500 cm ³) or grease cartridges.	Loose grease (ca. 500 cm ³) or grease cartridges.	Loose grease (ca. 500 cm ³) or grease cartridges.
Discharge pipe length	175 mm (6.9 in.)	175 mm (6.9 in.)	175 mm (6.9 in.)	-
Flexible hose length	-	-	-	300 mm (12 in.)
Accessories	1077601	1077601	1077601	1077601
Carrying case dimensions	-	-	530 × 85 × 180 mm (20.9 × 3.4 × 7.0 in)	-

Note: 1077601: Flexible 500 mm (19.7 in.) long pressure hose with hydraulic gripping nozzle.



1077600/SET



LAGH 400

Easy grease filling with one hand

Grease gun LAGH 400

Suitable for grease filling by grease filler pumps and also suitable for grease cartridges. Ergonomic design, flexible hose and possibility to mount the hose in both vertical and horizontal position make it easy to use.

- Easy-to-use: only one hand is needed to operate the gun
- Refillable: grease filling nipple and de-airing valve allow filling up by filler or grease pump
- Heavy duty: operating pressure up to 300 bar (4 350 psi)
- Flexible hydraulic type hose: can be bent, can be mounted both horizontally and vertically on the gun

1077600 H

The 1077600 is also available with a with 300 mm (12 in.) high pressure hose with a hydraulic gripping nozzle

1077600/SET

The 1077600 is also available as a complete set. Set includes: Extension pipe, Snap-on high pressure hose, Snap-on extension pipe with cardan nozzle, Snap-on extension pipe for flat-head grease fittings (Ø16 mm), Female and pointed nozzle

Manual grease dispensing tools

Reinvented technology and reliability in a durable design

Battery driven grease gun TLGB 21

Developed to maximize lubrication efficiency, the TLGB 21 integrates advanced technology and a robust design for exceptional performance in a wide variety of lubrication tasks. Designed with an integrated grease meter, it ensures precise lubrication, preventing the risk of over- or under-lubrication.

The durable, ergonomic design with a convenient four-point stand makes it comfortable and convenient to operate, and the 20-volt, lithium-ion battery gives a longer operating time. Suitable for a variety of manual lubrication tasks, the TLGB 21 can be used to lubricate bearings and machines in industrial and manufacturing environments, as well as agricultural and construction applications.



The TLGB 21 is equipped with a clear display showing battery charge level, remaining grease level, amount of grease dispensed, pump/motor speed, and blocked lubrication points. This versatile tool offers two flow rates low and high and can dispense up to 24 grease cartridges per battery charge. The optional high-capacity battery will even allow to dispense up to 40 grease cartridges and allows extended periods between charging. With the power to deliver pressures of up to 700 bar (10 000 psi) and a built-in light to illuminate your work area, the TLGB 21 ensures precise, efficient, and reliable lubrication at all times.

Precise lubrication with integrated grease meter

The TLGB 21's grease meter provides precise control over lubrication, preventing both over- and under-lubrication. Accurate lubrication is crucial, as under-lubrication can lead to premature bearing failure or contamination, while over-lubrication wastes grease and can cause serious issues. In fast-moving equipment like electric motors, excess lubricant can generate high temperatures, damage seals, and allow contaminants to enter. High temperatures also significantly reduce lubricant life, increasing operational costs.

Four-point stand

Keeps grease gun upright for easy handling

What is in the box?

- Battery driven grease gun with grease tube assembly
- 2.5 Ah Li-ion battery and charge
- Carrying strap
- Lubrication hose
- Carry case



Integrated grease meter

Monitors and tracks the exact amount of grease dispensed, ensuring optimal lubrication.

Two-speed flow rate

Adjusts from low-volume to high-volume flow, tailoring lubrication to your specific application needs.

Battery charge display

Shows the charge level of the lithium-ion battery.

Cartridge grease level indicator

Indicates the grease level inside the cartridge.



Technical data			
Designation	TLGB 21/230V and TLGB 21/110V		
Display	Grease meter	Length of hose	1 220 mm (48 in)
	Battery capacity gauge		Battery type
Grease output	Cartridge grease level	Battery output	20 V DC maximum (without workload)
	Alert of blocked fittings	Battery capacity	2 500 mAh
Maximum operating pressure	Alert of loss of prime	Voltage charger, V/Hz	
	Low speed setting	TLGB 21/230V	200–240 V/50–60 Hz
Maximum peak pressure	110 g/min. (3.8 oz/min.) at 70 bar pressure	TLGB 21/110V	110–120 V/60 Hz
	170 g/min. (6.0 oz/min.) at 70 bar pressure	Carrying case dimensions (W x D x H)	645 x 390 x 140 mm (25.4 x 14.4 x 5.51 in)
Cartridges per battery charge	400 bar (6 000 psi)	Weight	3.36 kg (7.4 lb)
	700 bar (10 000 psi)	Total weight (incl.case)	6.9 kg (15.21 lb)
	24 cartridges (free flow, low speed)		
	40 cartridges with optional 4.0 Ah battery		

Manual grease dispensing tools

Simplify and reduce the time spent in your lubrication process

Battery driven grease gun TLGB 1262-E

Designed to minimize the burden of manual lubrication, the 12V battery driven grease gun TLGB 1262-E simplifies and speeds up the lubrication process, making it easier to properly maintain equipment. The three-point base keeps the tool upright and stable without being bulky, allowing access to tight areas and reducing operator fatigue when lubricating.

Featuring an updated powertrain, handle design and enhanced features it is easy to handle and convenient for occasional or daily use, suitable for agricultural, automotive, construction, general maintenance and industrial applications.

- Durable simplicity
- Opens stuck fittings that otherwise would require replacement if using a manual grease gun
- Built-in LED illuminates the work area
- Trapped air inside of the grease gun can be easily removed with the vent valve to restore priming
- Dual-lip follower design enables bulk or cartridge grease delivery and eliminates grease bypass
- High-pressure hose with protective anti-kink spring guards on each end
- Easily and cleanly filled from drums with filler pumps
- Battery charge LED indicator



Technical data

Designation	TLGB 1262-E
Grease output	95 g/min (3.2 oz/min) at 70 bar pressure
Maximum operating pressure	241 bar (3 500 psi)
Maximum peak pressure	551 bar (8 000 psi)
Cartridges per battery charge	2.25 cartridges (200 bar counter pressure) 6.5 cartridges (free flow)
Length of hose	760 mm (30 in)
Battery type	Li-Ion
Battery output	12 V
Battery capacity	1 500 mAh
Voltage charger, V/Hz	200–240 V/ 50–60 Hz
Carrying case dimensions	590×108×373 mm (23.2×4.3×14.7 in)
Weight (incl. battery)	2.5 kg (5.5 lb)
Total weight (incl. case)	6 kg (13.2 lb)



For intensive use in challenging environments

Battery driven grease gun TLGB 1886-E

The 20V battery driven grease gun TLGB 1886-E offers the key features you need for tough jobs. The versatility of the two-speed design enables you to address all lubrication points with a single tool, protecting your equipment from costly repair and downtime. The tool's high-ratio gearing will move large quantities of grease quickly when needed, while its low gearing supports deliveries of up to 700 bar.

Thanks to its ergonomic rugged design, high-performance motor positioning and efficient handling, the TLGB 1886-E has been designed to withstand the intensive use found in demanding industries such as agriculture, construction, automotive, trucking, heavy equipment and wind energy.

- High performance for intensive use
- Built-in LED illuminates the work area
- LED indicators identify loss of prime, empty cartridge or blocked fittings
- Trapped air inside of the grease gun can be easily removed with the vent valve to restore priming
- High-pressure hose with protective anti-kink spring guards on each end
- Heavy-duty composite body with protective rubber overmold
- Easily and cleanly filled from drums with filler pumps
- Battery charge LED indicator



Technical data

Designation	TLGB 1886-E
Grease output	
Low speed setting	100 g/min (3.5 oz/min) at 70 bar pressure
High speed setting	284 g/min (10 oz/min) at 70 bar pressure
Maximum operating pressure	550 bar (8 000 psi)
Maximum peak pressure	700 bar (10 000 psi)
Cartridges per battery charge	8.6 cartridges (200 bar counter pressure, low speed) 18 cartridges (free flow)
Length of hose	1220 mm (48 in)
Battery type	Li-Ion
Battery output	20 V
Battery capacity	2 500 mAh
Voltage charger, V/Hz	200–240 V / 50–60 Hz
Carrying case dimensions	650×140×393 mm (25.6×5.5×15.5 in)
Weight (incl. battery)	3.4 kg (7.5 lb)
Total weight (incl. case)	7.9 kg (17.4 lb)



Optimum cleanliness when filling your grease guns

Grease filler pumps LAGF series

Best lubrication practices say that each type of grease requires an individual grease gun and the refilling has to be a clean process. SKF Grease Filler Pumps are designed to help achieve this goal.

- Quick filling: low pressure high stroke volume
- Easy installation: all necessary items are included
- Reliable: tested and approved for all SKF greases
- Appropriate as a complement for SKF Bearing packer VKN 550

Technical data

Designation	LAGF 18	LAGF 50
Maximum pressure	30 bar (430 psi)	30 bar (430 psi)
Volume/stroke	approx. 45 cm ³ (1.5 US fl. oz)	approx. 45 cm ³ (1.5 US fl. oz)
Suitable drum dimensions:		
inside diameter	265–285 mm (10.4–11.2 in.)	350–385 mm (13.8–15.2 in.)
maximum inside height	420 mm (16.5 in.)	675 mm (26.6 in.)
Weight (approx.)	4 kg (8.8 lb)	6 kg (13.2 lb)

Accurate grease quantity measurement

Grease meter LAGM 1000E

The SKF Grease Meter LAGM 1000E accurately measures grease discharge in volume or weight in metric (cm³ or g) or US units (US fl. oz or oz), making conversion calculations unnecessary.

- Suitable for most NLGI 0-3 greases
- A rubber sleeve protects the electronics in case of impact and is also oil and grease resistant
- The backlit LCD displays large and clear-to-read digits
- Maximum pressure of 700 bar (10 000 psi)
- Compact and lightweight design
- Corrosion-resistant aluminium housing
- Fits with all SKF manual grease guns
- Fixed installation in conjunction with a lubrication system possible.



Technical data

Designation	LAGM 1000E
Housing material	Aluminium, anodised
Weight	0.4 kg (0.88 lb)
IP rating	IP 67
Suitable greases	NLGI 0 to NLGI 3
Maximum operating pressure	700 bar (10 000 psi)
Maximum grease flow	1 000 cm ³ /min (34 US fl. oz/min)
Thread connections	M10x1
Display	Lit LCD (4 digits / 9 mm)
Accuracy	±3% from 0 to 300 bar, ±5% from 300 to 700 bar
Selectable units	cm ³ , g, US fl. oz or oz
Display lamp auto switch off	15 seconds after last pulse
Battery type	1 × 1.5 V AA Alkaline
Unit auto switch off	Programmable



For high volume requirements

Grease pumps LAGG series

SKF manual and air-operated grease pumps are designed to supply large amounts of grease. This is useful when large housings have to be filled or when numerous points have to be lubricated. They are also suitable for topping up centralised lubrication systems reservoirs.

- Full range: pumps available for 18, 50 or 180 kg (39, 110 or 400 lb) grease drums
- High pressure: maximum of 420 bar (6 090 psi) for air-driven models
- Reliable: tested and approved for SKF greases
- Easy and ready to install
- 3.5 m (11.5 ft) of tubing included

Accessories

Designation	Description
LAGT 18-50	Trolley for 18 kg (40 lb) cans and 50 kg (110 lb) drums
LAGT 180	Trolley for drums up to 200 kg (440 lb)



Technical data

Designation	LAGG 18M	LAGG 18AE	LAGG 50AE	LAGG 180AE
Description	Grease pump for 18 kg (39.6 lb) drums	Mobile grease pump for 18 kg (39.6 lb) drums	Grease pump for 50 kg (110 lb) drums	Grease pump for 180 kg (396 lb) drums
Power source	Manual	Air-pressure	Air-pressure	Air-pressure
Max. pressure	500 bar (7 250 psi)	420 bar (6 090 psi)	420 bar (6 090 psi)	420 bar (6 090 psi)
Suitable drum	265–285 mm (10.4–11.2 in.)	265–285 mm (10.4–11.2 in.)	350–385 mm (13.8–15.2 in.)	550–590 mm (21.7–23.2 in.)
Mobility	Stationary	Trolley included (LAGT 18-50)	Stationary	Stationary
Maximum flow rate	1.6 cm ³ /stroke (0.05 US fl. oz)	200 cm ³ /min. (6.8 US fl. oz)	200 cm ³ /min. (6.8 US fl. oz)	200 cm ³ /min. (6.8 US fl. oz)
Suitable grease NLGI class	000–2	0–2	0–2	0–2
Weight (approx.)	6 kg (13.2 lb.)	18 kg (39.7 lb.)	12 kg (26.5 lb.)	19 kg (41.8 lb.)

Accessories

Contamination free grease filling

Bearing packer VKN 550

The sturdy and easy-to-use Bearing packer VKN 550 is designed to completely fill open bearings such as tapered roller bearings. They can be used with a standard grease gun, air-operated grease pump or grease filler pump.

- Flushes the grease right between the rolling elements
- Closed system: the cover lid prevents ingress of dirt

Note: Can be used in conjunction with Grease filler pumps LAGF series.



Technical data

Designation	VKN 550
Bearing range	
inner diameter (d)	19 to 120 mm (0.7 to 4.7 in.)
outer diameter (D)	max. 200 mm (7.9 in.)

Renew or upgrade your equipment

Grease nozzles LAGS 8

The SKF Grease Nozzles LAGS 8 kit provides practical accessories for daily lubrication, such as connectors, couplings and nozzles that are most widely used in the industry.



Technical data

Designation	LAGS 8
Maximum working pressure	400 bar (5 800 psi)
Minimum burst pressure	800 bar (11 600 psi)
Carrying case dimensions	530 × 85 × 180 mm (20.9 × 3.4 × 7.0 in.)

Kit contents

LAGS 8	Quantity
Straight pipe 180 mm and nozzle (DIN 71412)	1
Hose with nozzle (DIN 71412)	1
Tube with nozzle for bottom head grease fittings (DIN 3404)	1
Tube with nozzle for Flush type grease fittings and plastic transparent cover (DIN 3405)	1
Grease fitting M10x1-G ^{1/8}	1
Grease fitting M10x1- ^{1/8} -27NPS	1
Nozzle (DIN 71412)	2

The link to your lubrication points

Grease nipples LAGN 120

The LAGN 120 grease fitting kit contains a full range of 120 standardised conical grease fittings made of precision steel, zinc plated, hardened and blue chromated.



Technical data

Designation	LAGN 120
Maximum working pressure	400 bar (5 800 psi)
Minimum burst pressure	800 bar (11 600 psi)

Kit contents

Grease fitting type	Quantity	Grease fitting type	Quantity
M6x1 straight	30	M10x1 45°	5
M8x1 straight	20	G ^{1/8} 45°	5
M10x1 straight	10	M6x1 90°	5
G ^{1/8} straight	10	M8x1 90°	10
M6x1 45°	5	M10x1 90°	5
M8x1 45°	10	G ^{1/8} 90°	5

For a seamless and efficient greasing experience

Grease coupler LAGC S

The grease coupler improves safety and simplifies the manual lubrication process. Featuring one-handed operation, the coupler remains attached to the fitting during lubrication. Its reverse-jaw design holds the coupler securely to the seat and eliminates grease spillage.



- Effortless coupling and uncoupling, even under pressure
- Locking and quick-release mechanism that creates a leak-proof seal
- Compatible with standard grease guns, transfer pumps, and typical industrial grease fittings
- Maximum working pressure 550 bar (8 000 psi)

Technical data

Designation	Description
Designation	LAGC S
Thread (female)	M10X1
To be used in grease fitting	DIN 71412, SAE J534
Max. working pressure	550 bar (8 000 psi)
Total length	92 mm (3.62 in.)
Weight	196 g (0.448 oz.)

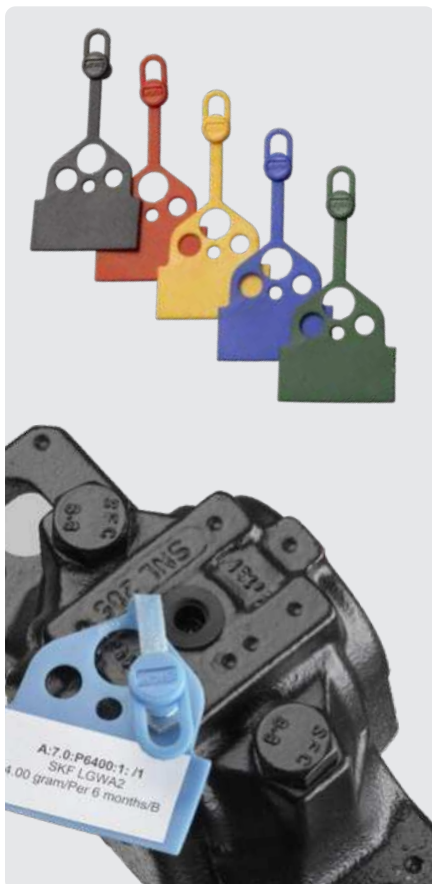

Proper identification of your lubrication points

Grease fitting caps and tags TLAC 50

In conjunction with the SKF Lubrication Planner software, grease fitting caps and tags offer a complete solution to protect lubrication fittings from external contamination and simultaneously allow for proper identification.

Technical data

Description	Value
Label dimensions	45 × 21 mm (1.8 × 0.8 in.)
Material	LLDP + 25% EVA
Temperature range	from -20 to +80 °C (-5 to +175 °F)
Suitable for grease fitting sizes	G ¹ / ₄ , G ¹ / ₈ , M6, M8, M10 and grease fitting head

Kits contents

Kit designation	Description
TLAC 50/B	50 blue caps and tags + 2 printable stickers sheets
TLAC 50/Y	50 yellow caps and tags + 2 printable stickers sheets
TLAC 50/R	50 red caps and tags + 2 printable stickers sheets
TLAC 50/G	50 green caps and tags + 2 printable stickers sheets
TLAC 50/Z	50 black caps and tags + 2 printable stickers sheets
TLAT 10	10 printable stickers sheets

Accessories

Ultrasonic sensor improves maintenance practices when re-lubricating bearings

Ultrasound lubrication checker TLGU 10

Designed for maintenance technicians, the TLGU 10 uses ultrasonic technology to improve manual re-lubrication. When connected to a grease gun, the intuitive device helps a technician to dispense the correct amount of lubricant into a bearing. By overcoming the problems associated with over- or under-lubrication, it can help to extend bearing life. The device is recommended for a range of bearing applications including electric motors, pumps, fans, compressors and conveyors.

- **Easy to use:** The TLGU 10 is supplied as a kit. Combining sound with visual displays helps the technician to re-lubricate with maximum accuracy.
- **Saves cost:** As well as avoiding over-lubrication – and excess grease costs – the added accuracy improves the reliability of a customer's assets.
- **Increases reliability and accuracy:** Rather than using theoretical models or experience, a technician is given accurate, real-time guidance on the progress of the re-lubrication process.
- **Extends bearing life:** Accurate re-lubrication leads to optimum bearing performance, which reduces the likelihood of wear and failure.



Note: The grease gun is not included in the scope of delivery of TLGU 10.



Technical data

Designation TLGU 10

General

Description	Ultrasound lubrication detector
Measurement channel	1 channel via a 7 pole LEMO connector
Display	160x128 pixels Color OLED
Keyboard	5 function keys
Measuring range	-6 to 99.9 dB μ V (reference 0 dB = 1 μ V)
Resolution	0.1 dB
Measurement	Bandwidth 35 to 42 kHz
Signal amplification	+30 to +102 by step of 6 dB

Audio

Amplification	5 adjustable positions in steps of 6 dB
Maximum output	+83 dB SPL with supplied headset
Headset	25 dB NRR Peltor HQ headset
Headset connector	Stereo jack connector of 6.35 mm (1/4 in)

Power

Battery	2 AA batteries
Battery life	7 hours

Environmental

Operating temperature	From -10 to +50 °C (14 to 122 °F)
IP rating	IP42

Mechanical

Housing material	ABS
Dimensions instrument	158 × 59 × 38.5 mm (6.22 × 2.32 × 1.51 in)
Flexible rod length	445 mm (17.51 in)
Weight instrument	164 g (5.78 oz)
Carrying case dimensions	530 × 110 × 360 mm (20.9 × 4.3 × 14.2 in)
Total weight (incl. case, sensor and 2 AA batteries)	3 kg (6.6 lb)

Oil inspection and dispensing



Automatic adjustment for optimal lubricating oil level

Oil levellers LAHD series

SKF LAHD 500 and LAHD 1000 oil levellers are designed to automatically compensate oil evaporation and leakages under running conditions. This helps in maintaining the correct oil level within a bearing housing, gear box, crankcase, or similar oil bath application. The SKF LAHD series optimises machine performance and increases their service life. Furthermore, they enhance the possibility of an accurate visual inspection of the oil level.

- Optimally maintained oil level
- Extended inspection interval
- Easy visual inspection
- Compensation for evaporation losses

Typical applications

- Oil lubricated bearing housings
- Gear boxes
- Crankcases

Technical data

Designation	LAHD 500 / LAHD 1000
Reservoir volume	
LAHD 500	500 ml (17 US fl. oz)
LAHD 1000	1 000 ml (34 US fl. oz)
Boundary dimensions	
LAHD 500	Ø91 mm × 290 mm high (3.6 × 11.4 in.)
LAHD 1000	Ø122 mm × 290 mm high (4.8 × 11.4 in.)
Allowed temperature range	-20 to +70 °C (-5 to +158 °F)
Length of connecting tube	600 mm (23.5 in.)
Connection thread	G ^{1/2}
Suitable oil types	Mineral and synthetic oils



Oil inspection and dispensing



A proper solution for oil handling

Oil handling containers LAOS series

LAOS series is comprised of an extensive assortment of drums and dispensing lids ideal for the storage and administration of fluids and oil lubricants. The lids are available in ten different colours to fit colour coded identification systems.

- Enables easier, safer and cleaner lubrication
- Allows for accurate oil consumption control
- Improves health and safety due to oil spillage minimisation
- Heat and chemically resistant
- Drum and lid threads provide tight, quick and easy assembly
- Quick closing spouts
- Vacuum valve for enhanced spilling control



Mini spout

Ideal where the reservoirs to be filled have small filling holes. Outlet diameter is approx. 7 mm (0.28 in.)



Stretch spout

Ideal for precise pouring tasks and difficult to access points. The 12 mm (0.48 in.) outlet is ideal for viscosities up to ISO VG 220.



Stumpy spout

Due to the wide opening of 25 mm (1 in.), ideal for high viscosities and/or when a high flow is required.



Utility / Storage lid

Two main uses: Quick pouring if necessary and assembly of pump onto a 3.5 or 10 L drum (0.8, 1.3 or 2.6 US Gal).



Contents label

For proper marking of drum contents (36 blank and printable labels on 3 sheets))

LAOS series lids					
Colour	Mini spout	Stretch spout	Stumpy spout	Utility / Storage lid	Contents label
Tan	LAOS 09057	LAOS 09682	LAOS 09705	LAOS 09668	LAOS 36L
Grey	LAOS 09064	LAOS 09699	LAOS 09712	LAOS 09675	
Orange	LAOS 09088	LAOS 09798	LAOS 09729	LAOS 09866	
Black	LAOS 09095	LAOS 09804	LAOS 09736	LAOS 09873	
Dark green	LAOS 09101	LAOS 09811	LAOS 09743	LAOS 09880	
Green	LAOS 09118	LAOS 09828	LAOS 09750	LAOS 09897	
Blue	LAOS 09125	LAOS 09835	LAOS 09767	LAOS 09903	
Red	LAOS 09132	LAOS 09842	LAOS 09774	LAOS 09910	
Purple	LAOS 09071	LAOS 09392	LAOS 09388	LAOS 09408	
Yellow	LAOS 09194	LAOS 62437	LAOS 64936	LAOS 62451	



Drums

Designed with wide necks and a standard thread size. Fits any LAOS lid. Available in 3 different sizes.



Pumps

Standard pump suitable for viscosities up to ISO VG 460. High flow (approx. 14 strokes per litre/US quart). High viscosity pump for viscosities up to ISO VG 680. High efficiency with approx. 12 strokes per litre/US quart. As a protection against airborne contaminants during the pumping process, a 10 micron breather is available. For both pumps an anti-drip long discharge hose of 1.5 m (4.9 ft) and reducer nozzles are available.



Hose extensions

Designed to extend the reach of the lids. Two different versions available for stumpy and stretch lids. The stretch version's length can be adjusted by removing the fitting and cutting it down to the desired size.

LAOS series drums

Designation	
LAOS 63595	3 litre drum (0.8 US gal)
LAOS 63618	5 litre drum (1.3 US gal)
LAOS 66251	10 litre drum (2.6 US gal)

LAOS series pumps

Designation	
LAOS 62568	High viscosity pump (to fit LAOS utility lids)
LAOS 09423	Breather for high viscosity pump
LAOS 62567	Standard Pump (to fit LAOS utility lids)
LAOS 09422	Pump reducer nozzle

LAOS series spouts

Designation	
LAOS 67265	Stumpy spout hose extension
LAOS 62499	Stretch spout hose extension

Storage tools



Keep your oil clean from the beginning

Oil conditioning station

The reliability of oil lubricated machinery depends very much on the cleanliness of the oil. Given its liquid nature, oil easily gets contaminated from the moment it is delivered up to application in the machine.

An oil conditioning station helps to clean the oil while it is being loaded into the tanks, during delivery, and maybe most importantly while it remains in the tank. A continuous filtration process helps to ensure that the desired cleanliness level is achieved. Finally, an additional step in order to improve machine reliability, is to verify the topping up process at the machine level and its sealing conditions, in order to prevent the ingress of new contaminants. After this point, it's all about oil condition monitoring. Devices like the oil conditioning station can help to maintain the desired cleanliness level of a given machine.

Impact of cleanliness in bearing life

SKF Bearing Calculator is an online tool available from www.skf.com that can be used (among others) to calculate the expected bearing life.

Let's consider an SKF 22222 E under the following conditions:

- Radial load: 100 kN
- Axial load: 10 kN
- Rotational speed of the inner ring: 500 r/min
- Operating temperature: 70 °C
- Lubricant: ISO VG 100 mineral oil with VI 95

The expected life values for two different contamination levels are:

- ISO 4406 -/21/18: 1 060 hours
- ISO 4406 -/19/16: 1 950 hours

This means that by cleaning the oil, the bearing life is increased over 80%.

ISO contamination classification and filter rating

The standard method for classifying the contamination level in an oil is described in ISO 4406. In this classification system, the result of the solid particle count is converted into a code using a scale number.

A given oil with a code 22/18/13 for example, contains per millilitre of oil:

- 20 000 to 40 000 particles $\geq 4 \mu\text{m}$
- 1 300 to 2 500 particles $\geq 6 \mu\text{m}$
- 40 to 80 particles $\geq 14 \mu\text{m}$

Sometimes, only the two larger particle size ranges are used.

Effect of oil cleanliness in bearing life



Cleanliness level
ISO -/21/18

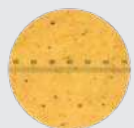

Cleanliness level
ISO -/19/16

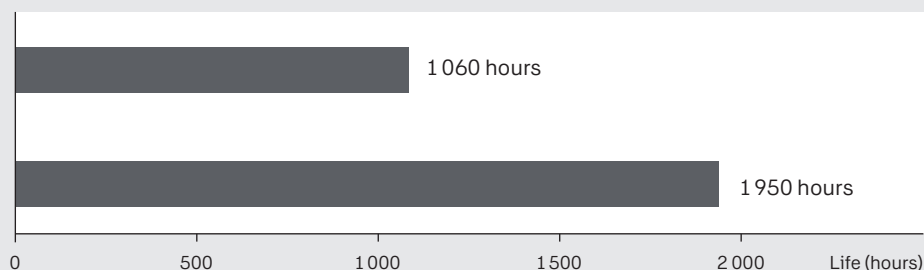



Features

- **Tanks** – Built in aluminized steel and available in 10 different colours and four sizes: 113, 246, 454 and 908 litre (30, 65, 120 and 240 US gal)
- **Scalable and configurable** – scale system to accommodate the number of lubricants required for storage and dispensing
- **Spill control** – all systems come standard with integrated spill pans for SPCC and EPA compliance and overall environmental protection
- **Fire suppression** – includes MSHA-CFR30 – rated flame resistant fire suppression hoses as standard with optional fusible link tank isolation valves and auto-shut off taps
- **Filtration** – all systems come with fluid filtration capability with a choice of micron ratings and also desiccant air breathers. Filter micron rating must be chosen according with cleanliness level targets and oil viscosity. Ask SKF for further assistance
- **All systems ship in fully assembled pods** – for efficient freight and rapid on-site installation
- **Transport** – all systems have integrated spill transport pallets for easy forklift and hand truck access for freight and workplace mobility

- **Power** – all systems can be equipped with 110 V/220 V, 50 Hz / 60 Hz motors, according with customer's specifications
- **High viscosity** – Each tank is equipped with an individual high viscosity pump with a flow rate of 3 US gal/min able to deliver oils up to ISO VG 680

Oil conditioning station benefits

- Helps to ensure each oil achieves the target cleanliness code (ISO 4406) prior to be delivered to the machine
- Prevents cross contamination
- Prevents the ingress of airborne particles and moisture to the stored oil
- Minimizes safety risks associated with drum handling and /or oil spillage
- Reduces risks in case of fire due to the flame resistant and fire suppression devices
- Helps to build a neat and tidy workspace

SKF offers an analysis of your current lubrication practices and proposes an improvement in various oil storage station configurations to satisfy the required application.



Standard model

- Very space efficient
- Easy relocation around the plant



Superior model

- Premium ergonomic dispensing and working surfaces
- Integrated parts, hose reels and tool storage
- Electrical protection – circuit breakers, surge protectors and motor overload protection all help to ensure safe and effective operation in demanding environments
- Numerous upgrade options

Comparison table

	Standard	Superior
SPCC spill containment	•	•
Optional Fire safety	•	•
Pressurized dispensing from taps	•	•
One pump and filter per tank	•	•
One suction hose without storage per tank (storage options as accesories)	•	•
3 way filtration – fill, re-circulate, dispense	•	•
Electrical protection – circuit breakers, surge protectors, motor overload protection	-	•
Push button emergency system stop	-	•
Independent ergonomic stainless steel dispensing console	-	•
Integrated parts and tools storage	-	•
Optional hose reels	-	•

Lubrication analysis tools



Portable grease analysis kit for field use

Grease test kit TKG1

Lubricant analysis is a vital part of a predictive maintenance strategy. Until recently, however, oils were almost always analysed despite the fact that around 80% of bearings are lubricated with grease. Tribology expertise and years of research have allowed SKF to develop a complete methodology to assess grease condition.

- Extremely useful in field decision-making processes
- Allows adjustment of grease relubrication intervals according to real conditions
- Grease can be evaluated to detect possible unacceptable deviations from batch to batch
- Allows verification of the suitability of certain greases in specific applications
- Helps in the prevention of damage due to underperforming lubricant greases
- Provides more information on root cause analysis
- Requires no special training to perform the tests
- Requires no harmful chemicals
- Small sample sizes required. Only 0.5 g of grease is needed to perform all the tests

Consistency test
(Patent applied for)



Oil bleeding characteristics



Contamination evaluation

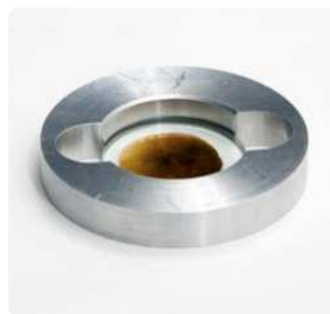

Technical data			
Designation	TKGT 1		
Parts	Components	Quantity	Specifications
Sampling tools	Sampling syringe	1	Polypropylene
	Sampling tube	1	PTFE, length approx. 1 m
	Permanent marker	1	Black
	Sampling containers	10	35 ml polyethylene
	Gloves	10 pairs	Grease resistant nitrile (synthetic rubber), powder free, size XL, colour blue
	Disposable spatulas	1	Set of 25
	250 mm stainless steel spatula	1	Stainless steel
	150 mm stainless steel spatula	1	Stainless steel
	Scissors	1	Stainless steel
Consistency test	Housing	1	Aluminium
	Weight	1	Stainless steel
	Mask	1	Plexiglas
	Glass plates	4	
Oil bleeding test	Grease sample heater	1	24W 100-240 V 50/60 Hz
	Power plug adapter	1	AC/DC Adapter (US, UK, Australia)B
	Paper pack	1	Contains 50 sheets
	Ruler	1	Aluminium graduated 0.5 mm
Contamination test	Pocket microscope	1	60–100x with light
	Batteries	2	AAA
Carrying case	IFU leaflet	1	Provides access to the instructions for use, report template, and consistency test scale
	Carrying case	1	Dimensions: 530 × 110 × 360 mm (20.9 × 4.3 × 14.2 in.)



Oil check monitor TMEH 1

The SKF TMEH 1 measures the changes in dielectric constant of an oil sample. By comparing measurements obtained from used and fresh samples of the same oil, the degree of change in the condition of the oil is established. Dielectric change is directly related to the oil's degradation and contamination level. The monitor allows tracking of mechanical wear and of any loss of the oil's lubricating properties.

- Hand-held and user friendly
- Numerical readout to facilitate trending
- Can store calibration (good oil) in its memory
- Shows changes in oil condition affected by such things as:
 - Water content
 - Fuel contamination
 - Metallic content
 - Oxidation



Note

The SKF Oil Check Monitor is not an analytical instrument. It is an instrument to only detect changes in the oil condition. The visual and numerical read-outs are merely a guide to enable trending of the comparative readings of a good oil to a used oil of the same type and brand. Do not rely solely on numerical readings.

Technical data

Designation	TMEH 1
Suitable oil types	mineral and synthetic oils
Repeatability	±5%
Readout	green/red grading + numerical value (–999 to +999)
Battery	9 V Alkaline type IEC 6LR61
Battery lifetime	>150 hours or 3 000 tests
Product dimensions	250 × 32 × 95 mm (9.8 × 1.3 × 3.7 in.)
Carrying case dimensions	530 × 85 × 180 mm (20.9 × 3.4 × 7.0 in.)

Lubrication software

For access or download: visit skf.com

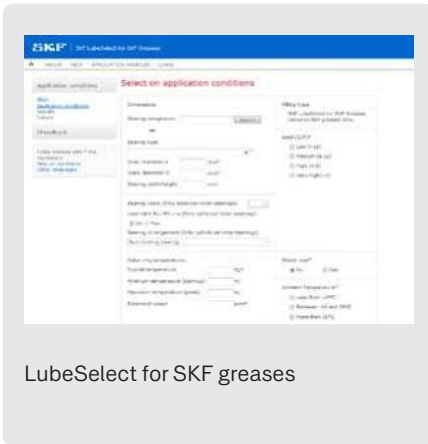

LubeSelect for SKF greases

Advanced tool for grease selection and relubrication calculation

LubeSelect for SKF greases

Selecting a suitable grease for a particular bearing is a crucial step if the bearing is to meet design expectations in its application. SKF knowledge about bearing lubrication has been encapsulated into a computer program that can be consulted at skf.com/lubeselect

LubeSelect for SKF greases provides you a user friendly tool to select the right grease and suggest frequency and quantity, while taking into account the particular conditions of your application. General guidelines for typical greases for different applications are also available.



SKF Lubrication Planner

A user friendly tool to administer your lubrication plan

SKF Lubrication planner

The SKF Lubrication Planner has been developed to help in the administration of a lubrication plan, thereby bridging the gap between the need for a software platform vs. administration by a simple spreadsheet.

- Establish a mapping of lubrication points
- Create a colour coded identification system
- Get expert advice on grease selection
- Calculate relubrication quantities and intervals
- Discover the benefits of dynamic route planning
- Get expert advice on best lubrication procedures
- Keep the history of performed lubrication tasks per point

SKF Lubrication Planner is available in several languages.

Download it for free at www.skf.com/group/digital-tools/run-and-maintain/lubrication-planner



SKF DialSet is available free-of-charge at dialset.skf.com

Quick tool for relubrication calculation

SKF DialSet

SKF DialSet has been designed to help you to set up your SKF automatic lubricators. After selecting the criteria and grease appropriate for your application, the program provides you with the correct settings for your SKF automatic lubricators. It also provides a quick and simple tool for relubrication intervals and quantity calculations.

- Allows quick calculation of the relubrication intervals based on the operating conditions of your application
- Calculations are based on SKF lubrication theories
- Calculated lubrication intervals depend on the properties of the selected grease, thereby minimising the risk of under- or overlubrication and optimising grease consumption
- Calculations take into account SKF automatic lubrication systems, grease dispense rates, thus facilitating the selection of the correct lubricator setting
- Recommended grease quantity depends on the grease replenishment position; side or W33 for optimum grease consumption
- Includes a complete list of the SKF SYSTEM 24 accessories

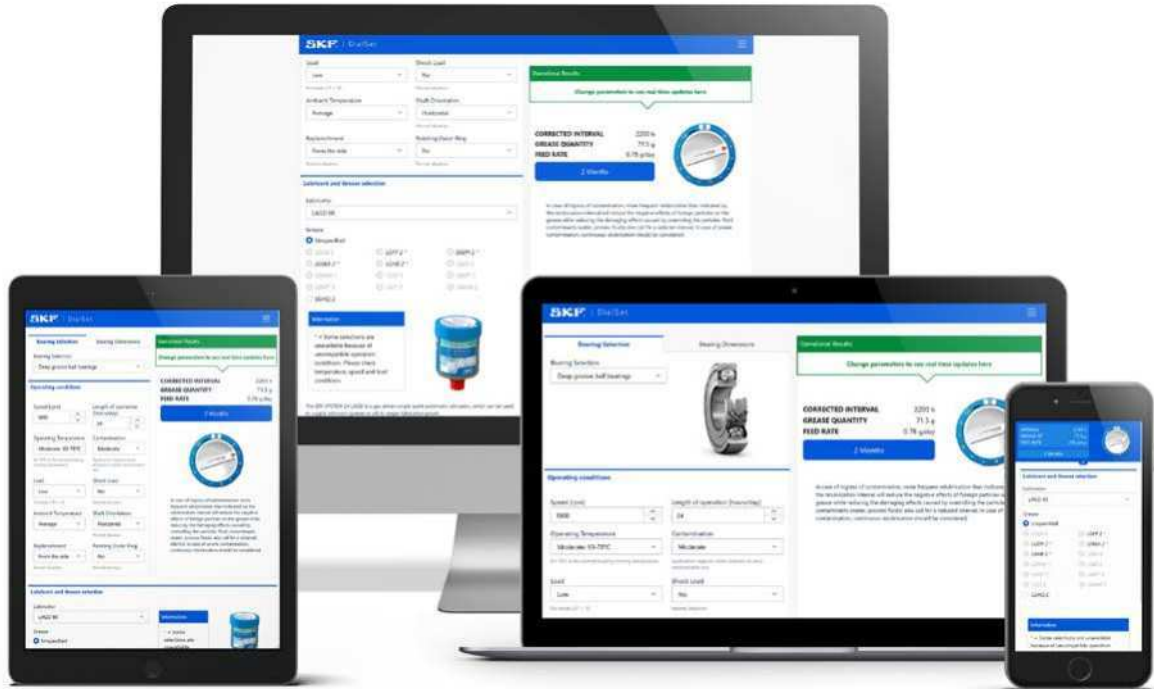

Designation index

Designation	Description	Page	Designation	Description	Page
226400 E/400	Oil injector.....	69	HMVC ..E series	Hydraulic nuts, inch thread series	60
226400 E	Oil injector.....	69	HMV ..E series	Hydraulic nuts.....	60
226402	Adapter block	69	HN 4-16/SET	Hook spanner set.....	12
227965/100MPA	Extension pipe.....	77	HN A series	Adjustable hook spanners	13
227966/100MPA	Extension pipe.....	77	HN series	Hook spanners.....	13
228027 E	Nipple with pipe thread (G)	74	HN SNL series	Hook spanners for SKF housings.....	14
233950 E	Plug for oil ducts and vent holes.....	77	LABP 5-16/2K	Elevator lubricator kit	191
234063/50MPA	Connection nipple.....	77	LAGC S	Grease coupler.....	201
234064/50MPA	Extension pipe.....	77	LAGD 60	Gas driven automatic lubricator.....	176
728619 E	Hydraulic pump.....	67	LAGD 125	Gas driven automatic lubricator.....	176
729100	Quick connection nipple	73	LAGF 18	Grease filler pump	198
729101-CK1	Hose conversion kit.....	76	LAGF 50	Grease filler pump	198
729101-HC1	Swivel adapter.....	75	LAGG 18AE	Mobile grease pump.....	199
729106/100MPA	Connection nipple (NPT and G)	74	LAGG 18M	Grease pump.....	199
729124 DU	Hydraulic pump with digital gauge	58	LAGG 50AE	Grease pump.....	199
729124	Hydraulic pump.....	66	LAGG 180AE	Grease pump.....	199
729126	Pressure hose.....	72	LAGH 400	Grease gun	193
729146	Nipple with pipe thread (G)	74	LAGM 1000E	Grease meter.....	198
729654/150MPA	Connection nipple (NPT and G)	74	LAGN 120	Grease nipples.....	200
729655/150MPA	Connection nipple (NPT and G)	74	LAGS 8	Grease nozzles.....	200
729656/150MPA	Connection nipple (NPT and G)	74	LAGT 18-50	Trolley for 18-50 kg drums.....	199
729659 C	Electric hot plate.....	41	LAGT 180	Trolley for 180 kg drums.....	199
729831 A	Quick connection coupling	73	LAHD 500	Oil leveller.....	203
729832 A	Quick connection nipple.....	73	LAHD 1000	Oil leveller.....	203
729834	Pressure hose.....	72	LAOS series	Oil handling containers	204
729865 A	Feeler gauge	80	LAPA 45	Angle connection 45°	190
729865 B	Feeler gauge	80	LAPA 90	Angle connection 90°	190
729944 E	Plug for oil ducts and vent holes.....	77	LAPB 3x4E1	Brush 30 × 40 mm	191
1008593 E	Nipple with pipe thread (G)	74	LAPB 3x7E1	Brush 30 × 60 mm	191
1009030 B	Nipple with pipe thread (G)	74	LAPB 3x10E1	Brush 30 × 100 mm	191
1009030 E	Nipple with pipe thread (G)	74	LAPB 5-16E1	Elevator brush, 5–16 mm gap	191
1012783 E	Nipple with pipe thread (G)	74	LAPC 13	Bracket	191
1014357 A	Nipple with pipe thread (G)	74	LAPC 50	Clamp	191
1016402 E	Nipple with pipe thread (G)	74	LAPC 63	Clamp	191
1018219 E	Nipple with pipe thread (G)	74	LAPE 35	Extension 35 mm	190
1018220 E	Nipple with pipe thread (G)	74	LAPE 50	Extension 50 mm	190
1019950	Nipple with pipe thread (G)	74	LAPF F 1/4	Tube connection female G 1/4.....	190
1030816 E	Plug for oil ducts and vent holes.....	77	LA PF M 1/4 S	Tube connection male G 1/4 for 6 × 4 tube.....	190
1077453/100MPA	Extension pipe.....	77	LAPF M 1/4SW	Extra strong tube connection male G 1/4.....	190
1077454/100MPA	Connection nipple.....	77	LAPF M 1/4	Tube connection male G 1/4.....	190
1077455/100MPA	Nipple with pipe thread (G)	74	LAPF M 1/8 S	Tube connection male G 1/8 for 6 × 4 tube.....	190
1077456/100MPA	Nipple with pipe thread (G)	74	LAPF M 1/8	Tube connection male G 1/8.....	190
1077587/2	Pressure gauge	71	LAPF M 3/8	Tube connection male G 3/8.....	190
1077587	Pressure gauge	71	LAPG 1/4	Grease nipple G 1/4	190
1077589/3	Pressure gauge	71	LAPM 2	Y-connection.....	190
1077589	Pressure gauge	71	LAPN 1/2	Nipple G 1/4 – G 1/2.....	190
1077600	Grease gun.....	192	LAPN 1/4	Nipple G 1/4 – G 1/4.....	190
1077600H	Grease gun with hose.....	193	LAPN 1/4 UNF	Nipple G 1/4 – 1/4 UNF	190
1077600/SET	Grease gun set.....	193	LAPN 1/8	Nipple G 1/4 – G 1/8	190
1077601	Flexible hose	193	LAPN 3/8	Nipple G 1/4 – G 3/8	190
EAZ series	Fixed induction heaters.....	52	LAPN 6	Nipple G 1/4 – M6	190
HMVA 42/200	Hydraulic nut drive-up adapter	59	LAPN 8	Nipple G 1/4 – M8	190

Designation	Description	Page
LAPN 8x1	Nipple G1/4 – M8 × 1	190
LAPN 10	Nipple G1/4 – M10	190
LAPN 10x1	Nipple G1/4 – M10 × 1	190
LAPN 12	Nipple G1/4 – M12	190
LAPN 12x1.5	Nipple G1/4 – M12 × 1,5	190
LAPP 4	Protection base	191
LAPP 6	Protection cap	191
LAP.. series	Accessories for SKF automatic lubricators	190
LAPT 1000	Flexible tube, 1 000 mm long, 8 × 6 mm	191
LAPT 1000S	Extra strong flexible tube, 1 000 mm long, 6 × 4 mm	191
LAPT 1000SW	Extra strong flexible tube, 1 000 mm long, 8 × 6 mm	191
LAPT 5000	Flexible tube, 5 000 mm long, 8 × 6 mm.....	191
LAPT 5000S	Extra strong flexible tube, 5 000 mm long, 6 × 4 mm	191
LAPT 5000SW	Extra strong flexible tube, 5 000 mm long, 8 × 6 mm	191
LAPV 1/4	Non-return valve G1/4.....	191
LAPV 1/8	Non-return valve G1/8	191
LDTS 1	Dry film lubricant	167
LFFM 100	General purpose food grade chain oil	166
LFFT 220	High temperature food grade chain oil	166
LGAF 3E	Anti-fretting agent	39
LGCC 2	General purpose lubrication systems grease.....	170
LGED 2	High temperature food grade grease.....	165
LGEM 2	High viscosity grease	155
LGEP 1	Extreme pressure grease.....	153
LGEP 2	High load, extreme pressure grease	146
LGEP 2	Extreme high temperature grease	161
LGEV 2	Extremely high viscosity grease	156
LGFG 2	General purpose food grade grease.....	163
LGFQ 2	High load food grade grease	164
LGGB 2	EAL Biodegradable grease.....	150
LGHB 2	High viscosity, high temperature grease.....	157
LGHC 2	High load, high temperature grease.....	158
LGHP 2	High performance grease.....	159
LGHQ 2	Electric motor grease	160
LGLS 0	Wide temperature lubrication systems grease.....	171
LGLS 2	High viscosity lubrication systems grease.....	172
LGLT 2	Low temperature, high speed grease.....	151
LGMT 2	General purpose grease.....	144
LGMT 3	General purpose grease.....	145
LGNL 2	General purpose, high load industrial grease.....	147
LGNL 3	General purpose, high load grease.....	148
LGTE 2	Biodegradable grease for total loss applications.	169
LGWA 2	High load, extreme pressure grease	149
LGWM 1	Extreme pressure, low temperature grease.....	152
LGWM 2	High load, wide temperature grease.....	154
LHDF 900	Dismounting fluid	81
LHHT 250	High temperature chain oil.....	173
LHMF 300	Mounting fluid.....	81
LHMT 68	Medium temperature chain oil	173

Designation	Description	Page
LMCG 1	Grid and gear coupling grease.....	168
Oil storage station	Oil conditioning/storage station.....	206
SKF DialSet	Re-lubrication calculation program.....	211
SKF LubePlanner	Lubrication planning program.....	210
SKF LubeSelect	Grease selection and calculation program	210
SKF QuickCollect	Bluetooth sensor.....	127
SM ..-E CS	SKF Vibracon adjustable chocks Carbon steel series.....	100
SM ..-E CSTR	SKF Vibracon adjustable chocks Surface treated carbon steel series.....	100
SM ..-ELP ASTR	SKF Vibracon adjustable chocks Low profile series.....	100
SM ..-E SS	SKF Vibracon adjustable chocks Stainless steel series.....	100
SMSW ..-ASTR	Spherical washers series.....	102
SMSW ..LPAST	Spherical washers - Low profile series.....	102
THAP 030E	Air-driven pump	70
THAP 030E/SK1	Air-driven pump set	70
THAP 150E	Air-driven pump	70
THAP 150E/SK1	Air-driven pump set	70
THAP 300E	Air-driven injector.....	70
THAP 300E/K10	Air-driven injector set.....	70
THAP 300-H/3	Pressure hose.....	72
THAP 300-H/4	Pressure hose.....	72
THAP 300-HK1	Hose conversion kit.....	76
THAP 400E	Air-driven injector.....	70
THAP 400E/K10	Air-driven injector set.....	70
THAP 400-H/2	Pressure hose.....	72
THAP 400-H/3	Pressure hose.....	72
THAP 400-H/4	Pressure hose.....	72
THAP 400-HK1	Hose conversion kit.....	76
THGD 100	Digital oil pressure gauge.....	71
THHP 300-2H/3	Pressure hose.....	72
THHP 300-2H/4	Pressure hose.....	72
THHP 300-2H	Pressure hose.....	72
THHP 300	Hydraulic pump.....	68
THPA AM12/G1/4	Nipple for rigid pipe.....	78
THPA AM12/G1/8	Nipple for rigid pipe.....	78
THPA AM12/G3/4	Nipple for rigid pipe.....	78
THPA AM12/M16	Nipple for rigid pipe.....	78
THPA M12/B	Rigid pipe for hose connection.....	78
THPA M12/C	Rigid pipe for hose connection.....	78
THPA M12/D	Rigid pipe for hose connection.....	78
THPA M12	Rigid pipe for hose connection.....	78
THPC 300-1	Quick connection coupling	73
THPC 400-1	Quick connection coupling	73
THPN 300-1	Quick connection nipple	73
THPN 400-1	Quick connection nipple	73
THPN FM16G3/4	Application connection nipple.....	75
THPN M16G1/2	Application connection nipple.....	75
THPN M16G1/4	Application connection nipple.....	75
THPN M16G1/8	Application connection nipple.....	75
THPN M16G3/4	Application connection nipple.....	75

Designation index

Designation	Description	Page
THPN M16G3/8	Application connection nipple.....	75
TIH 030m	Induction heater.....	45
TIH 030m	Induction heater.....	47
TIH 100m	Induction heater.....	45
TIH 100m	Induction heater.....	47
TIH 220m	Induction heater.....	45
TIH 220m	Induction heater.....	47
TIH L33	Induction heater.....	46
TIH L33MB	Solid workpiece heater.....	48
TIH L44	Induction heater.....	46
TIH L44MB	Solid workpiece heater.....	48
TIH L77	Induction heater.....	46
TIH L77MB	Solid workpiece heater.....	48
TIH MC series	Multi-core induction heaters.....	49
TKBA 11	Belt alignment tool.....	104
TKBA 21	Belt alignment tool.....	104
TKBA 31	Belt alignment tool.....	105
TKBA 40	Belt alignment tool.....	106
TKDT 10	Contact thermometer.....	111
TKED 1	Electrical discharge detector pen.....	126
TKES 10A	Video endoscope with articulating tip tube.....	124
TKES 10F	Video endoscope with flexible tube.....	124
TKES 10S	Video endoscope with semi-rigid tube.....	124
TKGT 1	Grease test kit.....	208
TKRS 11	Stroboscope.....	120
TKRS 21	Stroboscope.....	120
TKRS 31	Stroboscope.....	120
TKRS 41	Stroboscope.....	120
TKRT 10	Tachometer.....	116
TKRT 21	Tachometer.....	116
TKRT 31	Tachometer.....	116
TKSA 11	Shaft alignment tool.....	88
TKSA 31	Shaft alignment tool.....	89
TKSA 31	Shaft alignment tool.....	103
TKSA 41	Shaft alignment tool.....	90
TKSA 51	Shaft alignment tool.....	91
TKSA 71/PRO	Shaft alignment tool.....	92
TKSA 71	Shaft alignment tool.....	92
TKSA accessories	Accessories for TKSA shaft alignment tools.....	95
TKST 11	Stethoscope.....	122
TKST 21	Stethoscope.....	122
TKSU 10	Ultrasonic leak detector.....	119
TKTL 11	Infrared thermometer.....	112
TKTL 21	Infrared and contact thermometer.....	112
TKTL 31	Infrared and contact thermometer.....	112
TKTL 40	Infrared and contact thermometer.....	113
TLAC 50	Grease fitting caps and tags.....	201
TLDD 1/-DS	Drive unit for connected automatic lubricator.....	182
TLDD 1/-GAT	Gateway for connected automatic lubricator.....	182
TLDD 2/-GAT	Gateway for connected automatic lubricator.....	182
TLDD series	Connected automatic lubricator.....	182
TLGB 21/110V	Battery driven grease gun.....	194

Designation	Description	Page
TLGB 21/230V	Battery driven grease gun.....	194
TLGB 1262-E	Battery driven grease gun.....	196
TLGB 1886-E	Battery driven grease gun.....	197
TLGH 1	Grease gun.....	192
TLGU 10	Ultrasound lubrication checker.....	202
TLMP 1008	Multi point automatic lubricator.....	188
TLMP 1018	Multi point automatic lubricator.....	188
TLMR 101/38WA2	Lubricator with 380 ml cartridge filled with LGWA 2 grease powered by batteries.....	186
TLMR 101	Electro-mechanical automatic lubricator powered by batteries.....	186
TLMR 201-1	Cable plug M12x1 for TLMR 201, type M12-A.....	191
TLMR 201/38WA2	Lubricator with 380 ml cartridge filled with LGWA 2 grease powered by 12-24 V DC.....	186
TLMR 201	Electro-mechanical automatic lubricator powered by 12-24 V DC.....	186
TLRD 1-FA	Filling adapter (for TLRDI cartridges).....	185
TLRD 150	Refillable automatic grease dispenser.....	185
TLRD 250	Refillable automatic grease dispenser.....	185
TLSD 1-BAT	Alkaline battery pack for TLSD/TLDD.....	191
TLSD 1-BATC	Lithium battery pack for TLSD/TLDD.....	191
TLSD 1-DK	Electric drive unit for automatic lubricator.....	180
TLSD 1-DS	Battery-driven drive unit for automatic lubricator.....	178
TLSD 125	Electro-mechanical driven automatic lubricator.....	178
TLSD 250	Electro-mechanical driven automatic lubricator.....	178
TMAS 50/KIT	Machinery shims kit.....	99
TMAS 75/KIT	Machinery shims kit.....	99
TMAS 100/KIT	Machinery shims kit.....	99
TMAS 340	Machinery shims kit.....	99
TMAS 360	Machinery shims kit.....	99
TMAS 380	Machinery shims kit.....	99
TMAS 510	Machinery shims kit.....	99
TMAS 720	Machinery shims kit.....	99
TMAS series	Machinery shims.....	98
TMBA G11ET	Extreme heat resistant gloves.....	54
TMBA G11	Heat resistant gloves.....	54
TMBA G11H	Heat and oil resistant gloves.....	54
TMBH 5/120V	Compact portable induction heater.....	42
TMBH 5/230V	Compact portable induction heater.....	42
TMBP 20E	Blind housing puller kit.....	30
TMBR series	Aluminium heating ring series.....	50
TMBS 50E	Strong back puller.....	29
TMBS 100E	Strong back puller.....	29
TMBS 150E	Strong back puller.....	29
TMCD 5P	Vertical dial indicator.....	58
TMCD 10R	Horizontal dial indicator, mm.....	58
TMDC 1/2R	Horizontal dial indicator, in.....	58
TMDT 2-30	Standard surface probe.....	115
TMDT 2-31	Magnetic surface probe.....	115
TMDT 2-33	Right angle surface probe.....	115
TMDT 2-34/1.5	Gas and liquid probe.....	115
TMDT 2-34	Gas and liquid probe.....	115
TMDT 2-35	Probe with sharp tip.....	115

Designation	Description	Page	Designation	Description	Page
TMDT 2-36	Pipe clamp probe.....	115	TMMP 2x65	Standard jaw puller.....	24
TMDT 2-37	Extension cable.....	115	TMMP 2x170	Standard jaw puller.....	24
TMDT 2-38	Wire probe.....	115	TMMP 3x185	Standard jaw puller.....	24
TMDT 2-39	High temperature wire probe.....	115	TMMP 3x230	Standard jaw puller.....	24
TMDT 2-40	Rotating probe.....	115	TMMP 3x300	Standard jaw puller.....	24
TMDT 2-42	Ambient temperature probe.....	115	TMMP 6	Heavy duty jaw puller.....	24
TMDT 2-43	Heavy duty surface probe.....	115	TMMP 10	Heavy duty jaw puller.....	24
TMEH 1	Oil check monitor.....	209	TMMP 15	Heavy duty jaw puller.....	24
TMFN series	Impact spanners.....	16	TMMR 4F/SET	Reversible jaw puller set.....	27
TMFS series	Axial lock nut sockets.....	15	TMMR 8F/SET	Reversible jaw puller set.....	27
TMFT 36	Bearing fitting tool.....	10	TMMR 8XL/SET	Reversible jaw puller set.....	27
TMFT 36-H	Dead blow hammer.....	10	TMMR 40F	Reversible jaw puller.....	26
TMHC 110E	Hydraulic puller kit.....	28	TMMR 60F	Reversible jaw puller.....	26
TMHK 35	Mounting/dismounting kit for OK Couplings.....	82	TMMR 80F	Reversible jaw puller.....	26
TMHK 36	Mounting/dismounting kit for OK Couplings.....	82	TMMR 80F	Reversible jaw puller.....	27
TMHK 37E	Mounting/dismounting kit for OK Couplings.....	82	TMMR 120F	Reversible jaw puller.....	26
TMHK 37F	Mounting/dismounting kit for OK Couplings.....	82	TMMR 160F	Reversible jaw puller.....	26
TMHK 37S	Mounting/dismounting kit for OK Couplings.....	82	TMMR 160XL	Reversible jaw puller.....	26
TMHK 37T	Mounting/dismounting kit for OK Couplings.....	82	TMMR 200F	Reversible jaw puller.....	26
TMHK 38F	Mounting/dismounting kit for OK Couplings.....	83	TMMR 200XL	Reversible jaw puller.....	26
TMHK 38	Mounting/dismounting kit for OK Couplings.....	82	TMMR 250F	Reversible jaw puller.....	26
TMHK 38R	Mounting/dismounting kit for OK Couplings.....	83	TMMR 250XL	Reversible jaw puller.....	26
TMHK 38S	Mounting/dismounting kit for OK Couplings.....	83	TMMR 350F	Reversible jaw puller.....	26
TMHK 38T	Mounting/dismounting kit for OK Couplings.....	83	TMMR 350XL	Reversible jaw puller.....	26
TMHK 39	Mounting/dismounting kit for OK Couplings.....	83	TMMS 50	Tri-section pulling plate.....	37
TMHK 40	Mounting/dismounting kit for OK Couplings.....	83	TMMS 100	Tri-section pulling plate.....	37
TMHK 41	Mounting/dismounting kit for OK Couplings.....	83	TMMS 160	Tri-section pulling plate.....	37
TMHN 7	Bearing lock nut spanner.....	17	TMMS 260	Tri-section pulling plate.....	37
TMHP 10E	Hydraulic jaw puller kit.....	27	TMMS 380	Tri-section pulling plate.....	37
TMHP 15 series	Hydraulically assisted heavy duty jaw puller.....	25	TMMX 210	Puller protection blanket.....	38
TMHP 30 series	Hydraulically assisted heavy duty jaw puller.....	25	TMMX 210	Puller protection blanket.....	40
TMHP 50 series	Hydraulically assisted heavy duty jaw puller.....	25	TMMX 280	Puller protection blanket.....	38
TMHS 75	Advanced hydraulic spindle.....	36	TMMX 280	Puller protection blanket.....	40
TMHS 100	Advanced hydraulic spindle.....	36	TMMX 350	Puller protection blanket.....	38
TMIC 7-28	Internal bearing puller kit.....	32	TMMX 350	Puller protection blanket.....	40
TMIP 7-28	Internal bearing puller kit.....	32	TMWX 15/110V	Portable induction heater.....	43
TMIP 7-60	Internal bearing puller kit.....	32	TMWX 15/230V	Portable induction heater.....	43
TMIP 30-60	Internal bearing puller kit.....	32	VKN 550	Bearing packer.....	200
TMJL 50DU	Hydraulic pump with digital gauge.....	58			
TMJL 50	Hydraulic pump.....	66			
TMJL 100DU	Hydraulic pump with digital gauge.....	58			
TMJL 100	Hydraulic pump.....	67			
TMMA 60	SKF EasyPull -Mechanical jaw puller.....	22			
TMMA 75H/SET	SKF EasyPull -Hydraulic jaw puller set.....	23			
TMMA 75H	SKF EasyPull -Hydraulic jaw puller.....	22			
TMMA 80	SKF EasyPull -Mechanical jaw puller.....	22			
TMMA 100H/SET	SKF EasyPull -Hydraulic jaw puller set.....	23			
TMMA 100H	SKF EasyPull -Hydraulic jaw puller.....	22			
TMMA 120	SKF EasyPull -Mechanical jaw puller.....	22			
TMMD 100	Deep groove ball bearing puller kit.....	31			
TMMK 10-35	Combi kit.....	18			
TMMK 20-50	Combi kit.....	18			



SKF Maintenance and Lubrication Products

Our mission is to maximize our customer bearing performance through effective lubrication and maintenance solutions.



skf.com | skf.com/mapro | skf.com/lubrication

- © SKF, SYSTEM 24 and VIBRACON are registered trademarks of AB SKF (publ). KEVLAR is a registered trademark of DuPont. Microsoft and Windows are either registered trademarks or trademarks of Microsoft Corporation in the United States and/or other countries. App Store is a service mark of Apple Inc. registered in the US and other countries. Android and Google Play are trademarks of Google Inc.

© SKF Group 2025. All rights reserved. Please note that this publication may not be copied or distributed, in whole or in part, unless prior written permission is granted.

Every care has been taken to ensure the accuracy of the information contained in this publication, but no liability can be accepted for any loss or damage whether direct, indirect or consequential arising out of the use of the information contained herein.